



NCAT Report 05-08

EVALUATION OF BOND STRENGTH BETWEEN PAVEMENT LAYERS

By

Randy C. West
Jingna Zhang
Jason Moore

December 2005



277 Technology Parkway Auburn, AL 36830

EVALUATION OF BOND STRENGTH BETWEEN PAVEMENT LAYERS

By

Randy C. West
Assistant Director
National Center for Asphalt Technology
Auburn University, Auburn, Alabama

Jingna Zhang
Research Engineer
National Center for Asphalt Technology
Auburn University, Auburn, Alabama

Jason Moore
Research Engineer
National Center for Asphalt Technology
Auburn University, Auburn, Alabama

Sponsored by

The Alabama Department of Transportation

NCAT Report 05-08

December 2005

DISCLAIMER

The contents of this report reflect the views of the authors who are responsible for the facts and accuracy of the data presented herein. The contents do not necessarily reflect the official views or policies of the Alabama Department of Transportation, the National Center for Asphalt Technology, or Auburn University. This report does not constitute a standard, specification, or regulation.

TABLE OF CONTENTS

ABSTRACT	iii
INTRODUCTION	1
PURPOSE OF THE STUDY	2
SCOPE	2
LITERATURE REVIEW	3
EXPERIMENTAL PLAN	9
TEST RESULTS AND DISCUSSION	11
CONCLUSIONS.....	46
RECOMMENDATIONS.....	47
REFERENCES	48
APPENDIX A: Laboratory Mix Designs	50
APPENDIX B: Draft Test Method for Determining Bond Strength.....	53

ABSTRACT

The primary objective of this project was to develop a test for measuring the bond strength between pavement layers. The research was also to evaluate tack coat materials and application rates for the Alabama Department of Transportation (ALDOT). The project included a laboratory phase and a field phase. For the laboratory work, the experiment included two types of emulsion (CRS-2 and CSS-1) and a PG 64-22 asphalt binder that are allowed by ALDOT's specifications. Bond strengths were measured with a shear type device at three temperatures and three normal pressure levels. Three application rates that encompassed the specification range were investigated for each tack coat. Laboratory prepared mixture samples included a coarse-graded blend and a fine-graded blend to represent two different surface textures. The effects of tack coat type, application rate, mixture type, testing temperature and normal pressure on the bond strength were evaluated.

In the laboratory phase, it was found that all of the main factors used in the test plan affected bond strength. Testing temperature had the most significant impact on bond strength. As the temperature increases, bond strength decreases significantly. Testing normal pressure affected bond strength differently for high, intermediate, and low temperatures. The PG 64-22 had higher bond strength than the two emulsions, especially for the fine-graded mixture tested at high temperature. For the range studied, tack coat with low application rates generally provided high bond strength for the fine-graded mixture. However, for the coarse-graded mixture, bond strength does not change much when application rate varies. The two mixture types provided different bond strengths. The influences of tack coat type and application rate on bond strength are different for the fine-graded and coarse-graded mixtures.

Based on the laboratory work, a draft procedure was developed for determining the bond strength between pavement layers. An easy to use procedure was selected that was believed to provide a good indication of the quality of the bond. The procedure utilizes the simple shear device developed by NCAT which is similar to bond strength devices used in several European countries. The draft procedure is based on a test temperature of 77°F and a loading rate of two inches/minute.

The draft bond strength procedure was validated in the field phase of the study. Test sections with different tack coat application rates were set up on seven paving projects. For each test section, the actual application rates were measured and cores were taken to measure the bond strength using the draft procedure. On a few projects, the measured tack coat application rates were significantly lower than the range targeted by the specifications. A key finding of the field study was that the bond strength between pavement layers is significantly enhanced for milled surfaces. Good bond strengths were obtained for both emulsion and paving grade asphalt tack coats applications.

EVALUATION OF BOND STRENGTH BETWEEN PAVEMENT LAYERS

Randy C. West, Jingna Zhang, and Jason Moore

INTRODUCTION

Poor bond between two layers of hot mix asphalt (HMA) is the cause of many pavement problems. Slippage failure (Figure 1), often occurring at locations where traffic accelerates, decelerates, or turns, is the most commonly observed problem related to poor bond between layers. It is believed that this failure results from high horizontal stress and insufficient adhesion at the interface between layers (1).



Figure 1. Slippage Failure Due to Poor Bond Between HMA Layers

Other pavement problems may also be attributed to insufficient bond between layers of HMA. Compaction difficulty, premature fatigue, top down cracking, and surface layer delamination have also been linked to poor bond between HMA layers (2).

The sole purpose of tack coats is to bond HMA layers. A variety of asphalt materials are used for tack coats. Presently, asphalt emulsions are the most used tack material throughout the world (3). However, many different grades of emulsions are used including slow set, medium set, rapid set, and quick set emulsions, high float emulsions, and polymer modified asphalt emulsions. Paving grade asphalt cements are also used for tack coats. Cutback asphalts have been used as tack coat materials, but their use has significantly declined over the past thirty years due to environmental concerns related to the volatile components. Existing literature provides little guidance on the selection of tack coat materials (4,5,6).

The proper application rate for each tack material can also be a mystery. Most specifications and construction guides provide a range for the application rate and leave it to the inspector or engineer to set the target rate (4,5,6,7). Some guidance may be given to use a heavier application when paving on an old HMA pavement or concrete pavement and use a light application or even

no tack when paving over a freshly placed HMA mat. However, for emulsions, there is often confusion as to whether the application rate is based on the total emulsion or the asphalt residue. The minimum percent asphalt residue differs for emulsion grades. Generally, the “-1” grades have a minimum residue of 55 to 57 percent, and the “-2” grades have a minimum residue of about 65 percent. Confounding the matter further, some references recommend diluting emulsions before application (8,9). Alabama Department of Transportation (ALDOT) specifications prohibit diluting of asphalt emulsions used as tack coats.

Poor construction practices for the preparation of surfaces and application of tack coats can also cause problems. The existing surface must be substantially free of dirt and construction dust for the tack coat to adhere to the existing surface and provide the desired bond between the layers. Although, a power broom or sweeper is typically used to remove surface dust, all detrimental fines may not be adequately eliminated. However, some people have suggested that some fines from HMA milling operations may be advantageous to the bonding of an overlay even without the application of a tack coat (10).

PURPOSE OF THE STUDY

The primary objective of the research study was to develop a test for evaluating the bond strength between pavement layers. A secondary goal of this study was to provide helpful information for the selection of the best type(s) of tack coat materials and optimum application rate(s).

The development of the test method for bond strength included the evaluation of testing temperature, normal pressure, tack coat type, application rate, and mixture type on bond strength of the interface between two HMA layers. A laboratory experimental design was used to accomplish this objective. At the conclusion of testing, the data was analyzed to evaluate meaningful relationships between tack type and application rate to bond strength.

Deliverables for the study were to include:

- A test method for measuring the bond between an HMA layer and another bound layer.
- A recommendation on the best tack coat type(s) and application rates for HMA construction in Alabama
- A preliminary account of typical bonds obtained for construction on Alabama roadways.
- Guidance on critical bond strengths with the selected test method.

SCOPE

The study was organized into two phases. The first phase was a laboratory experiment to refine the bond strength test device and establish a method that is capable of evaluating the influence of factors including tack coat materials, application rates, temperature, and normal pressure. Laboratory fabricated samples were prepared and tested in this phase. Based on the results of the laboratory phase, a draft method for measuring bond strength was written.

The second phase of the study was a field validation of the draft bond strength method. This phase involved setting up tack coat test sections on seven paving projects in Alabama and

obtaining cores for testing the bond strength of each section. The results of the field work were used to establish preliminary criteria for bond strengths between pavement layers.

Figure 2 shows the test plan in the form of a flow diagram. The left side of the diagram represents the laboratory phase of the project and the field phase is on the right.

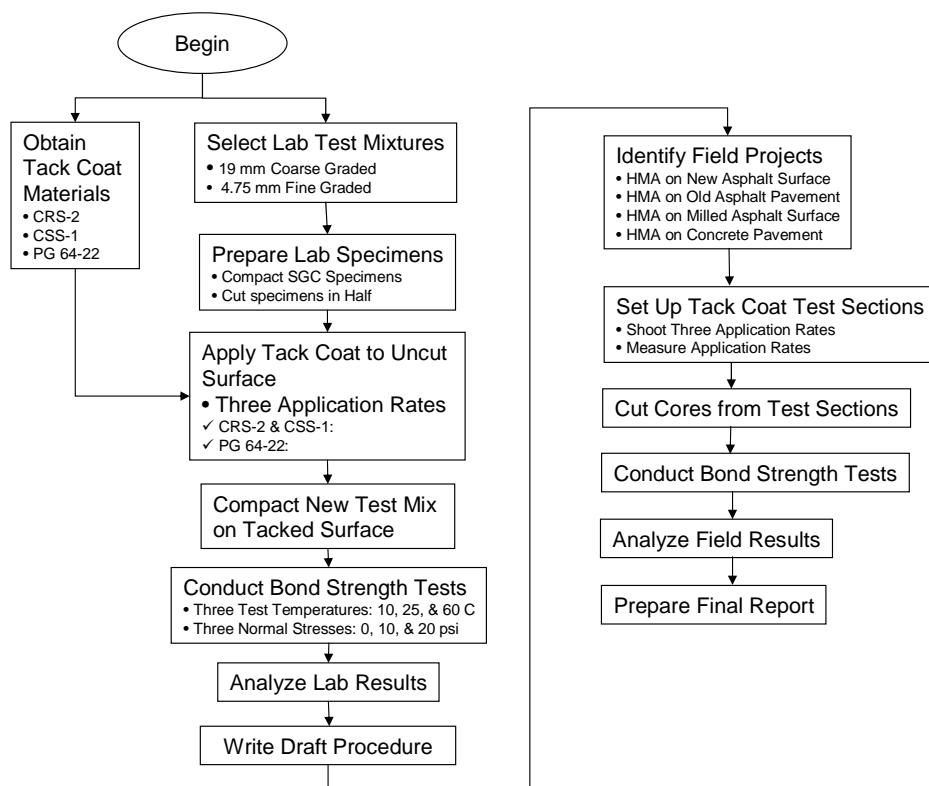

Figure 2. Test Plan for the Bond Strength Project

LITERATURE REVIEW

In 1999, the International Bitumen Emulsion Federation conducted a world-wide survey of the use of tack coats (a.k.a. bond coats). The survey requested information on the type of tack materials used, application rates, curing time, test methods, inspection methods, and construction methods. Responses were received from Spain, France, Italy, Japan, the Netherlands, the United Kingdom, and the United States. Roffe and Chaignon reported a summary of the survey (3). Cationic emulsions are the most common bond coat material, with some use of anionic emulsions. The U.S. also reported the use of paving grade asphalt cements as a tack coat. Application rates generally ranged from 0.026 to 0.088 gal/sy (0.12 to 0.40 kg/m²) based on residual asphalt. In many countries, thin surfacing layers are placed concurrently with the tack using paver-mounted spray bars. Only Austria and Switzerland have bond strength test methods and specification criteria.

Around the world, a number of studies have been conducted recently and others are underway to evaluate pavement layer bonding.

Effect of Bond on Pavement Performance

Several recent studies have evaluated the effect of the bond on pavement performance using mechanistic pavement models. In 2004, King and May presented an analysis of the effect of bond between HMA layers using the program BISAR (11). They analyzed a pavement structure with two 4-inch (100 mm) HMA layers over a 6-inch (150 mm) aggregate base and two subgrade stiffnesses. Two load levels were used, 9 kip (40 kN) dual tire and 12 kip (53.4 kN) dual tire. The interface between HMA layers was modeled in separate runs from a no slip condition to full slip between (no bond) layers. Program outputs analyzed included maximum stress and strain at various locations and numbers of load repetitions to failure. All of the outputs show a dramatic increase in stresses and strains or decrease in pavement life when the interface drops from full bond to about 90 percent bond. Figure 3 shows fatigue life decreasing by about 50 percent for each load/subgrade condition when the bond is reduced by 10 percent.

Roffe and Chaignon (3) conducted a similar analysis using the French pavement design program ALIZE. They analyzed a pavement structure consisting of a 2.4 inch (60 mm) surface layer, a 5.1 inch (130 mm) HMA intermediate layer and 7.9 inch (200 mm) aggregate base. The program was run with full bond and no bond between the HMA layers. Their analysis showed that the service life of the pavement was reduced from 20 years to between 7 and 8 years due to the lack of bond between the HMA layers.

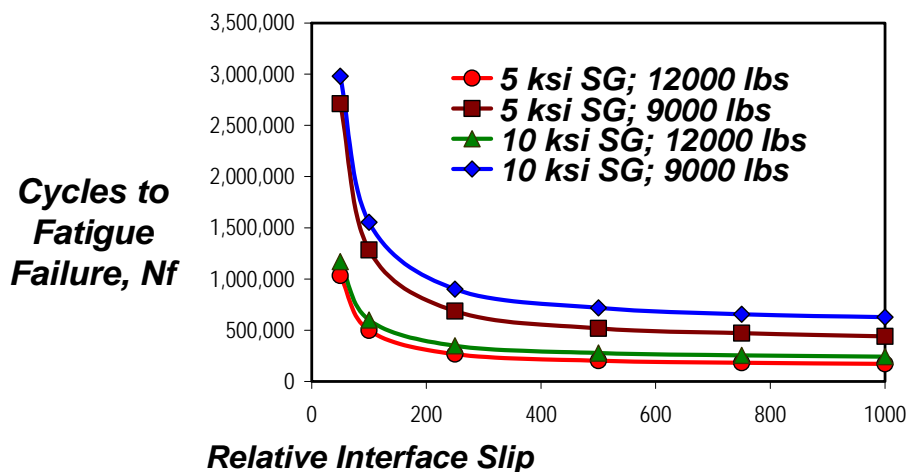

Figure 3. Effect of bond of HMA layers on fatigue life

Tests to Evaluate Bond Strength

In 1978, Uzan, et al. (12) used a direct shear test, also called interface shear mold, to test a Pen 60-70 as a tack coat. Tests were conducted on two asphalt binder layers at two different test temperatures 77 and 131°F (25 and 55°C), five application rates, and five vertical pressures. The

samples were sheared at constant horizontal displacement of 0.1 inches/min (2.5 mm/min). The optimum application rates for 77 and 131°F (25 and 55°C) were 0.11 gal/yd² and 0.22 gal/yd² (0.5 L/m² and 1.0 L/m²), respectively.

At Delft University of Technology, Molenaar et al (13) used a shear test for evaluating the shear resistance between HMA layers with several treatments including stress absorbing interlayers with and without a tack coat. The shear test device held the bottom part of the compacted cylinder and a shear load applied perpendicular to the axis of the cylinder of the top layer to measure the shear resistance at the interface between the layers. A Marshall stability loading press was used to apply the load at a rate of 0.85 mm/sec. Tests were performed on four inch (101.4 mm) diameter cores at 59°F (15°C). One of the conclusions they reported was that the shear resistance at the interface without tack was about the same as with tack.

The Swiss Federal Laboratories for Materials Testing and Research has a standard method and criteria for evaluating the bond strength of HMA layers using 6 inch (150 mm) diameter cores (3). The method is Swiss Standard SN 671 961 and uses a device known as the LPDS tester (Figure 4). The test is a simple shear test with a loading rate of 2.0 inches/min (50.8 mm/min). The minimum shear force criteria is 3372 lbf (15 kN) for the bond between thin surface layers and the binder course, and 2698 lbf (12 kN) for the bond between binder courses and road bases.



Figure 4. Swiss LPDS Tester

Following the investigation of several problems with airport surface courses in Japan, Hachiya and Sato conducted a study on the effect of tack coat and surface cleanliness on the bond between HMA layers (1). The primary location of the airfield pavement problems were in areas where the aircraft were braking or turning at high speeds. They modeled the stress conditions at the interface under a Boeing 747. They concluded from this analysis that the surface course would fail when it separated from the lower layer under high horizontal forces exerted by the aircraft. Two options were recommended to overcome this problem: increasing the thickness of the surface course or increasing the bond strength between layers. Their laboratory tests included shear type tests on rectangular blocks and cylinders. Factors investigated included test temperature, loading rate, application rate, and curing period. Two types of emulsion tack coat were evaluated, one was a typical asphalt emulsion and the other was a rubberized asphalt emulsion.

The results showed the tack coat to have relatively small effect at 20°C but did improve the bond strength at 40°C. However, the bond strength with the tack coat at 40°C was less than that for constructing the second layer on top of a hot (40°C) lower layer. Loading rate was a significant factor on bond strength, with the fast loading rate 4 in/min yielding much higher bond strengths than 0.04 in/min. Surprisingly, contamination of the surface with dirt had a negligible effect if the tack application was properly cured. However, if not properly cured, no emulsion was found

to be effective in bonding the layers. The highest bond strength was achieved with a new rubberized asphalt emulsion applied at a rate of 0.044 gal/yd² (0.2 L/m²).

Mohammad et al. (14) evaluated the influences of tack coat types, application rates, and test temperature on the interface shear strength using the Superpave Shear Tester (SST) (Figure 5, 6). Their shear apparatus had two parts that held specimens during testing. The shearing apparatus was mounted inside the SST. Shear load was applied at a constant rate of 50 lb/min (222.5 N/min) on the specimen until failure. Tests were conducted at 77 and 131°F (25 and 55°C). Tack coat materials included four emulsions (CRS-2P, SS-1, CSS-1, and SS-1h) and two asphalt binders (PG 64-22 and PG 76-22M) applied at five different rates from 0.0 to 0.2 gal/yd² (0.0 to 0.9 L/m²). Their work identified the CRS-2P emulsion as the best performer in terms of interface shear strength and its optimum application rate was 0.02 gal/yd² (0.09 L/m²). Their results also show that tests at 77°F yielded shear strengths generally about five times the shear strengths at 131°F. The tests at 77°F were also better at distinguishing differences in the application rates.



Figure 5. Shear Box with Prepared Sample

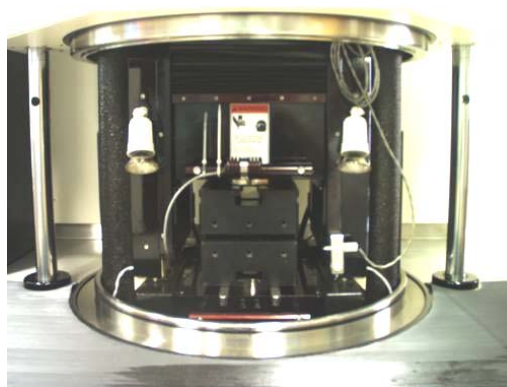

Figure 6. Shear Box in SST

Currently in the UK, the method to assess bond strength is an in-situ torque test. In this test, the pavement is cored below the interface of interest and left in place (3). A plate is bonded to the surface of the core, then a torque wrench is attached to the plate and a torque is applied manually until failure occurs. Four inch (100 mm) diameter cores are used to limit the magnitude of the moment to break the bond. At the University of Nottingham, Collep et. al. have also conducted research for the UK Highways Agency on the bond between asphalt layers (15). Their work has focused on developing a laboratory test that is able to test layer bonding in more controlled conditions. They have adapted the Leutner test which is the standard in Austria. Tests are performed at 68°F (20°C) with a loading rate of two inches per minute (50 mm/min).

In 2003, Sholar et al. (16) at the Florida Department of Transportation (FDOT) developed a simple direct shear device that can be used in a universal testing machine or a Marshall press. Initially, they evaluated an emulsion tack coat material by bonding two metal cylinders (Figure 7). They evaluated the effect of temperature and loading rate and settled on using a temperature of 77°F (25°C) with a loading rate of 2 inches/min. (50.8 mm/min.). Later, field test sections were constructed on three projects: one project with fine-graded mixtures, one project with coarse-graded mixtures, and the final project having a coarse-graded mixture place on a milled

surface. Test sections were made with three application rates and with no tack. Water was also sprayed on two tacked sections to simulate rain. Their results indicate that water significantly reduced the bond of the sections. All sections gained bond strength with time. The effect of application rates within the range of 0.02 to 0.08 gal/yd² (0.091 to 0.362 L/m²) was not consistent for the three projects. The Florida DOT now uses this method to evaluate pavement layer bonding on projects whenever there is a question about the integrity of the bond due to rain during paving operations.

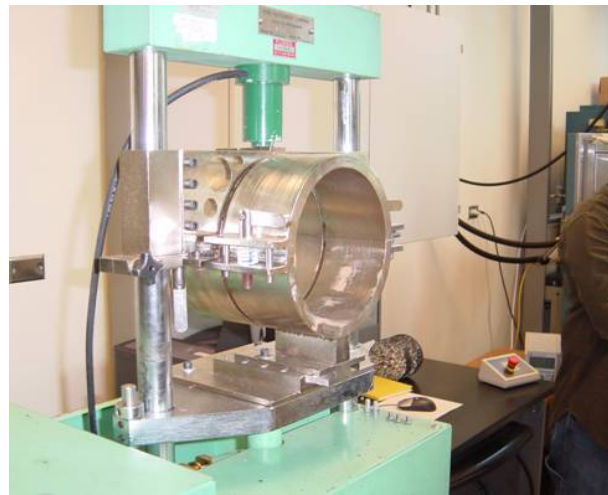

Figure 7. FDOT Bond Strength Device

In Italy, Santagata, Canestari, and others have used a device known as the Ancona Shear Testing Research and Analysis (ASTRA) apparatus (Figure 8) to study effects of temperature and surface as well as the fundamental shear behavior of bonded interfaces of multilayered pavements (17,18,19). Several improvements have been made to the device over the past ten years. The ASTRA device applies a normal load to the sample during shear with a shear displacement rate of 0.1 in/min (2.5 mm/min).

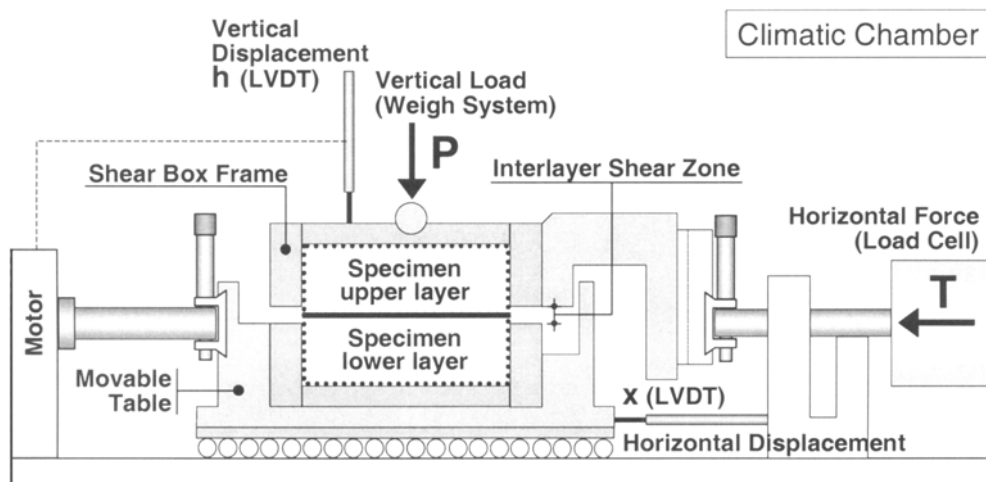

Figure 8. ASTRA Shear Box Apparatus for Evaluating Bond Strength

Another test that has recently been used for testing the bond strength of tack coats is the ATACKER™ device (Figure 9) by Instrotek, Inc (20). Tack coat material is applied to a metal plate, an HMA sample, or a pavement surface and a metal disc is brought down to make contact with the tacked surface. The bond strength between the surfaces can be measured in tensile mode or in torsion.



Figure 9. ATACKER™ Device for Tack Coat Bond Strength

Several important studies on tack coat bonding are also just underway. A National Cooperative Highway Research Program (NCHRP) study was initiated in 2005 to determine optimum application methods, equipment types and calibration procedures, and asphalt binder materials for various uses of tack coats. This is NCHRP Project 9-40 and the research agency is the Louisiana Transportation Research Center. It is scheduled for completion in January 2008.

A worldwide interlaboratory study on interlayer bonding was also initiated by the Réunion Internationale des Laboratoires d'Essais et de Recherches sur les Matériaux et les Constructions (RILEM) Technical Committee ATB, Advanced Testing and Characterization of Bituminous Materials TG-4 – Pavement Performance Prediction and Evaluation. This study will enable comparison of different methods for measuring bond strength. Another study is planned by the Washington Department of Transportation and Washington State University. This project will involve the construction of test sections with two asphalt emulsion tack coats at two application rates for a milled and unmilled HMA surface. Other factors being evaluated are surface cleanliness and cure time. A variety of tests are planned to evaluate the effectiveness of the tack coat.

Summary of Bond Strength Test Methods

A summary of bond strength test methods is provided in Table 1.

TABLE 1. Current Bond Strength Devices Being Evaluated

Shear Strength Tests	Tensile Strength Tests	Torsion Strength Test
ASTRA (Italy) FDOT method (Florida) LPDS method (Swiss) Japan method Superpave Shear Tester (LTRC)	ATACKER Austrian method MTQ method (Quebec)	ATACKER United Kingdom

EXPERIMENTAL PLAN

The first phase of this study was to refine the NCAT bond strength device and establish a standard procedure for conducting the test. As part of this work, it was desired to evaluate the effects of several material variables and test conditions on bond strength. The material variables of interest included mixture texture, tack coat material type, and tack coat application rate. The test condition factors evaluated were normal pressures applied to the specimen during the bond strength test and test temperature. These factors and their levels are summarized in Table 2.

TABLE 2. Experimental Factors Used in the Laboratory Phase

Factors	Levels
Mix Type	19.0 mm NMAS coarse graded, 4.75 mm NMAS fine graded
Tack Material	CRS-2, CSS-1, PG 64-22
Application Rate	0.02, 0.05, 0.08 gal/yd ² (based on residual asphalt)
Normal Pressure	0, 10, 20 psi (0, 69, and 138 kPa)
Temperature	50, 77, 140°F (10, 25, 60°C)

Materials

Two mixtures were used to evaluate the possible effect of surface texture on bond strength. A coarse-graded 19 mm nominal maximum aggregate size (NMAS) mixture was selected to provide a rough textured surface and a fine-graded 4.75 mm NMAS mixture was selected to provide a smooth textured surface. It was expected that the different surface textures of the two mixes would create different frictional values at the interface between two layers. Superpave volumetric mix designs were conducted for both coarse-graded and fine-graded mixtures.

The tack coat materials evaluated included two types of emulsion (CRS-2 and CSS-1) and one performance-graded asphalt binder (PG 64-22). Each of these tack coat materials is allowed within Section 405 of the Alabama DOT's 2001 Specifications. The tack coat materials used were characterized by measuring the rheological properties at different temperatures. Table 3 shows the measured rheological properties of the tack coat materials.

TABLE 3. Rheological Properties of the Emulsion Residues and PG 64-22

Tack Coat Type	Residue %	$G^*/\sin\delta$ (kPa) 60°C	$G^*\cdot\sin\delta$ (kPa) 25°C	$G^*\cdot\sin\delta$ (kPa) 10°C	Viscosity Pa·S 135°C
CRS-2	71.5	1.760	203	2171	0.325
CSS-1	69.1	4.688	1576	16869	0.546
PG 64-22	100	7.830	4712	31758	0.537

Three application rates were investigated for each tack coat. For the two emulsions (CRS-2 and CSS-1), three application rates were used: 0.04, 0.08, and 0.12 gal/yd² (0.18, 0.36, and 0.54 L/m²) based on residual asphalt. These application rates provide an evaluation of the application rate range specified by ALDOT. For the straight asphalt cement (PG 64-22), application rates of 0.02, 0.05, and 0.08 gal/yd² (0.09, 0.23, and 0.36 L/m²) were evaluated, which encompassed the range specified by ALDOT.

Laboratory Specimen Preparation

Normal Superpave mix design sized samples (115 mm height by 150 mm diameter) were fabricated at optimum asphalt content. The SGC samples were cut into two halves and volumetric properties of each half were measured.

Tack coat materials were evenly applied to the uncut side of each half using a wooden spatula at each of the desired application rates. The SGC half specimen with tack coat was then put into a gyratory mold (tack surfacing upward) and loose mix of the same mix type was placed on top of the tack surface and compacted to 50 gyrations. This compactive effort was selected to provide a density of the upper layer that would be representative of the first few years of the pavement life and to avoid over compacting the mix which may have resulted in excessive breakdown or disturbing the tacked interface. Replicate specimens for each combination were prepared and tested. A total of 324 specimens were prepared and tested in the first phase of this project.

Bond Strength Tests

The NCAT bond strength device used in this study is similar to what several other researchers have used. It is a shear type test and loading can be performed with a universal testing machine or a Marshall press. A few modifications were made to the original version of NCAT's bond strength testing device. Figure 10 shows an illustration the bond strength device. The main improvement from the original version was the added capability of applying horizontal load (perpendicular to the direction of shear) as a normal pressure to the test samples. A research hypothesis was that the normal pressure would be necessary to identify the benefit of friction due to surface texture and may therefore provide a greater difference between good and bad performing bonds. Three normal stress levels were investigated: 0, 10, and 20 psi (0, 69, and 138 kPa).

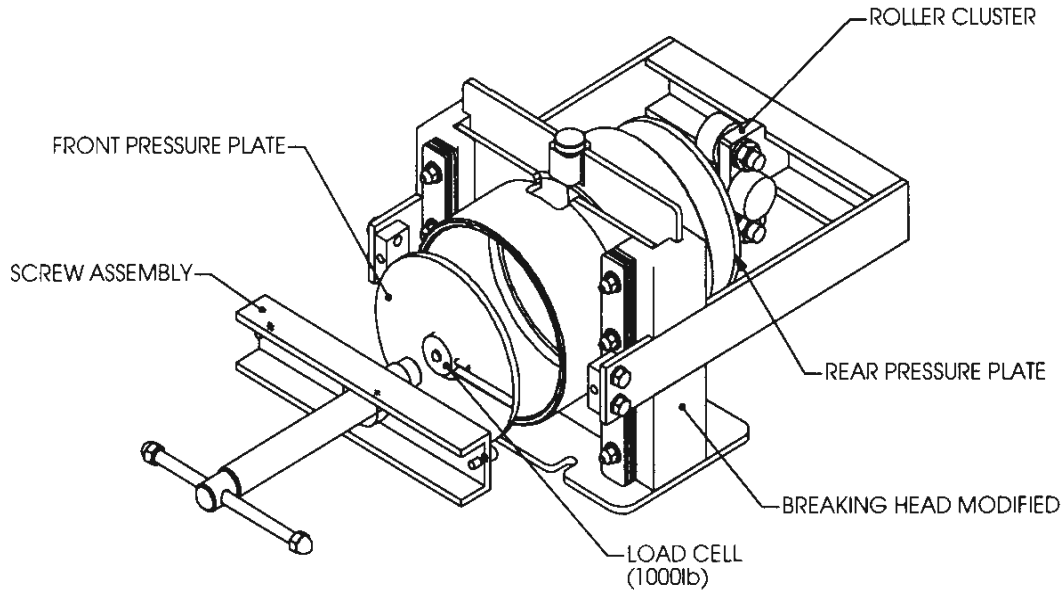

Figure 10. Illustration of NCAT Bond Strength Device

A closed-loop servo-hydraulic MTS machine was used in the lab phase of the study using the loading rate of two inches per minute (50.8 mm/min.). Using the MTS enabled collection of load and deformation data in a digital format which is easier to analyze. The MTS environmental chamber was used to maintain temperature during the test.

Three test temperatures were studied: 50, 77, and 140°F (10°C, 25°C, and 60°C). The high temperature, 140°F, was considered a critical test temperature for slippage. The 50°F temperature was selected because of possible delamination at low temperatures. The 77°F temperature was selected as an intermediate temperature. Specimens were allowed to stabilize at the test temperature for four hours prior to testing.

TEST RESULTS AND DISCUSSION

Figure 11 presents a typical shear deformation versus shear load plots for duplicate samples. Bond strength, S_B , was calculated based on the maximum load as follows:

$$S_B = P_{MAX} / A$$

where:

- S_B = bond strength, psi
- P_{MAX} = maximum load applied to specimen, lbf
- A = cross-sectional area of test specimen, in²

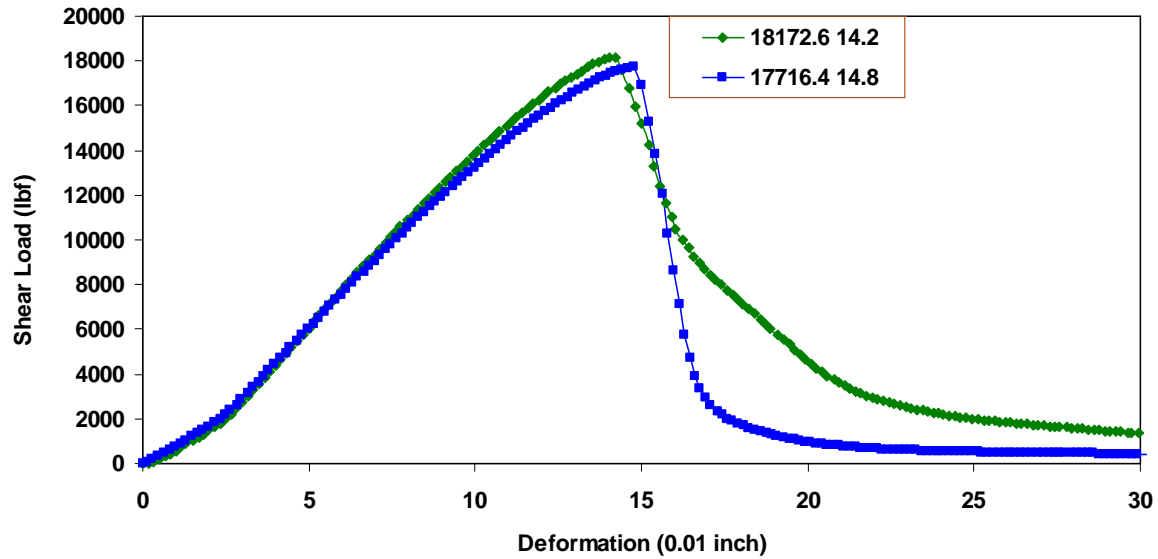

Figure 11. Typical Load - Deformation Plot from a Bond Strength Test

For each combination of mix type, tack coat type, application rate, normal pressure, and test temperature, two specimens were tested and the average of these two test results were reported. Table 4 presents the average bond strengths for the 19.0 mm coarse-graded mixture. Table 5 summarizes the average bond strengths for the 4.75 mm fine-graded mixture. The results presented in these tables are the average of two test specimens.

TABLE 4. Bond Strength Results of 19.0 mm Coarse-Graded Mixture

Tack Coat Type	Normal Pressure	Application Rate, gal/yd ²	Average Bond Shear Strength (psi)		
			50°F	77°F	140°F
CRS-2	0 psi	0.04	560.8	259.9	25.6
		0.08	514.3	216.9	29.5
		0.12	471.3	246.1	30.7
	10 psi	0.04	545.3	246.8	51.3
		0.08	620.4	240.1	50.1
		0.12	588.4	210.3	56.0
	20 psi	0.04	535.7	293.7	53.9
		0.08	505.4	285.2	48.2
		0.12	554.2	251.0	55.0
CSS-1	0 psi	0.04	654.4	211.0	30.3
		0.08	574.0	219.1	25.5
		0.12	587.9	199.6	26.4
	10 psi	0.04	600.0	384.5	51.8
		0.08	635.5	371.4	51.4
		0.12	586.8	359.5	47.6
	20 psi	0.04	563.4	316.2	56.8
		0.08	625.8	294.7	57.7
		0.12	630.4	319.6	53.3
PG 64-22	0 psi	0.02	571.1	355.8	30.5
		0.05	653.2	329.5	31.7
		0.08	614.1	298.0	33.0
	10 psi	0.02	667.2	309.9	51.0
		0.05	658.0	306.3	53.6
		0.08	661.3	274.7	54.2
	20 psi	0.02	618.3	319.2	57.8
		0.05	634.5	311.0	57.3
		0.08	625.8	320.3	50.4

TABLE 5. Bond Strength Results of 4.75 mm Fine-graded Mixture

Tack Coat Type	Normal Pressure	Application Rate (gal/yd ²)	Average Bond Shear Strength (psi)		
			50°F	77°F	140°F
CRS-2	0 psi	0.04	679.5	310.1	35.0
		0.08	660.8	269.7	30.7
		0.12	568.8	247.9	30.7
	10 psi	0.04	723.5	322.5	47.2
		0.08	680.8	325.9	37.2
		0.12	566.0	268.5	36.0
	20 psi	0.04	617.2	309.3	62.1
		0.08	572.9	300.5	53.4
		0.12	577.8	252.7	46.0
CSS-1	0 psi	0.04	735.1	263.6	34.3
		0.08	562.8	243.4	28.9
		0.12	665.9	220.9	27.1
	10 psi	0.04	696.5	447.5	51.8
		0.08	696.1	420.3	44.4
		0.12	712.3	371.4	35.1
	20 psi	0.04	623.4	372.6	62.6
		0.08	629.3	385.1	55.0
		0.12	631.8	349.7	45.5
PG 64-22	0 psi	0.02	735.3	407.2	64.6
		0.05	719.0	425.7	47.8
		0.08	655.1	369.6	38.0
	10 psi	0.02	737.8	455.1	59.0
		0.05	729.7	434.7	50.4
		0.08	737.5	412.8	42.4
	20 psi	0.02	716.9	415.1	84.3
		0.05	719.8	379.7	69.9
		0.08	726.9	364.6	57.3

The effects of mixture types, asphalt tack coat types, application rates, normal pressures, and test temperatures on bond shear strength were analyzed using the data reported in Tables 4 and 5. Analysis of the bond strength data consisted of conducting an analysis of variance (ANOVA). Because there were two replicate observations, a measure of experimental error was available evaluating the significance of the factors. The three application rates for each tack coat were identified as low, medium and high for the analysis.

Table 6 presents the results of the ANOVA conducted on the bond strength data. Based on this analysis, the five main factors were significant (mix type, tack coat type, temperature, tack coat application rate, and normal pressure) as well as a number of two-way interactions and one three-way interaction. This indicates that all of these factors influence the bond strength between two HMA layers. Based on the F-statistics, for the five main factors, temperature was the most

significant factor followed by mixture type, tack coat type, normal pressure, and application rate, respectively.

TABLE 6. Results of ANOVA for Bond Shear Strength

Source	DF	Seq SS	Adj SS	Adj MS	F	P	Significant at 95%
Mix	1	166523	166523	166523	154.66	0.000	Yes
Tack Type	2	217317	217317	108658	100.92	0.000	Yes
Rate	2	28102	28102	14051	13.05	0.000	Yes
Temperature	2	18574660	18574660	9287330	8625.95	0.000	Yes
Normal Pressure	2	74217	74217	37108	34.47	0.000	Yes
Mix*Tack Type	2	13836	13836	6918	6.43	0.002	Yes
Mix*Rate	2	11820	11820	5910	5.49	0.005	Yes
Mix*Temperature	2	79149	79149	39574	36.76	0.000	Yes
Mix*Normal Pressure	2	3459	3459	1729	1.61	0.204	No
Tack Type*Rate	4	5611	5611	1403	1.30	0.271	No
Tack Type*Temperature	4	82087	82087	20522	19.06	0.000	Yes
Tack Type*Normal Pressure	4	30295	30295	7574	7.03	0.000	Yes
Rate*Temperature	4	7877	7877	1969	1.83	0.126	No
Rate*Normal Pressure	4	8341	8341	2085	1.94	0.107	No
Temperature*Normal Pressure	4	39150	39150	9787	9.09	0.000	Yes
Mix*Tack Type*Rate	4	3353	3353	838	0.78	0.540	No
Mix*Tack Type*Temperature	4	8364	8364	2091	1.94	0.106	No
Mix*Tack Type*Normal Pressure	4	2743	2743	686	0.64	0.637	No
Mix*Rate*Temperature	4	5847	5847	1462	1.36	0.251	No
Mix*Rate*Normal Pressure	4	345	345	86	0.08	0.988	No
Mix*Temperature* Normal Pressure	4	10062	10062	2515	2.34	0.058	No
Tack Type*Rate*Temperature	8	10454	10454	1307	1.21	0.293	No
Tack Type*Rate*Normal Pressure	8	11300	11300	1413	1.31	0.241	No
Tack Type*Temp*Normal Pressure	8	86825	86825	10853	10.08	0.000	Yes
Rate*Temperature*Normal Pressure	8	13400	13400	1675	1.56	0.142	No
Mix*Tack Type*Rate*Temperature	8	7273	7273	909	0.84	0.565	No
Mix*Tack Type*Rate* Normal Pressure	8	5676	5676	710	0.66	0.727	No
Mix*Tack Type*Temperature*	8	16234	16234	2029	1.88	0.065	No
Normal Pressure							
Mix*Rate*Temp* Normal Pressure	8	604	604	75	0.07	1.000	No
Tack Type*Rate*Temperature*	16	26715	26715	1670	1.55	0.088	No
Normal Pressure							
Mix*Tack Type*Rate*	16	16688	16688	1043	0.97	0.493	No
Temperature*Normal Pressure							
Error	162	174421	174421	1077			
Total	323	19742749					

Figure 12 shows the average bond strength for each test temperature and normal pressure combination. As can be seen, when temperature increases, the bond strength decreases dramatically. On average, bond strengths were 2.3 times greater at 50°F (10°C) compared to 77°F (25°C); and the bond strengths at 140°F (60°C) were about one sixth of the bond strength at 77°F. This was expected since the tack coat materials are much stiffer at the lower temperature. For a few tests at 50°F, the bond strengths exceeded the limit of the MTS loading capacity. In these cases, the shear bond strengths are actually higher than the values reported. Due to this occasional over-limit situation and the fact that temperature had a dominant effect on shear bond strength, it was believed that analyzing the data separately was necessary to evaluate the impact of other factors on bond strength. Bond strengths at 77 and 140°F were therefore analyzed separately later in the report.

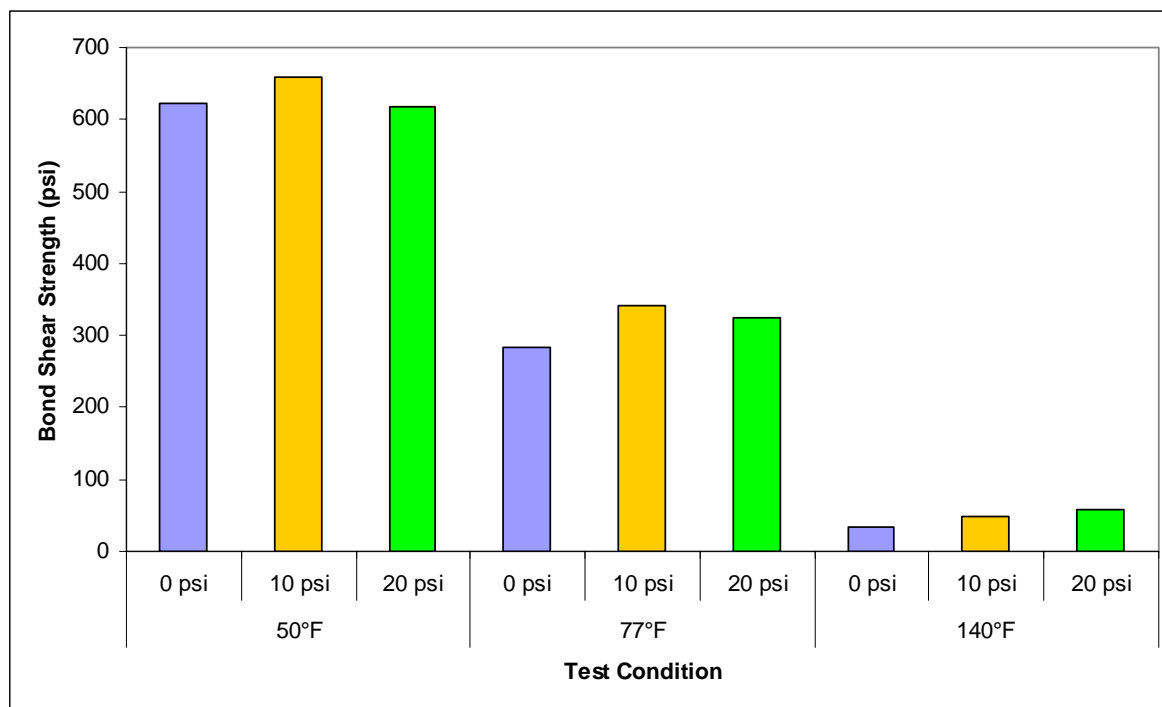

Figure 12. Effect of Temperature and Normal Load on Bond Strength

The effect of normal pressure on bond strength was different at each temperature, as shown in Figure 12. At 140°F, on average, bond strength increases when the normal pressure increases from 0 to 10 and 20 psi. At 77°F and 50°F, bond strength increases when normal pressure is applied. However, at the moderate to low temperatures, the bond strength does not change much when normal pressure increases from 10 to 20 psi. This is a logical finding since at the higher temperatures, friction at the interface dominates bond strength and frictional resistance is proportional to the normal force.

Separate ANOVAs were conducted on the bond strength results at 77 and 140°F. Tables 7 and 8 summarize the ANOVA results for 140°F and 77°F respectively.

TABLE 7. Results of ANOVA for Bond Shear Strength at 140°F

Source	DF	Seq SS	Adj SS	Adj MS	F	P	Significant at 95%
Mix	1	116.8	116.8	116.8	5.93	0.018	Yes
Tack Type	2	1693.1	1693.1	846.6	43.01	0.000	Yes
Rate	2	1185.1	1185.1	592.6	30.10	0.000	Yes
Normal Pressure	2	10336.0	10336.0	5168.0	262.55	0.000	Yes
Mix*Tack Type	2	956.0	956.0	478.0	24.28	0.000	Yes
Mix*Rate	2	1099.3	1099.3	549.7	27.92	0.000	Yes
Mix*Normal Pressure	2	1173.3	1173.3	586.7	29.80	0.000	Yes
Tack Type*Rate	4	265.5	265.5	66.4	3.37	0.016	Yes
Tack Type*Normal Pressure	4	199.4	199.4	49.9	2.53	0.051	No
Rate*Normal Pressure	4	128.1	128.1	32.0	1.63	0.181	No
Mix*Tack Type*Rate	4	142.9	142.9	35.7	1.82	0.139	No
Mix*Tack Type*Normal Pressure	4	155.6	155.6	38.9	1.98	0.111	No
Mix*Rate*Normal Pressure	4	10.7	10.7	2.7	0.14	0.969	No
Tack Type*Rate*Normal Pressure	8	135.2	135.2	16.9	0.86	0.557	No
Mix*Tack Type*Rate*Normal Press.	8	104.2	104.2	13.0	0.66	0.722	No
Error	54	1062.9	1062.9	19.7			
Total	107	18764.2					

At 140°F, all the main factors (mix type, tack coat type, application rate, and normal pressure) are significant. Some two-way interactions are also significant. At this temperature, normal pressure has the greatest effect on bond strength.

Figures 13 and 14 illustrate the bond strengths of the fine and coarse-graded mixtures, respectively, at 140°F for the three tack materials at each application rate and each normal pressure. Here it can be seen that as normal pressure increases, there is a general increase in bond strength. The normal pressure effect is more evident at the higher test temperature because the binder stiffness is reduced and the friction effect between layers becomes a greater factor. With no normal load, the bond strength results for the fine and coarse-graded mixtures with the CRS-2 and CSS-1 are in a similar range. When the 10 psi normal load is applied, the bond strength for the fine-graded mixture samples increases by 24%, but the coarse-graded samples increased by 78%. This more dramatic increase for the coarse-graded mixtures due to normal pressure is most likely due to the influence of interface friction between the higher textured surface of the coarse mix. Although differences in texture of the two mixtures was not quantified, it is reasonable to assume that the larger aggregate size and coarse gradation of the 19.0 mm mixture created more mechanical interlock between aggregate particles at the interface. Since friction is a coefficient that relates the sliding force and normal force, the observation that higher bond strengths were measured when a normal force was applied is also logical.

For the fine-graded mixture, the PG 64-22 provides higher bond strengths compared to the CRS-2 and the CSS-1. There was no apparent difference among the three tack coat materials for the coarse-graded mixture. In the case of the coarse graded mixture, the surface texture may be dominating the bond strength.

Another interesting trend that is apparent for the fine-graded mixture is the effect of application rate. For each tack coat material and each normal load, the bond strengths decrease as the tack application rate increases. Such a trend is not evident for the coarse-graded samples. This data indicates that low application rates may be better than high application rates for fine graded mixes. However, this observation should be reviewed for field conditions where pavement surfaces may be old, worn, and dirty.

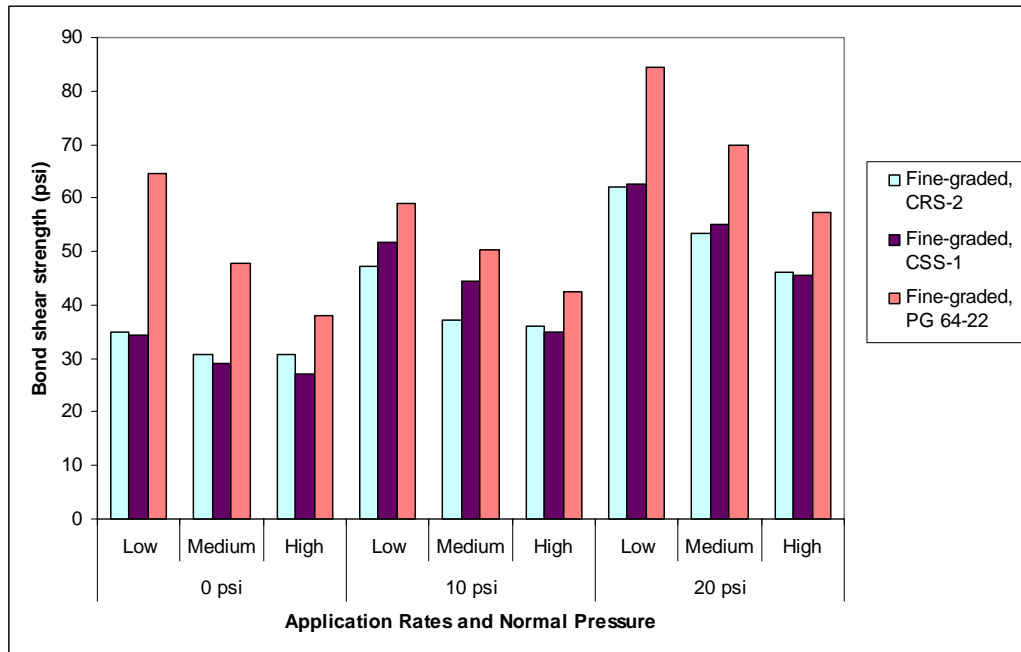

Figure 13. Bond Shear Strength for Fine-Graded Mixture at 140°F

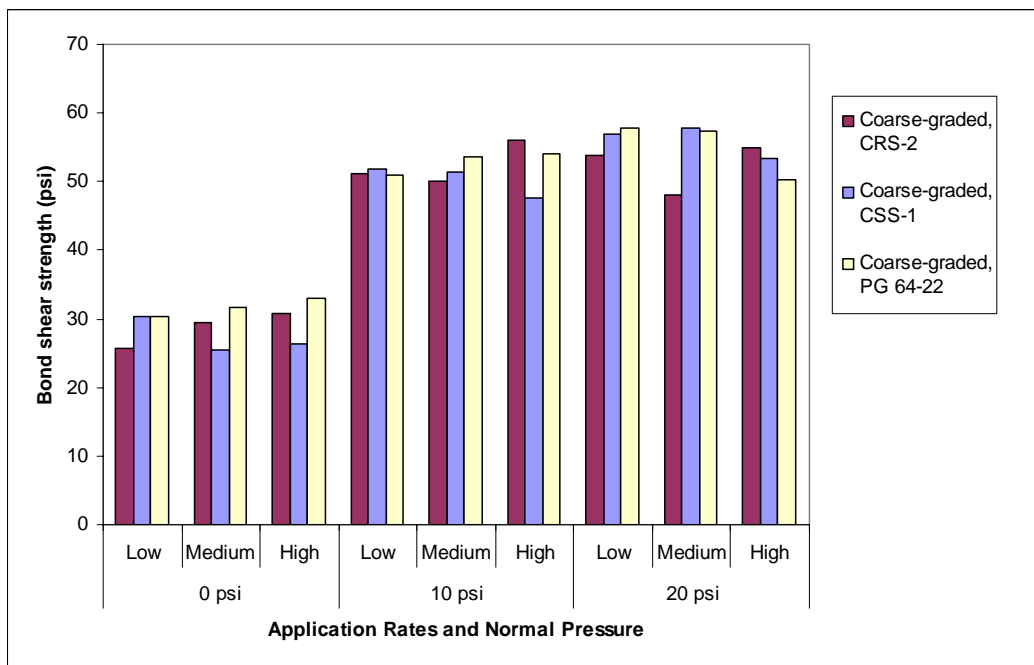

Figure 14. Bond Shear Strength for Coarse-Graded Mixture at 140°F

Similar analyses were conducted on the bond strength results at 77°F. The ANOVA shown in Table 8 indicates that all main factors and some two-way interactions have significant effects on bond strength at 77°F. Figures 15 and 16 show the bond strength for the fine- and coarse-graded mixtures, respectively, at 77°F for the three tack coat materials at each application rate and each normal pressure.

Table 8. Results of ANOVA for Bond Shear Strength at 77°F

Source	DF	Seq SS	Adj SS	Adj MS	F	P	Significant t at 95%
Mix	1	94360	94360	94360	176.55	0.000	Yes
Tack Type	2	148417	148417	74208	138.85	0.000	Yes
Rate	2	25010	25010	12505	23.40	0.000	Yes
Normal Pressure	2	66746	66746	33373	62.44	0.000	Yes
Mix*Tack Type	2	15893	15893	7947	14.87	0.000	Yes
Mix*Rate	2	3903	3903	1952	3.65	0.033	Yes
Mix*Normal Pressure	2	8318	8318	4159	7.78	0.001	Yes
Tack Type*Rate	4	702	702	176	0.33	0.858	No
Tack Type*Normal Pressure	4	111071	111071	27768	51.96	0.000	Yes
Rate*Normal Pressure	4	1302	1302	326	0.61	0.658	No
Mix*Tack Type*Rate	4	546	546	136	0.26	0.905	No
Mix*Tack Type*Normal Pressure	4	7407	7407	1852	3.46	0.014	Yes
Mix*Rate*Normal Pressure	4	255	255	64	0.12	0.975	No
Tack Type*Rate*Normal Pressure	8	5329	5329	666	1.25	0.291	No
Mix*Tack Type*Rate*Normal Pressure	8	3767	3767	471	0.88	0.538	No
Error	54	28861	28861	535			
Total	107	521888					

The ANOVA and Figures 15 and 16 show that the coarse and fine-graded mixes have different bond strengths. Generally, the fine-graded mixture provided higher bond strengths than the coarse-graded mixture when tested at 77°F. On average, the bond strength for the fine-graded mixture was 346.1 psi. The average bond strength for the coarse mixture was 287.0 psi. Although, it may be expected that the coarse-graded mixture would provide more friction to shear at the interface, the bond strength results at this temperature do not support that hypothesis. A possible explanation is that the fine textured mixtures have a greater area of contact making the tack coat application more effective.

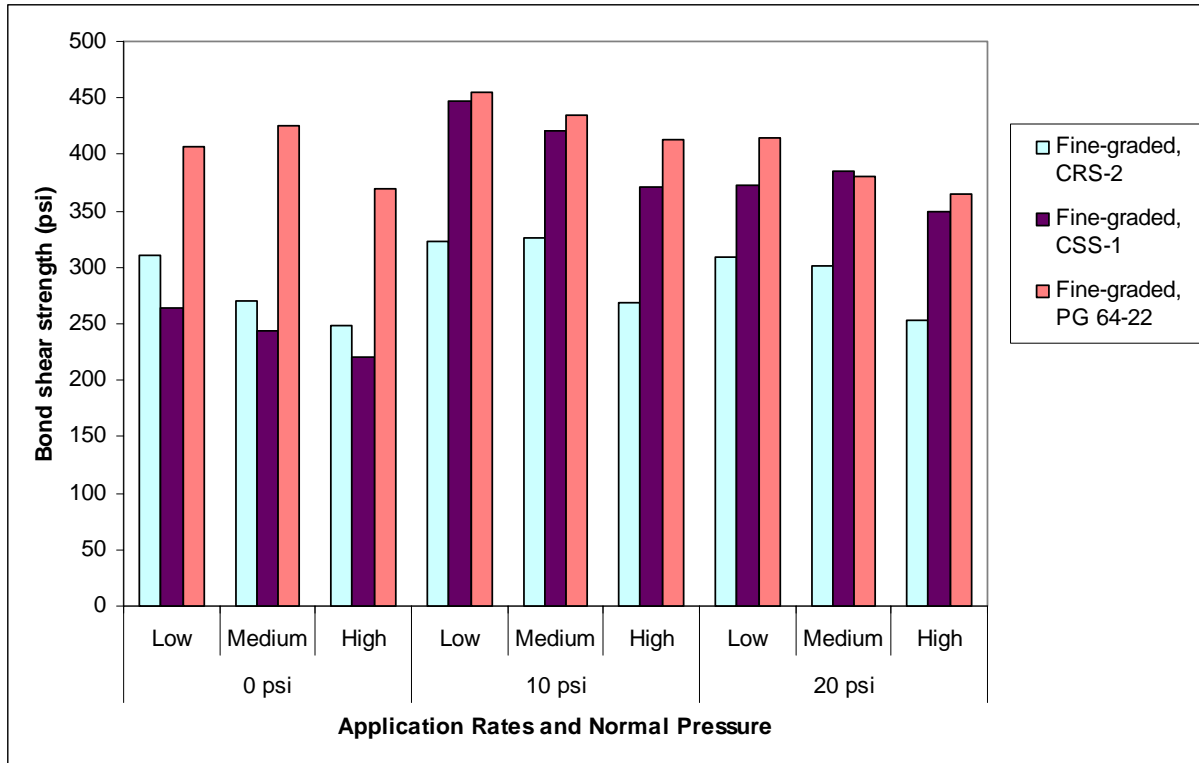

Figure 15. Bond Shear Strength for Fine-Graded Mixtures at 77°F

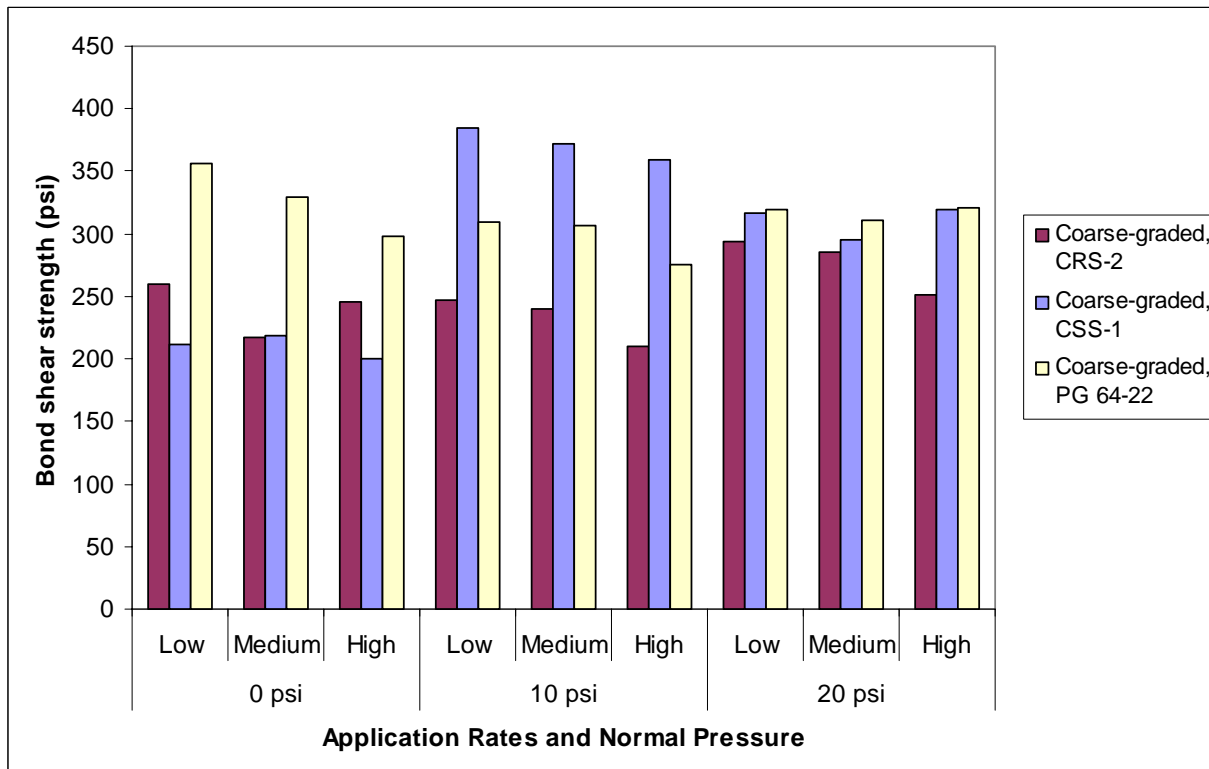

Figure 16. Bond Shear Strengths of Coarse-Graded Mixture at 77°F

Tack coat type also had significant effect on bond strength. Similar to the results shown at 140°F, it appears that the PG 64-22 provides higher bond strength than the two emulsions.

As discussed earlier, bond strengths at 77°F were insensitive to normal pressure applied in the test. On average, when normal pressure is applied, there is a slight increase in bond strength. However, for some specimens, bond strength tested at 10 psi was higher than the bond strength tested at a normal pressure of 20 psi.

Application rates also influence the bond strength at 77°F. In general, low application rates provided higher bond strengths. In some cases, however, the bond strength was not sensitive to the application rate. Similar to the finding for tests at 140°F, at 77°F the fine-graded mix with PG 64-22 as tack coat had the highest bond strength.

Summary of Phase I Findings

In the laboratory experimental plan, the bond strength between two HMA layers was evaluated using a bond strength device at 50, 77 and 140°F with three normal pressure levels (0, 10, and 20 psi) for each temperature. Tack coat materials selected for evaluation included two types of emulsions and one type of PG asphalt binder that are allowed within ALDOT's specification. Three application rates that encompassed the ALDOT specification range were investigated for each tack coat. Mixes selected represented two gradations with different surface textures. The following findings were drawn from the laboratory phase:

1. All the factors included in the test plan had a significant effect on bond strength. Testing temperature had the most significant impact on bond strength. As the temperature increases, bond strength decreases significantly for all tack coat types, application rates, mixtures, and for bond strength tested at all normal pressure levels. It is not practical to test bond strength at low temperatures since the maximum shear load can exceed the capacity of the testing machine. Bond strength tests conducted at both intermediate and high temperatures are able to evaluate the difference among tack coat materials, application rates, and mixtures. Tests at the intermediate temperature provide a greater range of bond strengths than the tests at the high temperature.
2. Normal pressure affected bond strength differently for high, intermediate, and low temperatures. At high temperature, when normal pressure increases, the bond strength increases. At intermediate and low temperatures, bond strength was not very sensitive to the normal pressure levels.
3. From this phase of the study, it appears that the PG asphalt binder provides a higher bond strength than the two emulsions (CRS-2 and CSS-1), especially for the fine-graded mixture tested at high temperature. The difference between CRS-2 and CSS-1 is minor.
4. For the range studied, low application rates generally provided higher bond strengths for the fine-graded mixture. However, for the coarse-graded mixture, bond strengths do not change much when application rate varies.
5. The two mixture types provided different bond strength. The influences of tack coat type and application rate on bond strength are different for the fine-graded and coarse-graded mixtures.

Development of Preliminary Bond Strength Procedure

Based upon the results from Phase I, and considering practical application of the bond strength test, NCAT selected the test conditions as 77°F (25°C) with no normal pressure.

It was shown that bond tests at higher temperatures also have merit since this is a more critical condition for which slippage is more likely to occur. At 140°F (60°C), the use of a normal pressure appears to better show the influence of friction at the interface. However, at 140°F bond strengths are low and with testing variability it would be more difficult to establish a criteria to discern between acceptable and unacceptable results. On average, the bond strengths at 140°F are typically less than 20% of the bond strength at 77°F.

The simplified conditions of testing at room temperature without a normal load also allow for the test to be performed in any typical asphalt lab equipped with a Marshall press. The only additional equipment needed to perform the test is the bond strength device which can be purchased for approximately \$7500. The time to prepare a sample and conduct the test is just a few minutes. This very practical test set up is believed to provide a good indication of whether or not sufficient bond has been achieved in the field and provide enough sensitivity to rate different materials, application rates, and surface types. The draft procedure for the NCAT Bond Test is provided in Appendix B.

Phase II: Field Validation of the Bond Strength Test

A field study was planned to validate the bond strength procedure developed in Phase I. The original plan was to validate the test using four HMA construction projects, each project having a different underlying surface for evaluation of different surface textures on bond strength. It was proposed to construct test sections with two different types of tack coat material on each project. However, finding paving contractors with two tack distributors on any project proved unworkable. Most contractors in Alabama use emulsion tack coats and very few use paving grade asphalt for tack coats. None were equipped to provide both types. Therefore, the decision was made to try to set up the test sections on different paving projects.

Three tack coat test sections with different application rates were constructed for each project. Figure 17, shows an illustration of the test sections. The three sections were set up to target a low, a medium, and a high application rate within the ALDOT specification range. For projects using an emulsified asphalt tack coat material, the target application rates were 0.05, 0.075, and 0.10 gal/yd² (0.25, 0.38, and 0.5 L/m²) based on total emulsion. Assuming a 60% residual asphalt content for the emulsions, the target application rates based on residue were 0.03, 0.045, and 0.06 gal/yd² (0.15, 0.23, and 0.30 L/m²). For projects using a paving grade binder as the tack coat material, the target application rates were 0.03, 0.05, and 0.07 gal/yd² (0.15, 0.25, and 0.35 L/m²). After the tack coat sections were set up, normal pavement construction practices were followed which included HMA haul trucks backing over the tacked surfaces. After the HMA overlay was placed and compacted, three to five cores were obtained from each section and returned to the NCAT laboratory for bond strength testing using the draft procedure.

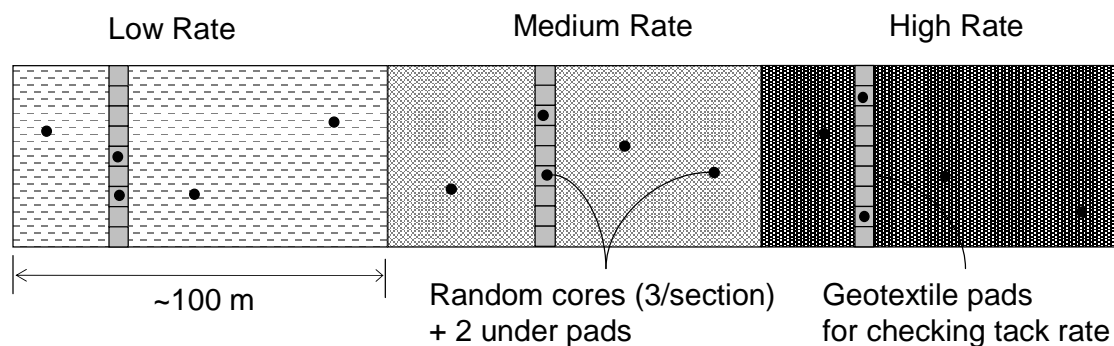

Figure 17. Illustration of Layout for Field Test Sections

The first project for the tack coat and bond strength test sections was on State Road 21 south of Talladega, Alabama. The tack coat was a CSS-1 emulsion. Test sections were set up on August 8, 2004. A heavy butcher paper was used to check the actual application rates on this project. One square yard of paper was taped on the corners to the roadway before the distributor truck applied the tack. After the tack was applied to the sections, the butcher paper was removed and weighed to determine the application rate. Using this technique, the paper is dried to a constant mass before weighing, so the application rate calculated is based on residual asphalt. Table 9 shows the results of the measurements for the tack coat test sections. This data shows that the actual rate was much less than the target application rate.

Table 9. Tack Coat Application Rates and Bond Strengths for Project 1

Section	Target Rate Total Emulsion (gal/yd ²)	Target Rate for Residual Asphalt (gal/yd ²)	Measured Rate Residual Asphalt (gal/yd ²)	Average Bond Strength (psi)
Low	0.05	0.03	0.004	0
Med.	0.075	0.05	0.006	0
High	0.01	0.07	0.007	37.1

Attempts to obtain cores were unsuccessful the day the sections were set up. The cores debonded at the interface between the overlay and the underlying surface. Since this was the first project, it was thought that this problem may be due to the very high ambient temperatures. So a second attempt was made to cut cores the following morning. No traffic was allowed on the sections overnight. Still, only cores from the third section could be obtained. The average bond strength for these cores, also shown in Table 9, was also very low (37.1 psi). The calculations for the tack application rates were completed later. These very low rates explain the difficulty in getting good cores and the low bond strength for the last section. It is also interesting to note that the contractor had difficulty meeting the required density on the new mat. On a number of the cores, hairline cracks were evident (Figure 18), often called check cracking. Although this type of cracking is often associated with tender mixes, it can also be caused by the lack of a bond between the new mat and the underlying surface.



Figure 18. Core from Project 1 Showing Hairline Cracks in Surface Layer (left)

For the remaining field projects, the actual tack coat application rates for the test sections were determined using ASTM D 2995, *Standard Practice for Estimating Application Rate of Bituminous Distributors* (23). NCAT found this to be an effective method. This method is easy to use and applicable to any type of tack material. It can be used to determine transverse and longitudinal uniformity of the tack application rate. This method consists of placing pre-weighed pads of non-woven geotextile fabric across the lane for transverse measurements (Figures 19 and 20), or in the direction the tack truck travels for longitudinal measurements, and then allowing the tack truck to apply the tack coat over the area using the truck's normal application procedure. The pads are then removed and re-weighed. The tack applied to each pad is used to calculate the application rate for the pad area.

Figure 21 shows a photograph from one of the tack coat test sections. The stripe across the milled surface is where the pads were removed to measure the actual application rate. On most projects, cores were taken at these locations to determine the bond strength between the pavement layers with no tack. In actuality, some tack coat was likely tracked on to this stripe by the construction equipment.



Figure 19. ASTM D 2995 Pads Used to Evaluate Transverse Application Uniformity



Figure 20. Placing Pads for ASTM D 2995



Figure 21. Photograph Showing Location Where Geotextile Pads Were Used to Measure Actual Tack Coat Application Rate

The second field project was located near Lafayette, Alabama in Chambers County on County Road 32 (Figure 22). The tack coat test sections were set up on September 16, 2004. The contractor used a PG 64-22 binder as the tack coat. The tack coat sections were applied over an HMA leveling course that had been placed a few days prior. The tack coat was applied using a distributor spray bar. The measured application rates are shown in the Table 10. The distributor truck operator did not adjust the application rate after the first section, so a second “low” section was constructed.



Figure 22. Application of PG 64-22 Tack Coat Test Section on Project 2

The application rates measured with ASTM D 2995 for this project are reasonably close to the target rates for each section. Cores were obtained from the tack coat sections the following day. Traffic had been allowed on the test sections. However, this is a low volume road and traffic was most likely not heavy in the area where the cores were cut. The weather was warm the day the hot mix was placed and the next day when the cores were cut.

Bond strengths for the cores from project 2 are shown in Table 11. The average bond strength for the first “low” section was significantly lower than for the second “low” section. The low bond strength for core number 1 skewed the results for the first section some, but the bond strengths of the other cores in this set were also somewhat lower than the second section. The average bond strength for the second section was similar to the results from the other sections. The bond strengths were also very good. Even the cores taken where the pads were removed for measuring the application rates had high bond strengths. The fact that the underlying surface had been placed only a few days and was still fresh probably contributed to the good bond strengths even at the low application rates.

TABLE 10. Tack Coat Application Rates for Project 2

Section	Pad #	Wt. after Tack coat	Beginning Pad Wt.	Residue	App. Rate (gsy)	
Low 1	1	52.8	44.8	8.0	0.018	
	2	53.3	40.9	12.4	0.029	
	3	56.7	44.8	11.9	0.027	
	4	48.1	36.4	11.7	0.027	
	5	53.2	40.4	12.8	0.030	
	6	51.0	39.8	11.2	0.026	
	7	49.1	41.0	8.1	0.019	
	Avg.					0.025
	St. Dev.					0.005
Low 2	8	115.2	40.6	74.6	0.172	
	9	143.6	43.5	100.1	0.231	
	10	136.6	41.3	95.3	0.220	
	11	132.0	40.2	91.8	0.212	
	12	136.4	38.9	97.5	0.225	
	13	117.0	39.1	77.9	0.180	
	14	94.9	38.2	56.7	0.131	
	Avg.					0.196
	St. Dev.					0.036
Med.	15	53.9	37.0	16.9	0.039	
	16	64.1	40.0	24.1	0.056	
	17	53.6	36.0	17.6	0.041	
	18	73.6	48.9	24.7	0.057	
	19	62.7	40.5	22.2	0.051	
	20	64.0	40.9	23.1	0.053	
	21	65.6	40.3	25.3	0.058	
	22	60.5	38.5	22.0	0.051	
	23	60.8	40.1	20.7	0.048	
	24	62.5	39.4	23.1	0.053	
	Avg.					0.051
	St. Dev.					0.007
High	25	64.9	43.9	21.0	0.063	
	26	60.0	37.0	23.0	0.066	
	27	62.6	41.2	21.4	0.065	
	28	64.1	41.1	23.0	0.063	
	29	64.6	39.9	24.7	0.068	
	30	65.0	42.5	22.5	0.064	
	31	57.5	40.1	17.4	0.049	
	32	61.7	39.4	22.3	0.068	
	Avg.					0.063
	St. Dev.					0.006

TABLE 11. Bond Strength Results for Project 2

Section	Avg. App. Rate (gsy)	Core #	Load to Failure (lbs)	Bond Strength (psi)
Low 1	0.025	1	1300	46.0
		2	3050	107.9
		4	2950	104.3
		5	2700	95.5
		Avg.		88.4
		Std. Dev.		28.8
Low 2	0.020	6	3680	130.2
		7	4800	169.8
		9	4480	158.4
		10	4800	169.8
		Avg.		157.0
		Std. Dev.		18.7
Med	0.052	12	4500	159.2
		13	5450	192.8
		15	3740	132.3
		16	3880	137.2
		Avg.		158.2
		Std. Dev.		24.7
High	0.063	18	3400	120.3
		19	4650	164.5
		20	3300	116.7
		21	2160	76.4
		22	4200	148.5
		Avg.		125.3
		Std. Dev.		33.8
		Pads		3A
3B*	1150			40.7
8A	3700			130.9
8B	3700			130.9
14A	5480			193.8
14B	5450			192.8
17A	4550			160.9
17B	4800			169.8
Avg.				155.0
Std. Dev.				33.5

* outlier

Field project 3 was located on State Highway 22 West in Roanoke, Alabama in Randolph County. Tack coat test sections were set up on September 30, 2004. The contractor used a CRS-2 emulsion as the tack coat. The tack coat was applied over a milled asphalt surface. As shown in Figure 23, the tack coat was applied using a hand wand sprayer due to problems with the spray bar on the distributor truck. The measured application rates are shown in Table 10.



Figure 23. Application of Tack Coat with Hand Wand on Project 3

The application rates measured on this project were about half of the target rates for each section. This difference is not surprising considering the use of the hand wand to apply the tack coat. Accurately calibrating the tack coat application rate using the hand wand sprayer is not possible.

Cores were taken from these sections the next day because of trouble with the water pump on the core rig. Traffic was allowed on the sections overnight before the coring took place. This highway has a higher volume of traffic because a hospital is located on this road. The weather was warm the day the hot mix was placed and the next day when the cores were cut. A very high average bond strength (273.5 psi) was obtained for the section with the lowest application rate. For the medium and high tack rate sections, good bond strengths were obtained. Good bond was also measured for the cores taken from where the pads were removed. The traffic on the sections before coring may have contributed to high bond strengths for this project. The optimum application rate for tack coat for this project appears to be 0.014 gal/yd².

TABLE 12. Application Rates for Project 3 Test Sections

Section	Pad #	Wt. After Tack Coat	Wt. Before Tack Coat	Residue	App. Rate (gsy)	
High	85	47.9	39.0	8.9	0.021	
	86	59.0	43.1	15.9	0.037	
	87	64.1	41.9	22.2	0.051	
	88	74.4	49.6	24.8	0.057	
	89	66.5	40.6	25.9	0.060	
	90	64.2	42.1	22.1	0.051	
	91	60.7	40.6	20.1	0.046	
	92	56.3	38.1	18.2	0.042	
	93	60.9	40.4	20.5	0.047	
	94	59.0	40.3	18.7	0.043	
	95	56.3	40.7	15.6	0.036	
	96	59.3	50.2	9.1	0.021	
	Avg.					0.043
	Std. Dev.					0.013
Med	97	42.5	39.6	2.9	0.007	
	98	49.4	43.6	5.8	0.013	
	99	49.0	40.2	8.8	0.020	
	100	52.7	41.2	11.5	0.027	
	101	55.1	42.3	12.8	0.030	
	102	59.9	44.7	15.2	0.035	
	103	60.7	49.7	11.0	0.025	
	104	48.0	38.6	9.4	0.022	
	105	52.3	41.3	11.0	0.025	
	106	52.7	42.0	10.7	0.025	
	107	48.3	38.9	9.4	0.022	
	108	51.2	44.1	7.1	0.016	
	Avg.					0.022
	Std. Dev.					0.008
Low	109	39.7	37.4	2.3	0.005	
	110	46.6	41.9	4.7	0.011	
	111	45.7	39.8	5.9	0.014	
	112	45.0	39.6	5.4	0.012	
	113	46.4	39.8	6.6	0.015	
	114	49.3	41.7	7.6	0.018	
	115	47.3	38.6	8.7	0.020	
	116	44.2	36.9	7.3	0.017	
	117	50.0	43.4	6.6	0.015	
	118	43.7	37.0	6.7	0.015	
	119	46.8	41.7	5.1	0.012	
	120	46.5	43.0	3.5	0.008	
	Avg.					0.014
Std. Dev.					0.004	

TABLE 13. Bond Strength Results for Project 3

Section	Avg. App. Rate (gsy)	Core #	Failure Load (lbs)	Bond Strength (psi)
Low	0.014	3-1	5880	208.0
		3-3	8320	294.3
		3-4	9000	318.3
		Avg.		273.5
		Std. Dev.		58.0
Med	0.022	2-1	4320	152.8
		2-3	5700	201.6
		2-4	3900	137.9
		Avg.		164.1
		Std. Dev.		33.3
High	0.043	1-1	2920	103.3
		1-3	3350	118.5
		1-4	4020	142.2
		Avg.		121.3
		Std. Dev.		19.6
Pads		1-2A	3500	123.8
		1-2B	3140	111.1
		2-2A	5300	187.4
		2-2B	3310	117.1
		3-2A	4180	147.8
		3-2B	6240	220.7
		Avg.		151.3
		Std. Dev.		44.0

Field project 4 was located on I-85 between Exits 26 and 22 near Shorter, Alabama. Tack coat test sections were set up on October 4, 2004. The contractor used a PG 64-22 binder as the tack coat. The tack coat was applied using a distributor truck spray bar. The tack coat was applied on a milled surface and overlaid with a leveling course. The measured application rates for this project are given in Table 14.

Cores were taken from these sections the same day and no traffic was applied to these sections. Since the weather was warm, ice was placed on the areas where the cores were to be cut to cool the pavement before coring.

The bond strength results for project 4 are shown in Table 15. These results indicate that the bond strengths were affected little by the range of application rates for the PG 64-22. Good bond strengths were also measured for cores taken in the small areas where the pads were taken up to measure the application rates. It is suspected that the tack from the adjacent sections was tracked by the trucks and paving equipment into the small strips where the pads were placed. Thus, these areas did have some small but unknown amount of tack coat material.

TABLE 14. Tack Coat Application Rates for Project 4

Section	Pad #	Wt. after Tack coat	Beginning Pad Wt.	Wt. of Tack coat	Rate gal/yd ²
Low	121	51.0	41.8	9.2	0.021
	122	52.0	38.8	13.2	0.030
	123	53.0	40.3	12.7	0.029
	124	51.3	41.1	10.2	0.024
	125	53.6	42.5	11.1	0.026
	126	53.5	41.1	12.4	0.029
	127	50.9	40.2	10.7	0.025
	128	56.0	42.5	13.5	0.031
	129	54.2	40.6	13.6	0.031
	130	57.1	43.9	13.2	0.030
	131	50.9	37.8	13.1	0.030
	132	51.1	38.4	12.7	0.029
	Avg.				0.028
	Std. Dev.				0.003
Med.	133	54.0	39.7	14.3	0.033
	134	52.8	39.6	13.2	0.030
	135	49.9	38.5	11.4	0.026
	137	49.7	38.0	11.7	0.027
	138	54.0	40.3	13.7	0.032
	139	54.8	39.5	15.3	0.035
	140	62.4	49.7	12.7	0.029
	141	57.8	43.3	14.5	0.033
	142	57.9	39.6	18.3	0.042
	143	55.7	38.6	17.1	0.039
	Avg.				0.033
	Std. Dev.				0.005
High	145	60.3	38.1	22.2	0.051
	146	58.8	37.8	21.0	0.048
	147	61.6	40.5	21.1	0.049
	148	56.2	39.6	16.6	0.038
	149	66.5	44.6	21.9	0.051
	150	60.6	39.4	21.2	0.049
	152	65.1	40.9	24.2	0.056
	153	59.4	37.8	21.6	0.050
	154	64.1	41.8	22.3	0.051
	155	58.7	37.0	21.7	0.050
	157	55.7	40.7	15.0	0.035
	Avg.				0.048
	Std. Dev.				0.006

TABLE 15. Bond Strength Results for Project 4

Section	Avg. App. Rate (gsy)	Core #	Load to Failure (lbs)	Bond Strength (psi)
Low	0.028	1-1	4350	153.8
		1-2	3350	118.5
		1-4	3580	126.6
		Avg.		133.0
		Std. Dev.		18.5
Med	0.033	2-1	2550	90.2
		2-2	3780	133.7
		2-4	3380	119.5
		Avg.		114.5
		Std. Dev.		22.2
High	0.048	3-1	3020	106.8
		3-2	3800	134.4
		3-4	3050	107.9
		Avg.		116.4
		Std. Dev.		15.6
Pads		1-3A	3820	135.1
		1-3B	3510	124.1
		2-3A	4380	154.9
		2-3B	3590	127.0
		3-3A	4250	150.3
		3-3B	3120	110.3
		Avg.		133.6
		Std. Dev.		16.8

Field project 5 was located on Montgomery County Highway 19 from US 31 south to the Crenshaw County line. Tack coat test sections were set up on March 9, 2005. The contractor used a CRS-2 emulsion as the tack coat material. The tack coat was applied over a 424A-346 ½” A/B leveling mix that had been placed the week before. The weather was cool the day the fieldwork was performed. The air temperature was generally between 50 and 55°F. The tack coat was applied using a distributor truck spray bar (Figures 26 and 27). The application rates are shown in Table 14. Cores were taken from these sections the same day the hot mix was placed.

The bond strengths measured for the test sections are shown in Table 14. These data show that the bond strengths improved as the measured application rate increased to about 0.055 gsy. Since the second and third sections had about the same application rates, their average bond strengths were also nearly the same. From this information, it is impossible to know if the bond strength would have continued to increase or decrease for tack coat application rates approaching the upper specification range.

TABLE 16. Tack Coat Application Rates for Project 5

Section	Pad #	Wt. of Pad after Tack Coat	Beginning Pad Wt.	Wt. of Tack Coat	Rate gal/yd ²	
Low	158	44.1	38.3	5.8	0.013	
	159	62.7	49.6	13.1	0.030	
	160	59.8	46.8	13.0	0.030	
	161	55.1	42.1	13.0	0.030	
	162	55.0	40.2	14.8	0.034	
	163	56.1	41.3	14.8	0.034	
	164	63.4	49.3	14.1	0.033	
	165	50.9	38.8	12.1	0.028	
	Avg.					0.029
	Std. Dev.					0.007
Med.	166	56.1	40.6	15.5	0.036	
	167	58.2	36.3	21.9	0.051	
	168	63.1	38.5	24.6	0.057	
	169	67.0	41.1	25.9	0.060	
	170	67.1	42.2	24.9	0.057	
	171	70.4	45.5	24.9	0.057	
	172	70.8	44.7	26.1	0.060	
	173	66.8	43.1	23.7	0.055	
	Avg.					0.054
	Std. Dev.					0.008
High	174	65.1	38.5	26.6	0.061	
	175	69.0	41.5	27.5	0.063	
	176	68.0	40.3	27.7	0.064	
	177	71.7	44.7	27.0	0.062	
	178	69.6	45.5	24.1	0.056	
	179	65.9	44.5	21.4	0.049	
	180	62.3	41.9	20.4	0.047	
	Avg.					0.058
	Std. Dev.					0.007



Figure 24. Application of CSS-1 Tack Coat on Project 5



Figure 25. Close Up of Application of Tack coat on Project 5

TABLE 16. Bond Strength Results for Project 5

Section	Avg. App. Rate (gsy)	Core #	Load to Failure (lbs)	Bond Strength (psi)
Low	0.029	1	500	17.7
		2	debonded	0.0
		3	700	24.8
		6	1700	60.1
		7	2340	82.8
		Avg.		37.1
		Std. Dev.		33.6
Med.	0.054	9	2860	101.2
		10	3630	128.4
		13	3340	118.1
		14	4250	150.3
		Avg.		124.5
		Std. Dev.		20.6
High	0.058	15	4160	147.1
		16	3380	119.5
		19	3980	140.8
		20	2540	89.8
		Avg.		124.3
		Std. Dev.		25.8
Pads		4	debonded	0.0
		5	2340	82.8
		11	2300	81.3
		12	debonded	0.0
		17	debonded	0.0
		18	debonded	0.0
		Avg.		27.4
		Std. Dev.		42.4

Field project 6 was located on US-280 (Red Mountain Expressway) in Birmingham. This was a unique project consisting of an overlay of Open-Graded Friction Course (OGFC) on a concrete pavement. The OGFC was placed at a target spread rate of 90 pounds/square yard. To assure a good bond on this project, ALDOT specified a CQS-1HP polymer modified emulsion as the tack coat material to be sprayed in a very heavy application. Some of the thick tack coat is expected to penetrate into the voids in the bottom of the OGFC. The first test section was constructed with a target tack application rate of 0.16 gal/yd² total emulsion; the second section had a target application rate of 0.20 gal/yd². For a CQS-1HP, the minimum asphalt residue is 60%. Therefore, the target application rates based on 60% asphalt residue would be 0.096 gal/yd² for section one, and 0.12 gal/yd² for section two.

The tack coat was sprayed with a typical distributor for sections one and two. From Figures 26 and 27, it can be seen that a significant problem with this application process is that the tack coat sticks to the tires of equipment and vehicles better than it sticks to the roadway surface. This not

only makes for a messy and difficult construction operation, but much of the tack coat in the wheel paths is lost, resulting in an ineffective application. For the third section, the tack was applied with a Novachip spreader which is a special spreader equipped with an emulsion tank and spray bar system to apply the polymer modified tack just in front of the auger box for the spreader (Figures 28 and 29). Therefore, this equipment avoids the problems with traffic on the tacked surface. The target tack coat application rate for the Novachip spreader was also 0.20 gal/yd² total emulsion, or 0.12 gal/yd² based on asphalt residue.

The application rates for sections one and two are shown in Table 17. The measured application rates for these sections were significantly higher than the target rates. It was not possible to measure the application rate for section three using ASTM D2995.

TABLE 15. Application Rates for Project 6

Section	Pad #	Wt. after Tack coat	Beginning Pad Wt.	Wt. of Tack coat	Coated Area (yd ²)	Rate (gal/yd ²)	
Low	200	64.9	36.1	28.8	0.082	0.090	
	201	81.1	40.4	40.7	0.093	0.113	
	202	8.9	40.7	31.8	0.097	0.084	
	203	88.9	37.9	51.0	0.097	0.135	
	204	90.1	40.6	49.5	0.093	0.136	
	205	91.9	43.7	48.2	0.089	0.140	
	206	88.3	36.7	51.6	0.084	0.157	
	207	105.9	35.4	70.5	0.088	0.206	
	Avg.						0.133
	Std. Dev.						0.039
High	209	84.4	44.3	40.1	0.093	0.111	
	210	91.5	42.4	49.1	0.082	0.153	
	211	107.6	41.6	66.0	0.088	0.193	
	212	108.6	46.0	62.6	0.086	0.188	
	213	99.9	41.3	58.6	0.081	0.187	
	214	108.8	38.5	70.3	0.091	0.199	
	215	140.6	47.3	93.3	0.097	0.247	
	216	124.9	43.1	81.8	0.097	0.216	
	217	103.9	42.3	61.6	0.095	0.167	
	218	85.7	44.3	41.4	0.081	0.131	
	Avg.						0.179
	Std. Dev.						0.039



Figure 26. Tack Coat Applied with a Typical Distributor Truck on Project 6



Figure 27. CQS-1HP Polymer Asphalt Emulsion as Applied in Section 1 & 2. Note the Strings of Tack Sticking to the Tire



Figure 28. Novachip Spreader Equipped with Tack Tank and Application System



Figure 29. Tack Coat Applied by Novachip Spreader Just in Front of HMA

Bond strength data for project 6 are shown in Table 18. Compared to the other projects, the bond strengths for the test sections on this project are somewhat lower. The third section, which used the Novachip spreader, had higher bond strength than the other sections, but its average bond

strength was lower than that measured on most other projects. This is unexpected since the tack coat material used on this project was a polymer modified asphalt emulsion with a lower penetration residue. The lower bond strengths measured on this project are probably due to the very high application rates. It should be noted that ALDOT has used these high tack coat application rates on similar projects for several years with very good success.

TABLE 18. Bond Strength Results for Project 6

Section	Avg. App. Rate (gsy)	Core #	Load to Failure (lbs)	Bond Strength (psi)
Low	0.133	1	1700	60.1
		2	1700	60.1
		5	900	31.8
		6	1450	51.3
		Avg.		50.8
		Std. Dev.		13.3
High	0.179	7	1600	56.6
		8	1700	60.1
		14	1700	60.1
		16	1100	38.9
		17	1850	65.4
		18	2200	77.8
		Avg.		59.4
		Std. Dev.		11.6
Nova Spreader		19	2600	92.0
		20	2400	84.9
		1	2200	77.8
		2	2700	95.5
		3	2350	83.1
		Avg.		86.7
		Std. Dev.		7.1
Pads		3	1500	53.1
		4	1300	46.0
		11	1550	54.8
		12	1600	56.6
		Avg.		52.6
		Std. Dev.		4.7

Field project 7 was located on US 31 north of Prattville in Autauga County. The tack coat sections were set up on a milled HMA surface on May 16, 2005. A CRS-2 emulsion was used as the tack coat material and it was applied with a typical distributor truck. The application rates for project 7 are shown in Table 19. The measured application rates for the two sections applied with the distributor truck were about half of their respective target rates.

TABLE 19. Tack Coat Application Rates for Project 7

Section	Pad #	Wt. after Tack coat	Beginning Pad Wt.	Wt. of Tack coat	Rate (gal/yd ²)	
Low	219	45.5	43.0	2.5	0.006	
	220	53.5	44.7	8.8	0.020	
	221	50.7	41.2	9.5	0.022	
	222	52.3	49.6	2.7	0.006	
	223	54.6	48.1	6.5	0.015	
	224	53.0	44.3	8.7	0.020	
	225	52.9	44.3	8.6	0.020	
	226	54.5	43.6	10.9	0.025	
	Avg.					0.017
	Std. Dev.					0.007
Med.	227	59.0	48.5	10.5	0.024	
	228	57.3	48.4	8.9	0.021	
	229	58.7	45.4	13.3	0.031	
	230	58.6	45.5	13.1	0.030	
	231	51.6	46.2	5.4	0.012	
	232	59.9	52.2	7.7	0.018	
	233	61.9	41.1	20.8	0.048	
	Avg.					0.026
	Std. Dev.					0.012
High	235	63.9	40.8	23.1	0.069	
	236	69.0	48.5	20.5	0.058	
	237	69.3	48.4	20.9	0.064	
	238	66.5	45.4	21.1	0.058	
	239	69.2	45.5	23.7	0.065	
	240	62.6	46.2	16.4	0.047	
	241	72.9	52.2	20.7	0.059	
	242	60.8	41.1	19.7	0.060	
	Avg.					0.060
	Std. Dev.					0.006

Bond strength results for project 7 are shown in Table 20. For this project, two sets of cores were obtained and tested for each tack coat section. The first set of cores was taken from the wheelpaths of the lane being paved; the second set of cores was taken between the wheelpaths. This was done to evaluate the effect of possible loss of tack coat material due to the material being tracked by the tires of construction equipment. Comparing the average bond strengths from the wheelpaths and between wheelpaths for each section, it is evident that there was no real difference for the low and medium application rate sections. For the high application rate section, the between wheelpath cores had a noticeably higher average bond strength compared to the wheelpath cores. However, a simple t-test of these results found that the difference is not statistically different at $\alpha = 5\%$.

As with a few other projects, all of the sections had good bond strengths. Even the small areas where the pads were placed to measure the application rates that did not have any tack applied

had good bond strengths. The tack coat application rate appeared to have little effect on the bond strengths for this project.

TABLE 20. Bond Strength Results for Project 7

Section	Avg. App. Rate (gsy)	Wheelpath		Between Wheelpaths	
		Core #	Bond Strength (psi)	Core #	Bond Strength (psi)
Low	0.017	1	120.3	2	77.8
		3	111.4	4	134.4
		7	110.0	8	99.0
		9	77.8	10	79.6
		11	99.0	12	128.0
		Avg.	103.7	Avg.	103.8
		Std. Dev.	16.3	Std. Dev.	26.5
Med.	0.026	13	106.1	14	109.3
		15	99.9	16	71.6
		19	88.4	20	117.8
		21	114.9	22	102.6
		23	78.2	24	111.4
		Avg.	97.5	Avg.	102.5
		Std. Dev.	14.5	Std. Dev.	18.1
High	0.06	25	113.5	26	113.2
		27	104.3	28	121.1
		31	137.9	32	212.2
		33	56.6	34	183.6
		35	56.6	36	113.5
		Avg.	93.8	Avg.	148.7
		Std. Dev.	36.1	Std. Dev.	46.1
Pads		5	194.5		
		6	114.9		
		17	129.1		
		18	173.3		
		29	113.5		
		30	113.5		
		Avg.	139.8		
		Std. Dev.	35.3		

Summary of Phase II Results

A histogram of all individual bond strength results from the field phase of this project is shown in Figure 30. As can be seen, the test results of individual core samples ranged from zero to over 300 psi. These results are much less than the bond strengths measured in the laboratory phase of the study. Bond strengths for laboratory specimens at the same temperature with no normal load ranged from around 200 psi to over 400 psi. The average bond strength for all field samples was 108.7 psi. The average bond strength for all of the test sections, including the sections made from cores taken at the pad locations, is slightly different. The average bond strength for the test

sections, based on at least three samples, was 103.7 psi. The pooled standard deviation for bond strengths calculated for each of the sections was 28.7 psi. Figure 31 compares the average and standard deviation for the bond strength determined for each field section. This graph shows a trend of increasing variation of results as the average bond strength increases. Variability of results were also high for sections with low average bond strengths because some cores debonded (i.e. bond strength = 0) and other cores had some bond strength.

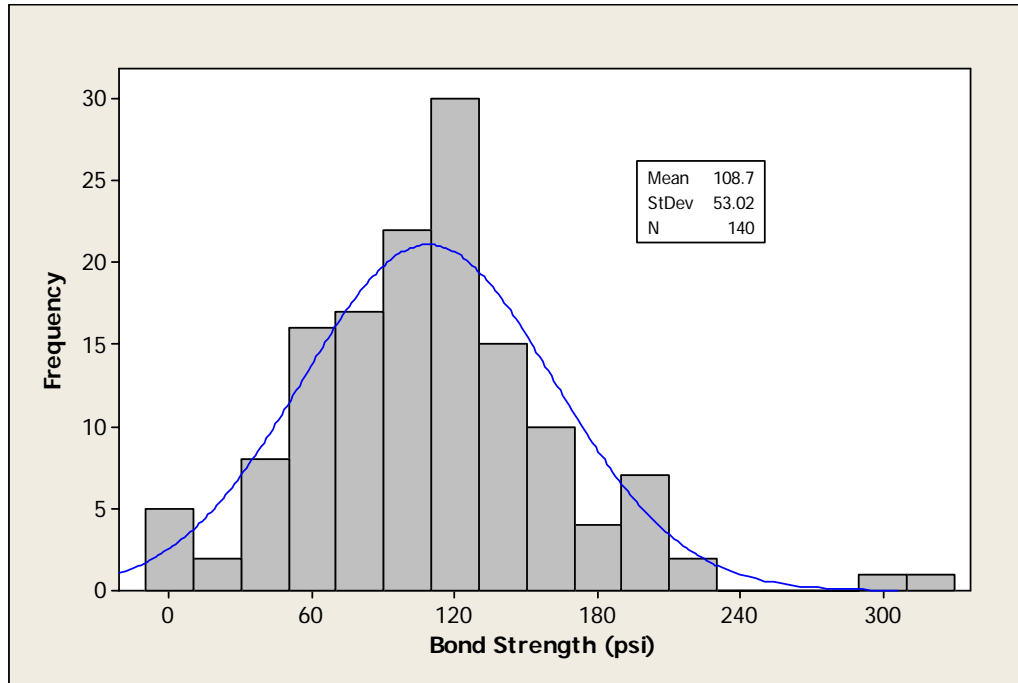

Figure 30. Histogram of Bond Strength Tests for All Samples in Phase II

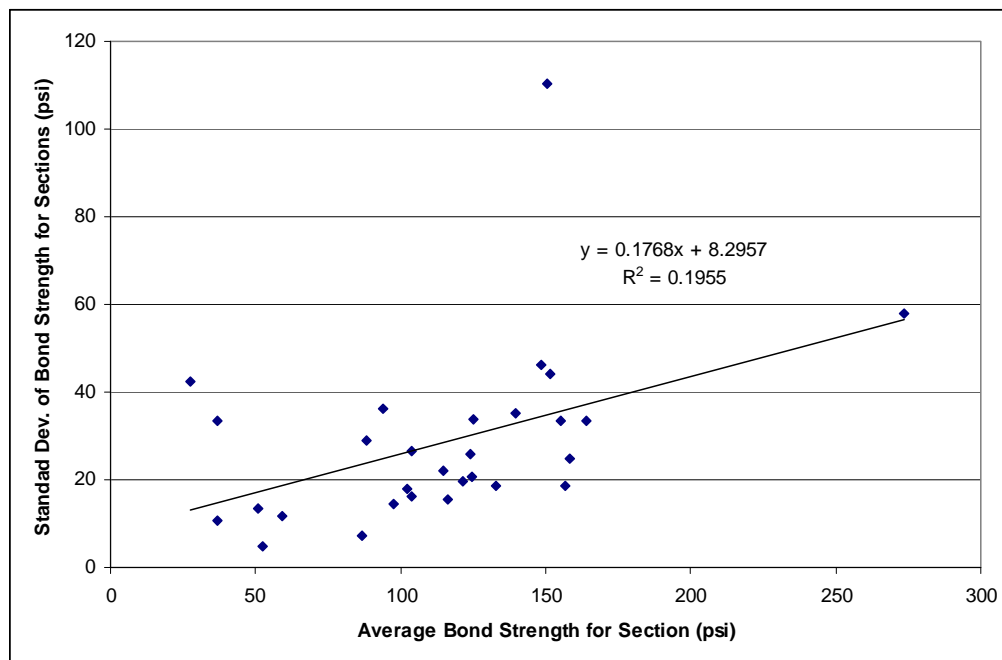

Figure 31. Correlation of Average and Standard Deviation for Bond Strength of Sections

From the available data, there are no clear ranges for good and poor bond strengths. The low end of bond strength begins with failure of the bond during the coring operation. Although this may be affected to some degree by the pavement temperature and the condition of the coring rig, when it is not possible to obtain an intact core for testing, then there is a bond problem. As a preliminary range for the bond strength test results, low bond strengths may include results up to around 50 psi. This value is approximately two standard deviations below the average bond strength for the test sections. Only a few test sections had average bond strengths below this value, and these sections had very low tack coat application rates. Most of the field sections had bond strengths above 100 psi. It is not known at this time if that value is sufficient to resist shear forces that may occur in the pavement. However, the field data suggests that the average bond strength of 100 psi is representative of typical HMA pavement construction. The range of bond strengths between 50 psi and 100 psi is considered marginal. A bond strength result here is the average of at least three samples. These preliminary ranges are based on the results for the various sections and are not based on performance information. In other words, the link between a minimum bond strength and slippage failure has not been established.

Table 21 provides a summary of the key results for the field projects. Comparison of the results of the projects provides some different outcomes and some consistent conclusions. One of the more interesting observations is from the projects with the bond strengths measured on milled surfaces (projects 3, 4, and 7). For these projects, good bonds were measured for all sections and even for the cores taken where the pads had been placed to measure the application rates. This indicates that texture of the surface has a significant impact on bond strength. The irregular surface created by milling seems to significantly enhance the bond.

Only two projects were cored and tested which used paving grade asphalt as the tack coat material. These two projects were Projects 2 and 4. Both of these projects had very good bond strengths. Project 2 evaluated the bond strength between two new HMA layers. It had one day of traffic on the sections before the cores were cut for bond strength testing. Time and/or traffic may have improved the bond strengths for the sections. Project 4 was one of the projects where bond strength was measured on a milled surface. The milled surface is believed to have enhanced the bond strength. Although the laboratory phase showed paving grade asphalt to provide higher bond strengths than the emulsion tack coats, there is insufficient evidence to confirm that finding in the field phase. However, the available information from the field projects does not contradict that observation.

Poor bonds were observed for only a couple sections on a few projects. Project 1 had no bond for the first two sections and a weak bond for the third section. The tack coat application rates determined for each of these sections were very low and the surface of the pavement before the application of the tack was rather dusty from construction traffic. The other field project with poorly bonded sections was project 5. The section with the lowest application rate (0.029 gal/yd²) had an average bond strength of only 37.1 psi and included one core that debonded during the coring operation. Four of the six cores taken where the pads were placed also debonded. The surface of the underlying pavement on project 5 was a new HMA mat which was clean and relatively fresh. A CRS-2 emulsion was used for the tack coat. The results of this project contrast with project 7 which used the same emulsion but the surface was a milled HMA pavement. All of the sections on project 7 had good bond strengths.

TABLE 21. Summary of Results for the Seven Field Projects

Project	Type of Underlying Surface	Tack Coat Type	Optimum App. Rate Based on Residual Asphalt (gal/yd ²)	Highest Bond Strength (psi)	Results/Observations
1	New HMA	Emulsion	N/A	37.1	No or very poor bond due to very low tack application rates (<0.01 gsy). Dusty surface may have contributed to poor bond.
2	New HMA	Paving Grade Asphalt	0.020 to 0.063	158.2	Very good bond strengths for each section, even area where no tack was applied. Bond strengths were not sensitive to application rate.
3	Milled HMA	Emulsion	0.014	273.5	Good bond strengths for all sections, even area where no tack was applied. Highest bond achieved for section with light tack.
4	Milled HMA	Paving Grade Asphalt	0.028	133.0	Good bond strengths for all sections, even area where no tack was applied. Highest bond achieved for section with light tack.
5	New HMA	Emulsion	0.054	124.5	Weak bond strengths were measured for lowest section at 0.029 gsy. Good bond strengths for application rates of 0.54 to 0.58 gsy.
6	Concrete	Polymer-modified Emulsion		86.7	The highest bond strengths were for section placed with Novachip spreader.
7	Milled HMA	Emulsion	0.017 to 0.060	148.7	Good bond strengths were measured for all sections, even area where no tack was applied. Highest bond achieved for section with heavy tack.

CONCLUSIONS

From the laboratory study, it was found that conducting bond strength tests at low temperature is not practical. The draft procedure was written to be run at the intermediate temperature (77°F) because the intermediate temperature yielded a wider range of bond strengths for different materials than the high temperature. At the intermediate test temperature, the bond strength was not very sensitive to the normal pressure. Therefore, at 77°F it is not necessary to use normal loading during the bond strength test.

If the bond strength test is to be run at a high temperature to investigate the tack coat properties at high temperature or for other purposes, it is recommended a 20 psi normal pressure be applied to avoid premature failure of the testing samples.

The results of the laboratory experiment indicate that all of the main factors and several interactions among factors affect bond strength.

- Mixture type was a significant factor. Overall, analysis shows that the fine-graded, smaller NMAS mixture has higher bond strengths than the coarse-graded, larger NMAS mixture. However, there are significant interactions of mix type (texture) with each of the other variables that will reverse this trend in some cases.
- In most cases, the PG 64-22 provided higher bond strengths than the two emulsion tack coats.
- Higher strengths were generally evident at the lower application rate for each of the tack coat materials.
- The effect of normal pressure was more pronounced at the higher temperature. This was anticipated since the stiffness of the tack coat is significantly reduced at the higher temperature and so the effect of friction at the interlayer is more evident. However, at 50°F and 77°F, bond strength was not sensitive to normal pressure.
- Test temperature has a dominant effect on bond strength. On average, bond strengths were 2.3 times greater at 50°F compared to 77°F; and the bond strengths at 140°F were about one sixth of the bond strength at 77°F.

In the field phase of this study, a wide range of tack coat application practices was observed. The use of the draft bond strength procedure was successfully demonstrated. This part of the study yielded several important observations.

- ASTM D 2995, *Standard Practice for Estimating Application Rate of Bituminous Distributors* (23) was found to be an effective method for checking the application rate of tack coats. Using this method, several distributor trucks used in the study were found to not be well calibrated. One advantage of this method is that the measurement of the application rate is in terms of residual asphalt for emulsion tack coat materials. This removes the uncertainty of how much the emulsion may have been diluted.
- Milled HMA surfaces appear to significantly enhance the bond strength with the next HMA pavement layer.
- Although the few field projects with paving grade asphalt tack coat had good bond strengths, there were other circumstances for these projects which may have influenced the results. Therefore, there does not appear to be sufficient evidence at this time to conclude that paving grade asphalt is superior to asphalt emulsion tack coats.

- A preliminary minimum bond strength using the draft bond strength procedure is 100 psi. This limit is based on the average of at least three test samples. Marginal bond strength results appear to be between 50 and 100 psi. Bond strength results below 50 psi are considered poor. These preliminary ranges need to be verified with further work.
- Based on one project, there was not a significant difference in bond strength for cores taken from within the wheelpath and cores taken between wheelpaths.
- The Novachip spreader, which applies the tack material just in front of where the mix contacts the pavement, avoids the mess and problems of tracking of tack coat materials by construction equipment or cross-over traffic. The bond strengths measured for the section placed with the Novachip spreader were significantly higher than similar sections placed with conventional paving equipment.

RECOMMENDATIONS

Based on the findings reported in this study, the following recommendations are suggested for the Alabama Department of Transportation to consider for implementation.

1. The Department should include training on the inspection of roadway surfaces and proper application of tack coats in its Roadway Technician certification course.
2. Tack coat application rates should be checked on paving projects prior to paving.
3. The ALDOT specifications for tack coat materials and application rates are satisfactory. To aid in inspection, the application rate for emulsified asphalt tack coat should be specified in terms of residual asphalt. The method recommended for checking the application rate of any tack coat application is ASTM D 2995, *Standard Practice for Estimating Application Rate of Bituminous Distributors*.
4. The simple bond strength procedure developed in this study and included in Appendix B can be used to assess the bond strength between HMA pavement layers. A minimum bond strength of 100 psi is recommended as a preliminary criterion for evaluating newly constructed pavements.

There are several issues that need to be further studied:

1. The projects and test sections constructed as part of this study should be monitored for a few years to evaluate their performance and identify any sections that do not perform well.
2. More work is needed to better define critical conditions for slippage failures such as pavement temperature, depth of layer interface, and stress magnitudes to help set more definitive limits for minimum bond strengths between pavement layers.
3. Bond strengths, tack coat types, and application rates for pavement layers on other types of surfaces such as old HMA pavements and surface treatments should be investigated. More field projects with the different types of tack coat materials should also be considered.
4. The precision of the bond strength procedure should be further studied.
5. The change in bond strength over time and traffic should be evaluated to aid in analysis of pavement failures.

6. Paving machines equipped with tack coat application systems should be more thoroughly evaluated. Use of this type of equipment has significant advantages if it can be assured that the tack coat material is uniformly applied and a good bond is developed between the existing surface and the new HMA layer

REFERENCES

1. Hachiya, Y., and K. Sato, "Effect of Tack Coat on Bonding Characteristics at Interface Between Asphalt Concrete Layers." Proceedings of the 8th International Conference on Asphalt Pavements, 1997.
2. Hot Mix Asphalt Construction Reference for Quality HMA Pavements, QIP 112, National Asphalt Pavement Association, 2000.
3. Roffe J.C., and Chaignon, F., "Characterisation Tests on Bond Coats: Worldwide Study, Impact, Tests, and Recommendations", 3rd International Conference Bituminous Mixtures and Pavements, Thessaloniki, 2002.
4. Hot-Mix Asphalt Paving Handbook 2000, US Army Corps of Engineers, AC 150/5370-14A, Appendix 1.
5. Roberts, F.L., Kandhal, P.S., Brown, E.R., Lee, D.Y, and Kennedy, T.W., Hot Mix Asphalt Materials, Mix Design, and Construction, NAPA Education Foundation, Second Edition, 1996.
6. A Guide for Hot Mix Asphalt Pavement, TAS-30, National Asphalt Pavement Association.
7. A Basic Asphalt Emulsion Manual, MS-19, Second Edition, The Asphalt Institute.
8. The Asphalt Handbook, MS-4, 1989 Edition, The Asphalt Institute
9. Construction of Hot Mix Asphalt Pavements, MS-22, Second Edition, The Asphalt Institute.
10. Cooley, L.A., "No-Tack Inlay on Milled Surface: Project Report", NCAT Report No. 99-2, February, 1999.
11. King, G, and R. May, "New Approaches to Tack Application", presentation made to the 83rd Annual Meeting of the Transportation Research Board, Washington, D.C., 2003.
12. Uzan, J., M. Livneh, and Y. Eshed, "Investigation of Adhesion Properties Between Asphalt Concrete Layers." Asphalt Paving Technology, Vol.47, Proceedings of the Association of Asphalt Paving Technologists, Technical Sessions, Feb. 1978.
13. Molenaar A.A.A., J.C.P. Heerkens, and J.H.M. Verhoeven. "Effects of Stress Absorbing Membrane Interlayers." Asphalt Paving Technology, Vol.55, Proceedings of the Association of Asphalt Paving Technologists, 1986.
14. Mohammad L.N., M. Abdur Raqib, and Baoshan Huang, "Influence of Asphalt Tack Coat Materials on Interface Shear Strength", Transportation Research Record 1789, Transportation Research Board, 2002.
15. Collep, A.C., N.H. Thom, and C. Sangiorgi, "Assessment of Bond Condition Using the Luetner Shear Test," Institution of Civil Engineering Journal of Transport, 2003.
16. Sholar, G.A., G.C. Page, J.A. Musselman, P.B. Upshaw, and H.L. Moseley, "Preliminary Investigation of a Test Method to Evaluate Bond Strength of Bituminous Tack Coats", Journal of the Association of Asphalt Pavement Technologists, Volume 73, 2004.

17. Santagata, E., and F. Canestari, "Tensile and Shear Tests of Interfaces in Asphalt Mixtures: a New Perspective on Their Failure Criteria," Proceeding of the 2nd International Symposium on Highway Surfacing, Ilster, 1994.
18. Canestari, F., and M. Bocci, "Influence of the Old Pavement Surface Conditions on the Effectiveness of Tack Coat Emulsions," 2nd World Congress on Emulsion, Bordeaux, 1997
19. Santagata, E., and F. Canestari, "Temperature Effects on the Shear Behavior of Tack Coat Emulsions Used in Flexible Pavements," presented to the International Journal of Pavement Engineering, 2003.
20. ATTACKER™ A Tack Coat Testing Device, Operator's Guide, InstroTek, Inc. 2005.

APPENDIX A
Laboratory Mix Designs

4.75 mm NMAS Mixture

Component Materials	Source	Approx. Percentage
Pre-Graded Lab Stock Grait	Vulcan Matls., Columbus, GA	94.2%
PG 67-22 Asphalt Binder	Ergon, Jackson, MS	5.8%

Verified Batch Gradation

Sieve	Percent Passing
25.0 mm	100
19.0 mm	100
12.5 mm	100
9.5 mm	100
4.75 mm	95
2.36 mm	75
1.18 mm	54
0.60 mm	42
0.30 mm	30
0.15 mm	20
0.075 mm	12.0
Gsb	2.669
Optimum Pb	5.8%

Verified Mix Design Properties

Gmm @ Opt. Pb	2.476
Ndesign	100
Air Voids	4.2%
VMA	16.3%
VFA	74.2%
%Gmm @ Nini	88.7%
P ₂₀₀ /P _{be}	2.2

19.0 mm NMAS Mixture

Component Materials	Source	Approx. Percentage
Pre-Graded Lab Stock Grait	Vulcan Matls., Columbus, GA	95.6%
PG 67-22 Asphalt Binder	Ergon, Jackson, MS	4.4%

Verified Batch Gradation

Sieve	Percent Passing
25.0 mm	100
19.0 mm	95
12.5 mm	80
9.5 mm	68
4.75 mm	45
2.36 mm	29
1.18 mm	19
0.60 mm	14
0.30 mm	11
0.15 mm	9
0.075 mm	4.0
Gsb	2.660
Optimum Pb	5.8%

Verified Mix Design Properties

Gmm @ Opt. Pb	2.525
Ndesign	100
Air Voids	4.3%
VMA	13.2%
VFA	67.3%
%Gmm @ Nini	86.2%
P ₂₀₀ /P _{be}	1.1

APPENDIX B

Draft Test Method for Determining Bond Strength

DRAFT

**ALABAMA DEPARTMENT OF TRANSPORTATION
BUREAU OF MATERIALS AND TEST
ALDOT-XXX**

**STANDARD TEST METHOD FOR DETERMINING THE BOND STRENGTH
BETWEEN LAYERS OF AN ASPHALT PAVEMENT**

1. SCOPE

- 1.1 This test method covers the determination of the interface bond shear strength between pavement layers using core samples.
- 1.2 This test shall be performed on 150 mm (6 in.) diameter cores or specimens of asphalt concrete.
- 1.3 This test is applicable if the asphalt overlay thickness as well as the thickness of the base concrete retrieved by coring are not less than 50 mm (2 in.) and not greater than 150 mm (6 in), each.
- 1.4 This standard may involve hazardous materials, operations, and equipment. This standard does not purport to address all of the safety problems associated with its use. It is the responsibility of the user of this procedure to establish appropriate safety and health practices and determine the applicability of regulatory limitations prior to use.

2. REFERENCED DOCUMENTS

- 2.1 AASHTO T-169, Standard Practice for Sampling Bituminous Paving Mixtures
- 2.2 AASHTO T-245 Standard Method of Test for Resistance to Plastic Flow of Bituminous Mixtures Using Marshall Apparatus

3. OBTAINING ROADWAY CORE SPECIMENS

- 3.1 Allow the pavement to cool before coring. Ice may be used to accelerate cooling before coring. Mark the direction of traffic on roadway surface before coring so that it can be identified on each core.
- 3.2 Cores shall be taken full depth so that no prying action is needed to extract the cores from the pavement. Care shall be taken to avoid stress or damage to the interface during coring, handling, or transporting. If a core debonds at the interface of interest during the coring operation, make note of it on the coring report.

- 3.3 Label core specimens with a paint pen or keel.

4. APPARATUS

- 4.1 Bond Test Device - The device used for the bond shear test shall be designed to accommodate a 6 in (150 mm) diameter test specimen. The device shall have a metal cylindrical specimen holder and a sliding metal loading head with a concave surface having a 3 in. (75 mm) radius of curvature is required to apply load to the specimen. The gap between the specimen holder and the sliding loading head shall be ¼ inches. The bond test device is illustrated in Figure 1.
- 4.2 Loading Machine - The loading machine shall produce a uniform vertical movement of 2 in. (50.8 mm)/min. The Marshall Stability test apparatus or other mechanical or hydraulic testing machine may be used provided the rate of movement is maintained at 2 in. (50.8 mm)/min while the load is applied.
- 4.3 Wet masonry saw.

5. PREPARATION OF TEST SPECIMENS

- 5.1 Number of Test Specimens – a single test shall consist of at least three specimens.
- 5.2 Roadway core specimens shall be 6 inch (150 mm) diameter with all surface of the perimeter perpendicular to the surface of the core within ¼ inches (7 mm). If the height of the core above or below the interface being tested is greater than 3 inches (75 mm), it shall be trimmed with a wet masonry saw to a height of approximately 3 inches (75 mm).
- 5.3 Mark the location of the interface layer with white or silver paint.

6. PROCEDURE

- 6.1 Specimen preparation – Measure the diameter of the core and the thickness of the overlay to the nearest 0.05 inches (1 mm).
- 6.2 Specimen conditioning – The specimens shall be allowed to stabilize at the test temperature of $77\pm 2^{\circ}\text{F}$ ($25\pm 1^{\circ}\text{C}$) for a minimum of 2 hours.
- 6.3 Specimen positioning – Orient the core in the bond strength device so that the direction of traffic marked on the core is vertical and the marked interface is centered between the edge of the loading block and the edge of the loading head.

- 6.4 Align the loading head adjacent to the bonded interface. The loading head shall rest parallel to the bonded interface on the asphalt overlay portion of the specimen. Sample positioning and loading is shown in Figure 1.
- 6.5 Rate of displacement – Apply the displacement continuously and without shock, at a constant strain rate of 2 inch per minute until failure occurs. Record the maximum load, P_{MAX} , carried by the specimen during the test.

7. CALCULATION

Calculate the bond shear strength, S_B , as follows:

$$S_B = P_{MAX} / A$$

where:

S_B = bond shear strength, psi

P_{MAX} = maximum load applied to specimen, lbf

A = cross-sectional area of test specimen, in²

and :

$$A = \frac{\pi D^2}{4}$$

where:

A = cross-sectional area of test specimen, in²

D = diameter of test specimen, in

8. REPORT

- 8.1 Core number or identification, sampling date, and test date.
- 8.2 Failure surface. Identify if failures occurred at the interface, in the existing layer, or in the overlay.
- 8.3 Note the appearance of the interface including any contaminants, milling striations, stripping, tack coat streaks, etc.
- 8.4 Test results.
 - 8.4.1 Specimen dimensions – including thickness of the overlay asphalt, thickness of existing layer, the diameter, and the cross-section area.
 - 8.4.2 Maximum load applied, nearest 50 lbf.
 - 8.4.3 Bond shear strength, nearest psi.

8.4.4 Average and standard deviation of bond strength for the set of cores.

9. PRECISION AND BIAS

9.1 No precision and bias statements are available at this time.

10. KEYWORDS

10.1 Bond Strength, Asphalt Overlay, Tack Coat, Shear Strength, Slippage Failure

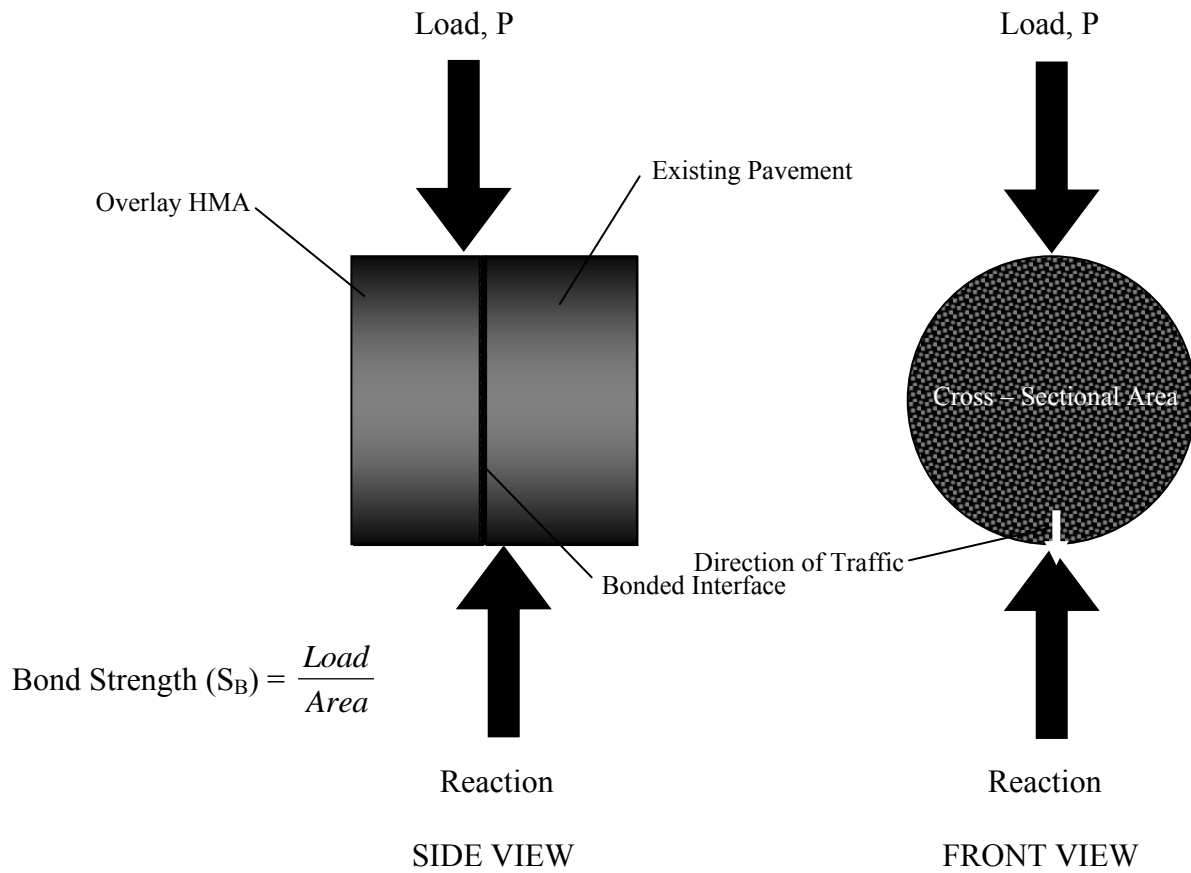

Figure 1. Loading Scheme Used for the Bond Strength Test