

DOT/FAA/TC-22/46

Federal Aviation Administration
William J. Hughes Technical Center
Aviation Research Division
Atlantic City International Airport
New Jersey 08405

In-Service Performance of Airport Flexible Pavements Constructed Following State Specifications for Highway Pavement Materials

April 2023

Final Report

This document is available to the U.S. public through the National Technical Information Services (NTIS), Springfield, Virginia 22161.

This document is also available from the Federal Aviation Administration William J. Hughes Technical Center at actlibrary.tc.faa.gov.



U.S. Department of Transportation
Federal Aviation Administration

NOTICE

This document is disseminated under the sponsorship of the U.S. Department of Transportation in the interest of information exchange. The United States Government assumes no liability for the contents or use thereof. The United States Government does not endorse products or manufacturers. Trade or manufacturer's names appear herein solely because they are considered essential to the objective of this report. The findings and conclusions in this report are those of the author(s) and do not necessarily represent the views of the funding agency. This document does not constitute FAA policy. Consult the FAA sponsoring organization listed on the Technical Documentation page as to its use.

This report is available at the Federal Aviation Administration William J. Hughes Technical Center's Full-Text Technical Reports page: actlibrary.tc.faa.gov in Adobe Acrobat portable document format (PDF).

1. Report No. DOT/FAA/TC-22/46		2. Government Accession No.		3. Recipient's Catalog No.	
4. Title and Subtitle IN-SERVICE PERFORMANCE OF FLEXIBLE AIRPORT PAVEMENTS CONSTRUCTED FOLLOWING STATE SPECIFICATIONS FOR HIGHWAY PAVEMENT MATERIALS				5. Report Date April 2023	
				6. Performing Organization Code ANG-E262	
7. Author(s) West, R. C., Rodezno, M. C., Leiva, F., and Musselman, J. A.				8. Performing Organization Report No.	
9. Performing Organization Name and Address National Center for Asphalt Technology Auburn University 277 Technology Parkway Auburn, AL, 36830				10. Work Unit No. (TRAIS)	
				11. Contract or Grant No. 692M15-19-T-00026	
12. Sponsoring Agency Name and Address Federal Aviation Administration Office of Airport Safety & Standards Airport Engineering Division Airport Design and Construction Branch 800 Independence Avenue SW Washington DC 20591				13. Type of Report and Period Covered Final Report	
				14. Sponsoring Agency Code AAS-110	
15. Supplementary Notes The Federal Aviation Administration Airport Technology Research and Development Contracting Officer Representative (COR) was Dr. Navneet Garg.					
16. Abstract <p>The Federal Aviation Administration (FAA) Reauthorization Act of 2018, Section 136 requires the FAA to allow the use of state highway specifications for airfield pavement construction at non-primary airports serving aircraft with a gross weight less than 60,000 lb if requested by the state. To confirm that state highway specifications provide an acceptable level of performance when used on airport pavements, the FAA initiated this project to compare the performance of airports constructed using state highway specifications with those constructed using FAA specifications. Performance data and specifications from 40 airport projects in five states were analyzed, with 21 using FAA specifications and 19 using state highway specifications. Based on the summarized pavement condition index (PCI) ratings from those projects (which are based on visual condition surveys and do not consider structural or functional performance), it was determined that the performance of airport asphalt pavements constructed using state highway specifications is statistically equivalent to asphalt pavements constructed using FAA specifications. The evaluations encompassed performance periods ranging from 1 to 15 years. Performance trends for the statistical analysis conducted showed an approximate PCI rating of 60 at year 14 for pavements constructed with both types of specifications. It was also determined that climate-based distresses were the predominant mode of distress for both FAA and state highway specification projects, with longitudinal and transverse cracking and weathering as the most prevalent types of distresses. The number of distresses that were load related was relatively minor, as only 8 of the 40 projects evaluated had load-related distresses. Of those projects, five used state highway specifications, and three used FAA specifications.</p>					
17. Key Words Asphalt pavements, Airport pavements, Pavement condition index (PCI), P-401 Specifications, Airport pavement performance			18. Distribution Statement This document is available to the U.S. public through the National Technical Information Service (NTIS), Springfield, Virginia 22161. This document is also available from the Federal Aviation Administration William J. Hughes Technical Center at actlibrary.tc.faa.gov .		
19. Security Classif. (of this report) Unclassified		20. Security Classif. (of this page) Unclassified		21. No. of Pages 221	22. Price

TABLE OF CONTENTS

	Page
EXECUTIVE SUMMARY	xiii
1. INTRODUCTION	1
2. OBJECTIVE AND SCOPE	3
3. LITERATURE REVIEW	3
3.1 Traffic Loading Analysis	3
3.1.1 Traffic Stream Composition	3
3.1.2 Load Repetitions	5
3.1.3 Annual Departures and Traffic Cycles	6
3.2 Specifications for Asphalt Highway and Airport Pavements	6
3.2.1 Materials	7
3.2.2 Mix Design	9
3.2.3 Quality Control	11
3.2.4 Acceptance	12
3.2.5 Construction	13
3.3 Performance-related Specifications	13
3.3.1 Types of Specifications	14
3.3.2 Specification Evolution	17
3.3.3 Performance Specifications for Highway Pavements	18
3.3.4 Performance Specifications/Characteristics for Airport Pavements	19
3.3.5 Basic Elements and Terminology	20
3.4 Pavement Distresses and Pavement Condition Evaluation	20
3.4.1 Pavement Condition Evaluations	21
3.4.2 Airfield Asphalt Pavement Distresses	24
3.5 Summary of Literature Review	33
4. METHODOLOGY	34
5. PROJECT SUMMARIES	45
5.1 Georgia	45

5.1.1	Columbus Airport	45
5.1.2	Albany Airport	46
5.1.3	Athens-Ben Epps Airport	46
5.1.4	Winder-Barrow Airport	46
5.1.5	Russell Regional Airport	46
5.1.6	Lumpkin County-Wimpys Airport	47
5.2	Illinois	47
5.2.1	Waukegan National Airport	47
5.2.2	Edgar County Airport	48
5.2.3	Bolingbrook's Clow International Airport	49
5.2.4	DuPage Airport	49
5.2.5	Chicago Executive Airport	50
5.3	Indiana	51
5.3.1	Anderson Municipal Airport	51
5.3.2	Columbus Municipal Airport	51
5.3.3	Logansport-Cass County Airport	52
5.3.4	Peru Municipal Airport	52
5.4	Michigan	52
5.4.1	Cheboygan County Airport	53
5.4.2	Houghton County Memorial Airport	53
5.4.3	Kirsch Municipal Airport	54
5.4.4	Marlette Township Airport	55
5.4.5	Oakland County International Airport	56
5.4.6	St. Clair County International Airport	56
5.5	Wisconsin	57
5.5.1	Prairie du Chien Municipal Airport	57
5.5.2	Fort Atkinson Municipal Airport	58
5.5.3	Crandon Municipal Airport	59
5.5.4	Clintonville Municipal Airport	60
5.5.5	Oconto J. Douglas Bake Municipal Airport	60
5.5.6	Amery Municipal Airport	61
5.5.7	Baraboo-Wisconsin Dells Regional	61
5.5.8	Bloyer Field	62
5.5.9	Cumberland Municipal Airport	63
5.5.10	East Troy Municipal Airport	63
5.5.11	Fond du Lac County Airport	65
5.5.12	Park Falls Municipal	65

6.	SPECIFICATIONS FOR ASPHALT HIGHWAY AND AIRPORT PAVEMENTS	66
6.1	Aggregate Requirements	67
	6.1.1 Summary of Differences	70
6.2	Asphalt Binder	70
	6.2.1 Federal Aviation Administration	70
	6.2.2 Georgia Department of Transportation	70
	6.2.3 Illinois Department of Transportation	70
	6.2.4 Indiana Department of Transportation	70
	6.2.5 Michigan Department of Transportation	70
	6.2.6 Wisconsin Department of Transportation	71
	6.2.7 Summary of Differences	71
6.3	Mix Design	71
	6.3.1 Federal Aviation Administration	71
	6.3.2 Georgia Department of Transportation	71
	6.3.3 Illinois Department of Transportation	72
	6.3.4 Indiana Department of Transportation	72
	6.3.5 Michigan Department of Transportation	72
	6.3.6 Wisconsin Department of Transportation	73
	6.3.7 Summary of Differences	73
6.4	Quality Control	73
	6.4.1 Federal Aviation Administration	73
	6.4.2 Georgia Department of Transportation	74
	6.4.3 Illinois Department of Transportation	74
	6.4.4 Indiana Department of Transportation	74
	6.4.5 Michigan Department of Transportation	74
	6.4.6 Wisconsin Department of Transportation	75
	6.4.7 Summary of Differences	75
6.5	Acceptance	75
	6.5.1 Federal Aviation Administration	75
	6.5.2 Georgia Department of Transportation	76
	6.5.3 Illinois Department of Transportation	76
	6.5.4 Indiana Department of Transportation	76
	6.5.5 Michigan Department of Transportation	76
	6.5.6 Wisconsin Department of Transportation	76
	6.5.7 Summary of Differences	77

6.6	Construction	77
6.6.1	Federal Aviation Administration	77
6.6.2	Georgia Department of Transportation	77
6.6.3	Illinois Department of Transportation	77
6.6.4	Indiana Department of Transportation	77
6.6.5	Michigan Department of Transportation:	77
6.6.6	Wisconsin Department of Transportation-Specification P 401	77
6.6.7	Summary of Differences	77
7.	FINDINGS AND DISCUSSION	78
8.	CONCLUSIONS AND RECOMMENDATIONS	83
9.	REFERENCES	84

APPENDICES

- A—Airport Reports
- B—Comparison of State and FAA Specifications
- C—Summary of Distresses

LIST OF FIGURES

Figure		Page
1	Typical Wheel Configurations of a Main Leg of Aircraft Landing Gear	5
2	Prescriptive Specification	14
3	End-Result Specification	15
4	Quality Assurance Specification	15
5	The PSR Rating Scale	21
6	Pavement Condition Rating Systems	22
7	The PCI Rating System	23
8	The PASER System	24
9	Alligator or Fatigue Cracking	25
10	Bleeding	25
11	Block Cracking	26
12	Corrugation	26
13	Depression	27
14	Jet Blast Erosion	27
15	Joint Reflection Cracking from PCC	28
16	Longitudinal and Transverse Cracking	28
17	Oil Spillage	29
18	Patching and Utility Cut	29
19	Polished Aggregate	30
20	Raveling	30
21	Rutting	31
22	Shoving of Asphalt Pavement by PCC	31
23	Slippage Cracking	32

24	Swell Distress	32
25	Weathering	33
26	States Included in Project	36
27	Columbus Airport Runway 06/24 PCI Ratings	45
28	Waukegan National Airport Runway 14/32 PCI Ratings	48
29	Edgar County Airport Runway 18/36 PCI Ratings	48
30	Bolingbrook's Clow Airport Runway 18/36 PCI Ratings	49
31	DuPage Airport Runway 10/28 PCI Ratings	50
32	Chicago Executive Airport Runway 16/34 PCI Ratings	50
33	Anderson Municipal Airport Taxiway A PCI Ratings	51
34	Columbus Municipal Airport Taxiway D PCI Ratings	52
35	Cheboygan County Airport Runway 17/35 PCI Ratings	53
36	Houghton County Airport Runway 07/25 PCI Ratings	54
37	Kirsch Memorial Airport Runway 06/24 PCI Ratings	55
38	Marlette Township Airport Runway 01/19 PCI Ratings	55
39	Oakland County Airport Runway 18/36 PCI Ratings	56
40	St. Clair County Airport Runway 10/28 PCI Ratings	57
41	Prairie du Chien Municipal Airport Runway 11/29 PCI Ratings	58
42	Fort Atkinson Municipal Airport Runway 03/21 PCI Ratings	59
43	Crandon Municipal Airport Runway 11/29 PCI Ratings	59
44	Clintonville Municipal Airport Runway 04/22 PCI Ratings	60
45	Amery Municipal Airport Runway 18/36 PCI Ratings	61
46	Baraboo-Wisconsin Dells Regional Apron PCI Ratings	62
47	Bloyer Field Apron and Taxiway A PCI Ratings	62
48	Cumberland Municipal Airport Apron and Taxiway E PCI Ratings	63

49	East Troy Municipal Airport Runway 08/26 PCI Ratings	64
50	East Troy Municipal Airport Taxiway B PCI Ratings	64
51	Fond Du Lac County Airport Apron PCI Ratings	65
52	Park Falls Municipal Airport Runway 18/36 PCI Ratings	66
53	Plot of PCI Ratings by Age	78

LIST OF TABLES

Table		Page
1	Design Inputs for Highways and Airports	1
2	Asphalt Institute Data for Truck Loading Computation	4
3	Coarse Aggregate Requirements	7
4	Fine Aggregate Requirements	8
5	Performance-Related Specification	17
6	List of Airport Projects Evaluated	37
7	Project PCI Ratings Summary Complete	40
8	Coarse Aggregate Requirements	68
9	Fine Aggregate Requirements	69
10	Analysis of Variance	78
11	Summary of Projects Based on Type of Distress Deduct	81

LIST OF SYMBOLS AND ACRONYMS

G_{mb}	Bulk specific gravity
G_{mm}	Maximum specific gravity
N_{design}	Number of laboratory compaction design gyrations
T_c	Critical temperature
V_a	Laboratory compacted air voids
V_{be}	Volume of effective binder
AASHO	American Association of State Highway Officials
AC	Advisory Circular
ABY	Albany Airport
ADIP	Airport Data and Information Portal
AHH	Amery Municipal Airport
AI	Asphalt Institute
AID	Anderson Municipal Airport
AIP	Airport Improvement Program
ANOVA	Analysis of variance
APA	Asphalt Pavement Analyzer
APTech	Applied Pavement Technology
AQC	Acceptance quality characteristics
ASTM	American Society of Testing and Materials
ATRD	Airport Technology Research & Development
BAK	Columbus Municipal Airport
BMD	Balanced mix design
CDF	Cumulative damage factor
CLI	Clintonville Municipal Airport
CMX	Houghton County Memorial Airport
CSG	Columbus Airport
DLL	Baraboo-Wisconsin Dells Regional Airport
DOT	Department of Transportation
DPA	DuPage Airport
CSG	Columbus Airport
ESAL	Equivalent single axle loads
FAA	Federal Aviation Administration
FDR	Full-depth reclamation
FEP	Fundamental Engineering Property
FHWA	Federal Highway Administration
FLD	Fond du Lac County Airport
FOD	Foreign object debris
GDOT	Georgia Department of Transportation
Gpsy	Gallons per square yard
HQ AFCEC	Air Force Civil Engineer Center
HMA	Hot mix asphalt
HWTT	Hamburg Wheel Tracking Test
ILLDOT	Illinois Department of Transportation
INDOT	Indiana Department of Transportation

IRS	Kirsch Memorial Airport
JMF	Job mix formula
L&T	Longitudinal and transverse
M-E	Mechanistic-empirical
MDOT	Michigan Department of Transportation
MEPDG	Mechanistic-Empirical Pavement Design Guide
MTV	Material transfer vehicle
NAVFAC	Naval Facilities Engineering Command
NASA	National Aeronautics and Space Administration
NCAT	National Center for Asphalt Technology
NMAS	Nominal maximum aggregate size
OPC	Operational performance characteristic
PASER	Pavement Surface Evaluation Rating
PCC	Portland cement concrete
PCI	Pavement condition index
PCN	Pavement classification number
PFK	Park Falls Municipal Airport
PG	Performance graded
PHN	St. Clair County Airport
PRG	Edgar County Airport
PRS	Performance-related specification
PSI	Present Serviceability Index
PSR	Present Serviceability Rating
PTK	Oakland County International Airport
PWK	Chicago Executive Airport
PWL	Percent within limits
QA	Quality assurance
QC	Quality control
QRSS	Quality-Related Specification Software
RAP	Reclaimed asphalt pavement
SB	Styrene-butadiene
SBS	Styrene-butadiene-styrene
SHA	State Highway Agency
SLH	Cheboygan County Airport
SMA	Stone matrix asphalt
TMD	Theoretical maximum density
TSR	Tensile strength ratio
UGN	Waukegan National Airport
UFGS	Unified Facilities Guide Specifications
USACE	U.S. Army Corp of Engineers
VMA	Voids in mineral aggregate

EXECUTIVE SUMMARY

The Federal Aviation Administration (FAA) Reauthorization Act of 2018, Section 136, requires the FAA to allow the use of state highway specifications for airfield pavement construction at non-primary airports serving aircraft with a gross weight of less than 60,000 lb. This can occur when it is requested by the state, safety will not be negatively impacted, and the life of the pavement will not be shorter than if constructed using FAA specifications. While this is relatively new legislation, the FAA has permitted the use of state highway specifications for the construction of airports (under certain conditions) since 1977.

There are significant differences in loads, tire pressures, and types of loading between highways and airports, and highway specifications were not developed considering those differences. Therefore, the FAA initiated this project to evaluate the performance of previously constructed airport pavements that used highway specifications and to compare their performance to those constructed using FAA specifications. Consequently, the purpose of this study was to provide the FAA with data to determine if state highway materials and construction requirements can perform satisfactorily at non-primary, public-use airports serving aircraft less than 60,000-lb gross weight.

This project had two primary objectives. One was to evaluate and monitor the in-service performance of airport pavements constructed following state highway specifications for aircraft with a gross weight less than 60,000 lb. The other was to identify differences in material requirements in state highway specifications versus FAA standard specifications for flexible pavement materials. To accomplish these objectives, the research team conducted a literature review to provide background and additional insight into the study and collected the following documentation (if available): construction reports used for construction (including full plans and specifications), pavement performance data, and aircraft traffic used for pavement thickness design. Based on this information, the data were analyzed, and a final report prepared.

To assess the overall performance of each airfield and determine if there was a relationship between design, specifications, construction, and overall performance, records (when available) were reviewed for each of the projects. A summary of each project was compiled by state. During this evaluation, performance data and construction information were obtained from 40 projects from five states (Georgia, Illinois, Indiana, Michigan, and Wisconsin). Of those 40 projects, 19 used state highway specifications, whereas 21 used traditional FAA specifications. Pavement condition index (PCI) ratings obtained at different times following construction were then compiled and summarized for each of the projects as a function of age (years after reconstruction/rehabilitation).

Because of the differences between highway and airport pavements, construction requirements for airport pavement projects can be quite different than those of highway pavement projects. To identify significant differences between the two types of specifications, state asphalt pavement specifications (which were used for the airfield projects documented in this report) and FAA asphalt pavement specifications were compared. During the review, it was noted that many of the state specifications used for airport projects are not necessarily true highway specifications. Of the five states evaluated, three had separate aviation specifications that were used for airport construction. In these instances, the state aviation specifications were compared to the FAA specifications. In general, state aviation specifications were found to be somewhat more restrictive

than their highway specifications, whereas in one instance (Wisconsin), they were very similar to the FAA P-401 specifications. The specification comparisons focused on the following: aggregate characteristics, asphalt binder grade, mix design criteria, quality control requirements, acceptance requirements, and construction requirements. More details on each specification and comparisons are shown in Section 5 of this report.

Based on the information compiled during this project, the following conclusions were drawn:

- Based on the PCI ratings, the performance of airport asphalt pavements constructed using state specifications is statistically equivalent to pavements constructed using FAA specifications. Performance trends showed a PCI rating of approximately 60 at year 14 for both types of specifications.
- Climate-based distresses were the predominant mode of distress for both FAA and state highway and aviation specification projects. Longitudinal and transverse cracking as well as weathering were found to be the most prevalent types of distresses, which is consistent with previously reported findings for airport pavements: Non-load associated distresses are the predominant distresses observed on airfield pavements.
- The number of load-related distresses were relatively minor. Only 8 of the 40 projects evaluated had load-related distresses. Of those projects, five used state aviation specifications, and three used FAA specifications.
- Of the six projects with alligator (fatigue) cracking, five used state aviation specifications, which could be an indicator that the state aviation specification mixtures may have reduced fatigue resistance. This observation should be further validated with additional field work. If confirmed, additional laboratory experimental work and modeling would be warranted.
- Only two projects experienced rutting distresses (low severity), and both used FAA specifications. The lack of rutting on state highway and aviation specification projects may indicate that using state specifications does not seem to increase the risk of rutting. However, more results with similar loading and environmental conditions from both FAA and state specification projects are needed to provide a generalized conclusion.
- Although volumetric mix design requirements in the FAA specifications are more focused on improving the cracking and rutting resistance than state specifications, both types of projects experienced similar levels of distresses.
- The mat density requirements for state specifications are similar to those in the FAA specification; however, the FAA has a strict method specification for joint construction plus a joint density requirement. Most of the state highway and aviation specifications examined did not include a joint density requirement. Although it was expected that the FAA joint specification would reduce distresses associated with longitudinal joints, the available data do not support that conclusion at this time. Given the predominance of longitudinal cracking distresses on airports, additional studies of this issue are warranted.

1. INTRODUCTION

Flexible pavements consisting of asphalt mixtures and granular bases are commonly used on airfields and highways. Although there are many similarities between these two pavement types, the loading characteristics are quite different between airport and highway pavements, both in the number of loads and their magnitude. An airport pavement typically experiences no more than a few hundred load repetitions each day, as compared with 50,000 load repetitions or more on major highways (Huang, 2004). However, the magnitude of wheel loads and tire pressures is much greater in the case of airport pavements (up to 30 tons and 250 psi, respectively) when compared with highway pavements (6.5 tons and 100 psi). In addition, gear configurations of aircrafts can affect how the load and pressure are applied to a pavement. For instance, aircraft with gross weights up to 60,000 lb will have a single- or dual-wheel nose gear and a combination of single and dual main gear at different longitudinal and transverse spacing (AC 150/5320-6E). However, for trucks, single, dual, and tandem axles are located along the same axis. According to the Gulfstream G450 Maintenance Manual (2013), main gear tires can have inflation pressures up to 150 psi for aircraft with gross weights up to 60,000 lb, whereas the nose tire inflation can be up to 80 psi.

These differences in loading have an impact on both the manner that airfield pavements are designed and how they are constructed. Table 1 compares the design inputs for highway versus airport pavements, which typically result in airport pavements that are generally thicker than highway pavements.

Table 1. Design Inputs for Highways and Airports

Characteristic	Highway	Airport
Typical design load	9,000 lb/tire	Up to 73,000 lb/tire
Traffic volume	1,000–2,000 trucks/day	20,000 to 40,000 applications over lifetime
Tire pressure	100 psi	Up to 250 psi
Traffic location	Near pavement edge	Pavement center with significant wander compared to highway traffic

Although many aspects of highway and airport pavement construction are similar, the functions and requirements of the pavements necessitate differences in some of the materials that are used and how they are typically specified and constructed. Certain pavement distresses are more critical in one pavement type than the other. Although raveling in a highway pavement is a relatively minor concern, which may lead to cracked windshields and a loss of ride quality, raveling in an airport pavement can create foreign object debris (FOD). FOD can lead to the loss of a \$1,000,000 aircraft engine and a potential loss of life. Conversely, rutting on a high-speed interstate highway (or an airport runway) may pose a greater threat to public safety because of hydroplaning than rutting on an airport taxiway or a low-volume, low-speed highway pavement.

Specifications used on airport pavements must be more focused on the specific functions of the pavement and types of distresses that are typically encountered. Environment-related distresses such as weathering, raveling, and longitudinal and transverse cracking are the most common distresses encountered on airport pavements (Buncher & Boyer, 2005). As a result, FAA asphalt

specifications tend to focus on requirements to minimize those distresses. This includes requirements for higher quality aggregates, a lower design air void content, and increased pavement mat and joint density requirements. Conversely, construction specifications for highway pavements tend to focus more on addressing load-related distresses, such as rutting and fatigue cracking, and typically have higher mix design air void requirements. Pavement density requirements are generally similar for highway and airfield pavements, except for joint density. This is because not all state highway or aviation specifications contain joint density requirements, nor are the joint density requirements as high, in most cases.

The Federal Aviation Administration Reauthorization Act of 2018, Section 136 requires the Federal Aviation Administration (FAA) to allow the use of state highway specifications for airfield pavement construction at non-primary airports serving aircraft that do not exceed 60,000 lb if: (1) it is requested by the state, (2) safety will not be negatively impacted, and (3) the life of the pavement will not be shorter than if constructed using FAA standards. While this most current legislation became effective in 2018, the FAA's history of allowing state highway specifications goes as far back as 1977, with the issuance of Advisory Circular (AC) 150/5100-13, *Development of State Standards for General Aviation Airports* (FAA, 1977). Among other items, the AC provided guidance on using state highway specifications on pavements that are not on an air carrier airport. However, the AC provided only the following guidance regarding the approval of highway specifications:

State Highway Specifications. These specifications have been developed primarily for use in construction of roads and should be adopted only if the performance record under equivalent loadings and exposure has been satisfactory. For pavements which will receive substantial use by aircraft exceeding 60,000 lb gross weight or with tire pressures greater than 100 psi, FAA standards should be adopted since they have been used successfully for many years on airports serving this type of aircraft and have been validated by extensive research.

In 2000, U.S. Code 47114(d)(5) was amended, which allowed state highway specifications to be used at non-primary airports with runways of 5,000 ft or shorter, serving aircraft not exceeding 60,000-lb gross weight if safety will not be negatively impacted and the life of the pavement will not be shorter than if constructed using FAA standards. Since 2000, there have been several modifications to FAA documents providing guidance on the use and approval of state highway specifications, culminating with the Reauthorization Act of 2018.

Because there are differences in loads, tire pressures, and types of loading between highways and airports, and because highway specifications for asphalt pavements were not developed considering those differences, there is a need for the FAA to evaluate the in-service performance of airport pavements previously constructed using highway specifications. The intent would be to compare their performance to that of airport pavements constructed using FAA standard specifications. Consequently, the purpose of this study was to provide the FAA with actual in-service performance data to determine if state highway asphalt materials and construction requirements can perform satisfactorily at non-primary public-use airports serving aircraft less than 60,000-lb gross weight.

2. OBJECTIVE AND SCOPE

The primary objectives of this project are to: (a) evaluate and monitor the in-service performance of airport pavements constructed following state highway specifications for aircraft less than 60,000 lb; and (b) identify differences in material requirements in state highway specifications versus FAA standard specifications for flexible pavement materials.

To accomplish the objectives of this study, the research team conducted a literature review to provide background and additional insight to the study. They collected construction reports, including full plans and specifications used for construction, pavement performance data, and aircraft traffic used for pavement thickness design. They also performed data analyses with discussions and prepared this final report.

3. LITERATURE REVIEW

3.1 TRAFFIC LOADING ANALYSIS (HIGHWAY VS AIRPORTS)

The process for estimating loading applications for airfield and highway pavements include the following basic steps:

- Estimate expected initial year traffic volume.
- Estimate expected annual traffic growth rate.
- Estimate traffic stream composition.
- Compute traffic loading.
- Estimate directional split of design traffic loads (highways only).
- Estimate design lane traffic loads (highways only).
- Estimate design traffic loading for different functional areas (airfields only).

Information concerning the first two steps is usually obtained from traffic surveys and forecasts based on historical trends or prediction using transportation models for highway pavements. For airfield pavements, such information is usually obtained from the planning forecast of the airport authority and is based on number of departures (Chen, 2003).

3.1.1 Traffic Stream Composition

For highways, the number of different types of vehicles, such as cars, buses, single-unit trucks, and multiple-unit trucks expected to use the highway, must be estimated. A vehicle-type distribution can be obtained from classification counts made on a similar highway type within the same region or from general data compiled by highway agencies. Table 2 shows an example of vehicle type distribution used in the pavement design methodology developed by the Asphalt Institute (AI) for highway pavements (Asphalt Institute, 1983).

Table 2. Asphalt Institute Data for Truck Loading Computation (AI, 1983)

Truck Class		Average Trucks				
		Interstate Rural	Other Rural	All Rural	All Urban	All System
(a) Average Distribution on Different Classes of Highways (U.S.)						
Single-unit trucks	2 axle, 4 tire	39	58	47	61	49
	2 axle, 6 tire	10	11	10	13	11
	3 axle or more	2	4	2	3	3
	All Single-Unit	51	73	59	77	63
Multiple-unit trucks	3 axle	1	1	1	1	1
	4 axle	5	3	4	4	4
	5 axle or more	43	23	36	18	32
	All multiple-unit	49	27	41	23	37
All trucks		100	100	100	100	100
(b) Average Truck Factors (TF) for Different Classes of Highways and Vehicles (U.S.)						
Single-unit trucks	2 axle, 4 tire	0.02	0.02	0.03	0.03	0.02
	2 axle, 6 tire	0.19	0.21	0.20	0.26	0.21
	3 axle or more	0.56	0.73	0.67	1.03	0.73
	All single-unit	0.07	0.07	0.07	0.09	0.07
Multiple-unit trucks	3 axle	0.51	0.47	0.48	0.47	0.48
	4 axle	0.62	0.83	0.70	0.89	0.73
	5 axle or more	0.94	0.98	0.95	1.02	0.95
	All multiple-unit	0.93	0.97	0.94	1.00	0.95
All trucks		0.49	0.31	0.42	0.30	0.40

For airfields, the weight of an aircraft is transmitted to the pavement through its nose gear and main landing gears (Chen, 2003). Figure 1 shows the wheel configurations commonly found on the landing gear of typical commercial aircraft. Because the gross weight and exact arrangement of wheels differ among different aircraft, it is necessary to identify the types of aircraft, landing gear details, and their respective frequencies of arrival for the purpose of pavement design.

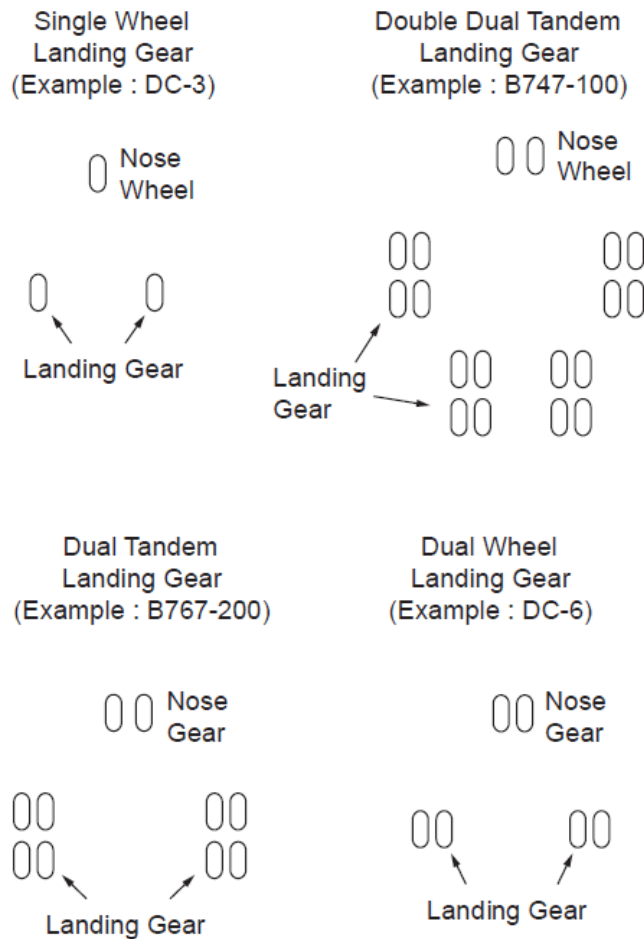

Figure 1. Typical Wheel Configurations of a Main Leg of Aircraft Landing Gear (FAA, 2009)

3.1.2 Load Repetitions

In the most commonly used pavement design methodology for highways, the 1993 AASHTO Design Guide, loads for all vehicle types are normalized to equivalent single axle loads (ESALs) (AASHTO, 1993). New pavement design methodologies account for the entire traffic distribution and load spectrum to estimate damage more accurately over the lifespan of the pavement. For airfields, pavement design is generally based on the maximum gross weight of the aircraft. It is also common to assume that 95% of the gross weight is carried by the main landing gear and 5% by the nose gear. The FAA recommends using the maximum anticipated takeoff weight, which provides some degree of conservatism in the design. This allows for changes in operational use and forecasted traffic. The conservatism is offset somewhat by ignoring arriving traffic (FAA, 2009).

Tire pressure varies depending on gear configuration, gross weight, and tire size. Tire pressure has a much greater influence on strain levels in the asphalt surface layer than at the subgrade. Tire pressures more than 221 psi (1.5 MPa) may be safely carried if the asphalt surface course and base course meet the minimum design requirements. Small aircraft have tire pressures similar to cars

and trucks, while larger aircraft have tire pressures many times greater than smaller aircraft or truck tires. Although traffic on highways is typically channelized in the wheel-paths, airfield traffic patterns can vary from channelized moving (taxiways) to channelized static (end of runways or taxiways) to evenly distributed and random (aprons) to occasional (runway edges) to almost no traffic (shoulders and blast pads) (Chen, 2003).

3.1.3 Annual Departures and Traffic Cycles

Current FAA airport pavement design methodology considers only departures and ignores arrival traffic when determining the number of aircraft passes. This is because aircraft typically arrive at a significantly lower gross weight than at takeoff because of fuel consumption. During touchdown impact, lift on the wings reduces the dynamic vertical force that is transmitted to the pavement through the landing gears (FAA, 2016).

In airfield pavement design, fatigue failure is expressed in terms of a cumulative damage factor (CDF) using Miner's Rule. CDF represents the amount of structural fatigue life of a pavement that has been consumed (FAA, 2016). In mechanistic-empirical (M-E) pavement design for highways, CDF is also used for fatigue and permanent deformation failure. The main difference between CDF values on highways and airfields is the consideration of wheel wander. For airfields, CDF is calculated for each 10-in.-wide strip along the pavement over a total width of 820 in. Pass-to-coverage ratio is computed for each strip, assuming that traffic is normally distributed laterally and that 75 percent of passes fall within a "wander width" of 70 in. For highways, wheel wander is not considered in empirical methods, but a small wheel path is sometimes considered in M-E approaches.

3.2 SPECIFICATIONS FOR ASPHALT HIGHWAY AND AIRPORT PAVEMENTS

Construction requirements for airport pavement projects can be quite different than those of highway pavement projects. To identify significant differences, a comparison of highway asphalt pavement specifications was made with airfield pavement specifications. Because agency specifications can differ for both highways and airfields, a comparison was made of two current highway agency asphalt specifications, the Illinois Department of Transportation (ILDOT) and the Georgia Department of Transportation (GDOT) and two current airport agency asphalt specifications, specifically AC 150/5370-10H, Item P-401 (FAA, 2018) and the Unified Facilities Guide Specifications Section 32 12 15.13 (UFGS, 2020), which are used for the construction of U.S. military airfields.

The FAA's P-401 specification requirements are used for the surface course of airfield flexible pavements subjected to aircraft with gross weights greater than 30,000 lb. For airfield pavement projects at non-primary airports, serving aircraft less than 60,000 lb, state highway specifications may be used in states that have requested and received FAA approval to do so. For this comparison, the FAA requirements will be based on loadings less than 60,000 lb.

3.2.1 Materials

3.2.1.1 Aggregates

Tables 3 and 4 provide a summary of coarse and fine aggregate requirements for the various specifications.

Table 3. Coarse Aggregate Requirements

Material Test	FAA	UFGS	GDOT	ILDOT
Resistance to abrasion (% maximum loss)	40	40	40	40
Soundness (% maximum loss)	12 (sodium); 18 (magnesium)	12 (sodium); 18 (magnesium)	15 (magnesium)	15 (sodium)
Clay lumps & friable particles (% maximum)	0.3	0.3	NA	See below
Fractured faces	50% with at least two fractured faces and 65% with at least one fractured face	Minimum 75% two or more fractured faces	Minimum 85% one or more fractured faces	NA
Flat & elongated (%)	≤ 8 (5:1 ratio)	≤ 20 (3:1 ratio)	≤ 10 (5:1 ratio)	Limits in AASHTO M 325 (SMA only)
Bulk density of slag	≥ 70 pcf	≥ 75 pcf	NA	NA
Clay lumps	NA	NA	NA	0.25
Shale	NA	NA	NA	1.0
Coal & lignite	NA	NA	NA	0.25
Soft & unsound particles %	NA	NA	NA	4.0
Other deleterious %	NA	NA	2.0	4.0
Total deleterious	NA	NA	NA	5.0
Mica schist maximum %	NA	NA	10	NA
Glassy particles (slag) maximum %	NA	NA	30	NA

NA–Not applicable; not specified

pcf–Pounds per cubic ft

SMA–Stone matrix asphalt

Table 4. Fine Aggregate Requirements

Material Test	FAA	UFGS	GDOT	ILDOT
Liquid limit	25 maximum	NA	NA	NA
Plasticity index	4 maximum	NA	NA	NA
Soundness (maximum % loss)	10 (sodium); 15 (magnesium)	NA	NA	10 (sodium)
Clay lumps & friable particles (maximum %)	0.3	0.3	NA	NA
Sand equivalent (Minimum %)	45	45	Limestones ≥ 28 Granites ≥ 40 Natural sand ≥ 20 Blended sand ≥ 25	NA
Maximum sand content	15%	15%	NA	NA
Fine aggregate angularity	NA	>45%	NA	NA
Organic impurities check	NA	NA	NA	Yes
Shale	NA	NA	NA	3.0
Clay lumps	NA	NA	NA	1.0
Coal, lignite, and shells	NA	NA	NA	1.0
Conglomerate	NA	NA	NA	3.0
Mica (maximum %)	NA	NA	35	NA

In general, the aggregate requirements are comparable. UFGS requirements are slightly more stringent regarding fractured faces, primarily due to loading and tire pressures of military aircraft used on those facilities. One area in which state highway agency specifications may be more robust is with respect to some of the more localized requirements. For example, the ILDOT coarse aggregate specification limits shale to 1.0%, whereas the FAA specification does not address shale. This is likely due to the ILDOT having experienced previous problems with excess shale in that region, an issue with which the FAA is unfamiliar.

3.2.1.2 Asphalt Binder

3.2.1.2.1 Federal Aviation Administration

A performance graded (PG) binder meeting the requirements of ASTM D6084 is required with the additional requirement of elastic recovery. Prior to grade bumping, the PG grade must be consistent with the applicable state DOT requirements. Grade bumping is required based on aircraft gross weight and pavement areas with slow or stationary aircraft.

3.2.1.2.2 Unified Facilities Guide Specifications

The same PG binder grade is recommended as the base grade for the project as is used by the state highway department in the area (e.g., the grade typically specified in that location for dense-graded mixes on highways with design ESALs less than 10 million). PG binders with a low critical temperature higher than PG XX-22 (for example, PG XX-16 or PG XX-10) are not permitted unless the engineer has had successful experience with them. High-temperature grade bumping is

recommended based on tire pressures. Also, the designer may use penetration-graded binder in lieu of the PG grade on projects in countries outside of the U.S.

3.2.1.2.3 Georgia Department of Transportation

PG 67-22 is the standard grade for all mixtures. For mixtures containing reclaimed asphalt pavement (RAP), the engineer determines the PG grade. PG 76-22 is required as specified by the Design Engineer. The PG 76-22 can use only styrene-butadiene-styrene (SBS) or styrene-butadiene (SB) as a modifier with neat asphalt to produce the PG 76-22. Air blown asphalts are not permitted.

3.2.1.2.4 Illinois Department of Transportation:

- The asphalt binder must be an SBS modified PG 76-28 when SMA is used on a full-depth asphalt pavement and an SBS modified PG 76-22 when used as an overlay. Elastomers must be added to the base asphalt binder to achieve the specified PG and must be either a styrene-butadiene di-block or tri-block copolymer, without oil extension, or a styrene-butadiene rubber. Air-blown asphalts, acid modification, and other modifiers are not allowed. Asphalt modification at hot-mix asphalt plants is not allowed.
- *Differences:* In general, the binder requirements are all very similar. The main differences are how state agencies specify when to “bump” the binder grade on a project.

3.2.2 Mix Design

3.2.2.1 Federal Aviation Administration

The laboratory used to develop the job mix formula (JMF) must possess a current certificate of accreditation, listing ASTM D3666 from a national accrediting authority. The asphalt mixture must be designed using procedures contained in the AI’s MS-2 Mix Design Manual, 7th Edition. The project designer selects the method for mix design, either Marshall Method (ASTM D6926) or Gyratory Method (ASTM D6925). 50 blows or gyrations are specified for airports serving aircraft 60,000 lb or less. Design criteria include the following:

- Three nominal maximum aggregate size (NMAS) gradations: 19.0 mm, 12.5 mm, or 9.5 mm (9.5 mm allowed for leveling only)
- Design air voids set to 3.5%
- Minimum voids in the mineral aggregate (VMA) requirements: 14.0% for 19.0 mm, 15.0% for 12.5 mm, 16.0% for 9.5 mm
- TSR \geq 80%
- RAP either excluded by the project designer or used with binder grade adjustments (0%–20%: no adjustment; >20%–30%: one grade softer)

- Asphalt Pavement Analyzer (APA) (or Hamburg) required on projects with aircraft >60,000 lb

3.2.2.2 Unified Facilities Guide Specifications

The project designer selects the method for mix design. Either 75 blow Marshall hand-held hammer compaction or 75 gyration Superpave gyratory compaction is permitted for all pavements designed for tire pressures of 100 psi or higher. Either 50 blow Marshall hand-held hammer compaction or 50 gyration Superpave gyratory compaction is permitted for all shoulder pavements and pavements designed for tire pressures less than 100 psi. Asphalt mixtures must be designed in accordance with the AI's MS-2. Samples are prepared at various asphalt contents and compacted in accordance with ASTM D6925. Design criteria include:

- Three NMAS gradations: 19.0 mm, 12.5 mm, and 9.5 mm
- Design air voids equal to 4.0%
- Minimum VMA: 19.0 mm–13.0%, 12.5 mm–14.0%, 9.5 mm–15.0%
- TSR \geq 75%
- RAP either excluded by the project designer or used with binder grade adjustments (0%–20%: no adjustment; >20%–30%: one grade softer)

3.2.2.3 Georgia Department of Transportation

The Superpave design method is used following AASHTO TP 4 and PP 2 (updated to T 312 and R 30, respectively). Designs must be performed by qualified and approved laboratories and technicians. One-percent hydrated lime is required in all mixtures. Local sand content is limited. Design criteria include:

- Four NMAS gradations: 25.0 mm, 19.0 mm, 12.5 mm, 9.5 mm
- N_{design} levels of 50, 75, 100, and 125, respective of the NMAS gradations
- Design air voids equal to 4.0%
- Minimum VMA: 25.0 mm–12.0%, 19.0 mm–13.0%, 12.5 mm–14.0%, 9.5 mm–15.0%
- APA rutting: N_{design} 75–6 mm maximum, N_{design} 100/125–5 mm maximum
- TSR 80% minimum.

3.2.2.4 Illinois Department of Transportation

The Superpave design method is used following modified AASHTO M 323 criteria. Designs must be performed by a qualified laboratory for design. Design criteria requires: two NMAS gradations: 9.5 mm (surface), 19.0 mm (binder); N_{design} levels 50, 70, and 90; design air voids equal to 4.0%;

minimum VMA: 19.0 mm–13.5%, 9.5 mm–15.0%; TSR: 85% minimum; Hamburg rutting: Maximum 0.5 in. at number of passes based on high critical temperature (T_c).

3.2.2.5 Differences

The FAA minimum VMA requirements are higher than the state agency specifications. This coupled with the FAA design air void target of 3.5% results in a higher volume of effective binder (V_{be}) for FAA mixes. For example, comparing a 12.5-mm FAA mix with a 12.5-mm GDOT mix, the minimum V_{be} for an FAA mix is 11.5%, whereas a GDOT mix would have a minimum V_{be} of 10.0%. This difference would likely mean a 0.6%–0.7% lower asphalt content by mass for a GDOT mix design. Because asphalt content is closely associated with pavement durability and cracking resistance, this would be expected to have a significant impact on the serviceability and life of the airfield pavement.

3.2.3 Quality Control

3.2.3.1 Federal Aviation Administration

Requires an approved quality control (QC) Program. Minimum testing includes binder content (2/day), extracted aggregate gradation (2/day), moisture content of aggregate and asphalt mixture (1/day), temperatures (4/day), in-place density and smoothness (as necessary), grade measurements, VMA (1/day). Control charts with action and suspension limits must be maintained.

3.2.3.2 Unified Facilities Guide Specifications

Requires an approved QC Program. Standard lot is 1 day or 2,000 tons (whichever is smaller). Minimum testing includes binder content (2/lot), extracted aggregate gradation (2/lot), aggregate specific gravity (1/18,000 tons), fractured faces and fine aggregate angularity (1/18,000 tons), temperature (4/lot), aggregate and mixture moisture content (1/lot), air voids and VMA (4/lot), in-place density and smoothness (as necessary), grade measurements. Control charts with action and suspension limits must be maintained.

3.2.3.3 Georgia Department of Transportation

Requires an approved QC Plan and qualified laboratory and testing personnel. Lot size is 1 day's production, subplot is 500 tons. Minimum testing includes binder content and extracted gradation (1/sublot), mixture temperature (1/sublot), density.

3.2.3.4 Illinois Department of Transportation

Requires an approved Annual QC Plan and QC Addenda. Testing is based on daily production. Minimum testing includes aggregate gradation (1/half-day), binder content (1/half-day), VMA (1/half-day), air voids (1/half-day), maximum specific gravity (1/half-day), density (1/half-mile) with cores or correlated thin lift nuclear gauge. Control limits (including individual tests and moving average of four) are established for gradation, binder content, air voids, and VMA. Relative density limits are also based on N_{design} (9.5 mm, N_{design} = 90: 92.0%–96.0%; 19.0 mm, N_{design} = 90: 93.0%–96.0%).

3.2.3.5 Differences

The FAA and UFGS specifications are generally more detailed on QC requirements than the state agency specifications. GDOT does not require volumetric properties to be tested as part of QC.

3.2.4 Acceptance

3.2.4.1 Federal Aviation Administration

Testing must be performed in an accredited laboratory (ASTM D3666) and performed by qualified personnel. Lot size is one day's production divided into sublots of 400 to 600 tons. Acceptance tests include air voids, in-place asphalt mat and joint density (5-in. cores), grade, and profilograph roughness. Acceptance is based on percent within limits (PWL) formula with upper and lower limits for air voids (2.0% and 5.0%); lower limits for surface course mat density (92.8%), base course mat density (91.8%), and joint density (90.5%); grade, and roughness. PWL of 90% or greater is acceptable. Payment is based on mat density and air voids.

3.2.4.2 Unified Facilities Guide Specifications

Testing must be performed in an accredited laboratory by qualified personnel. The testing frequency is once every 500-ton subplot. The tests performed are laboratory air voids, theoretical maximum density (TMD), in-place density, and surface smoothness by straightedge and profilograph. Acceptance is based on individual pay factors for in-place density and smoothness and mean absolute deviation for laboratory air voids. Mat density target (average of four cores) is 94.0%–96.0% of theoretical maximum density. Joint density target (average of four cores) is > 92.5% of TMD. The lot pay factor is the lowest computed pay factor of laboratory air voids, in-place density, grade, or smoothness.

3.2.4.3 Georgia Department of Transportation

Laboratory testing is performed in an accredited laboratory by qualified personnel. Lot size is 1 day's production. The tests performed are asphalt content, gradation (3/8, No. 4 and No. 8 sieves), in-place air voids, and smoothness. Maximum pavement mean air voids is 7.8% (92.2% G_{mm}). Acceptance is based on Pavement Mean Air Voids (density); pay factors for binder content; 3/8, No.4 and No. 8 sieves; and smoothness index.

3.2.4.4 Illinois Department of Transportation

Must use a qualified laboratory and personnel. Uses verified contractor test data for acceptance. (See QC requirements above).

3.2.4.5 Differences

The acceptance criteria are similar regarding laboratory air voids and in-place density requirements, with the exception that GDOT does not use laboratory air voids for as-constructed acceptance criteria.

3.2.5 Construction

3.2.5.1 Federal Aviation Administration

Includes an option to require a material transfer vehicle (MTV). Tack must be an undiluted emulsified asphalt meeting the requirements of ASTM D3628, with an application rate (residual) of 0.04–0.08 gallons per square yard (gpsy) for milled surfaces. Cold longitudinal joints must be cut back a maximum of 3 in.

3.2.5.2 Unified Facilities Guide Specifications

Requires the use of an MTV. Tack must be an undiluted emulsified asphalt meeting the requirements of ASTM D2397 (Grades SS-1h and CSS-1h are recommended), with an application rate (residual) of 0.03–0.10 gpsy for milled surfaces. Cold longitudinal joints must be cut back a maximum of 3 in.

3.2.5.3 Georgia Department of Transportation

Requires the use of an MTV if there are more than 6,000 vehicles per day and the project length is greater than 3,000 ft. The vertical face of the longitudinal joint must be cleaned and tacked before placing adjoining material. Tack material can be PG 58-22, PG 64-22, PG 67-22 or CRS-2h, or CRS-3. The application rate is determined by the engineer within the range of 0.04–0.06 gpsy. Longitudinal joints must be constructed so that the joint is smooth, well-sealed, and bonded. Joint density is not required.

3.2.5.4 Illinois Department of Transportation

Tack material includes SS-1, SS-1h, SS-1hP, SS1-vh, RS-1, RS-2, CSS-1, CSS-1h, CSS-1hP, CRS-1, CRS-2, HFE-90, or RC-70; and the application rate is 0.05 gpsy residual. A notched wedge longitudinal joint must be used between successive passes of hot-mix asphalt (HMA) binder course that has a difference in elevation of greater than 2 in. (50 mm) between lanes on pavement that is open to traffic.

3.2.5.5 Differences

Primary differences are that the state specifications do not have a requirement to cut back the longitudinal joint and are unclear whether an MTV is required.

3.3 PERFORMANCE-RELATED SPECIFICATIONS

Highway and airfield asphalt pavement construction specifications are fundamentally intended to control the production and placement of pavement materials so they will be able to achieve the desired level of performance. Construction specifications typically require certain materials, inspection, or testing activities. These represent the owner's efforts to convey to the contractor the method of constructing the pavement to ensure satisfactory long-term performance.

Specifications have continually evolved over time, generally becoming more sophisticated and advanced as better materials, construction technologies, and testing methodologies have been

developed. While continually evolving, the intent of construction specifications remains the same—to ensure satisfactory long-term performance. However, current asphalt pavement construction specifications for airfields or highways are still largely based on empirical relationships with performance (NCHRP, 1995). With increased load magnitudes and frequencies, there remains a significant need for performance-related specifications (PRSs) that will more effectively ensure long-term performance.

To better understand PRSs, a basic understanding is needed of the various types of specifications used in the asphalt pavement construction industry currently and historically.

3.3.1 Types of Specifications

Highway and airfield construction specifications generally fall along a spectrum ranging from highly prescriptive method specifications to performance specifications. Along this spectrum, the focus of the specifications ranges from being highly detailed regarding materials and construction/inspection activities (which place significant responsibility for performance of the product on the agency), to those that focus more on the ultimate pavement performance (and shift of the responsibility of that performance to the contractor).

The different types of specifications that are either currently used or have been used in the past are listed below (Transportation Research Board, 2018).

3.3.1.1 Prescriptive Specifications

Prescriptive specifications are also known as materials and methods specifications. They require the contractor to use specific materials, equipment, and construction methodologies to produce and place the material. Each activity is directed and inspected by the agency. With this type of specification, if the contractor follows the prescribed directions and uses the correct materials, the agency will accept the completed work. With prescriptive specifications, the agency is ultimately responsible for the quality and performance of the final product. An example of a prescriptive specification is shown in Figure 2.

<p>330-7.2 Standard Rolling Procedure: When density testing for acceptance is not required, propose an alternative rolling pattern to be approved by the Engineer or use the following standard rolling procedure:</p> <ol style="list-style-type: none">1. Breakdown rolling: Provide two static coverages with a tandem steel-wheeled roller, following as close behind the paver as possible without pick-up, undue displacement, or blistering of the mix.2. Intermediate rolling: Provide five static coverages with a pneumatic-tire roller, following as close behind the breakdown rolling operation as the mix will permit.3. Finish rolling: Provide one static coverage with a tandem steel-wheeled roller, after completing the breakdown rolling and intermediate rolling, but before the surface pavement temperature drops to the extent effective compaction may not be achieved or the rollers begin to damage the pavement.
--

Figure 2. Prescriptive Specification (Florida Department of Transportation [FDOT], 2018)

3.3.1.2 End-Result Specifications

End-result specifications require the contractor to assume the entire responsibility for supplying a product or item of construction (smoothness, for example). The agency establishes certain targets

related to the quality of the final product. It is the contractor's responsibility to determine the optimal method to produce and place that product to meet those requirements. Following the completion of construction, the agency evaluates the product and either accepts or rejects it or applies a pay adjustment based on the proximity of the product to established quality characteristics. These types of specifications shift all the responsibility for the quality of the product to the contractor. However, it also gives the contractor greater flexibility in selecting new materials, techniques, and procedures to improve the quality or economy, or both, of the end product. The risk to both the agency and contractor is that, if the final product is rejected, it could significantly impact both the contractor and the agencies that need the project completed. An example end-result specification is shown in Figure 3.

330-9.4.6.2 Laser Acceptance: For areas of high speed roadways where the design speed is equal to or greater than 55 miles per hour, acceptance testing for pavement smoothness of the friction course (for mainline traffic lanes only) will be based on the Laser Profiler. The pavement smoothness of each lane will be determined by a Laser Profiler furnished and operated by the Department in accordance with 5-549 and a report issued with the Ride Number (RN) reported to one decimal place. If corrections are made, as required following Laser Acceptance, the pavement will not be retested for smoothness using the Laser Profiler.

For this testing, the pavement will be divided into 0.1 mile segments. Partial segments equal to or greater than 0.01 mile will be considered as a 0.1 mile segment. The pavement will be accepted as follows:

1. For segments with a RN greater than or equal to 4.0, the pavement will be accepted at full pay.
2. For segments with a RN less than 4.0, the Engineer will further evaluate the data in 0.01 mile intervals for both wheel paths.

Figure 3. End-Result Specification (FDOT, 2018)

3.3.1.3 Quality Assurance Specifications

End-result specifications are frequently combined in some manner with prescriptive specifications to give the agency additional assurance that the contractor is following reasonable processes and procedures. These types of specifications are termed quality assurance (QA) specifications. Under QA specifications, the contractor is responsible QC, and the agency is responsible for acceptance of the product. Final acceptance of the product is usually based on statistical sampling and measurements of key quality characteristics. QA specifications are typically statistically based. They use methods such as random sampling and lot-by-lot testing, which are then used to determine if the contractor is supplying the product within established limits. An example QA specification is shown in Figure 4.

334-5 Acceptance of the Mixture.

334-5.1 General: The mixture will be accepted at the plant with respect to gradation (P-8 and P-200), asphalt content (Pb), and volumetrics (volumetrics is defined as air voids at Ndesign). The mixture will be accepted on the roadway with respect to density of roadway cores. Acceptance will be on a LOT by LOT basis (for each mix design) based on tests of random samples obtained within each sublot taken at a frequency of one set of samples per sublot. A roadway LOT and a plant production LOT shall be the same. Acceptance of the mixture will be based on Contractor QC test results that have been verified by the Department.

Figure 4. Quality Assurance Specification (FDOT, 2018)

3.3.1.4 Performance Specifications

Performance specifications are a type of QA specification that considers how the finished product should perform over time. Performance specifications can include long- and short-term performance warranties and performance-related or performance-based specifications. Long- and short-term warranties will not be discussed here.

True performance specifications generally use the same fundamental concepts. A methodology (based either on empirical or mechanistic performance tests) is used with a predictive model to estimate the performance of a pavement structure according to two scenarios. The first is the “as-designed” scenario, which assumes that the material perfectly meets all design specifications. The second is the “as-constructed” scenario, in which the asphalt mixture used on the project is sampled and tested, and its properties are used to predict as-constructed performance. Cost models are then used to estimate the cost to the agency of each scenario. The difference between the as-designed and as-constructed life cycle cost is then used as a basis for calculating a pay factor (i.e., a bonus or penalty).

3.3.1.4.1 Performance-Based Specifications

Performance-based specifications use fundamental engineering properties that are mechanistically based (dynamic modulus, cyclic fatigue, stress sweep rutting, etc.) and, therefore, directly related to performance. They can be used with mechanistic models to predict stresses and corresponding distresses based on traffic, environment, underlying materials, and structural conditions. However, it should be noted that fundamental engineering properties can be time consuming and expensive to determine, and the predictive models currently in use have not been thoroughly validated. Consequently, performance-based specifications are considered difficult to implement presently.

3.3.1.4.2 Performance-Related Specifications

PRSs use quality characteristics that have indirect relationships to pavement performance. The quality characteristics could include items such as asphalt content, air voids, APA rutting, in-place density, etc. The agency establishes targets for the measured quality characteristics and then incorporates pay tables based on the modeled performance differences between the as-constructed and the as-designed targets for the quality characteristics.

Although similar, it is important to emphasize the difference between performance-based and PRSs. Performance-based specifications use fundamental engineering properties that can be used in mechanistic models to predict pavement performance. PRSs use easier to measure quality characteristics that have general empirical relationships with pavement performance.

Because of complexities associated with developing “true” performance specifications, a few highway agencies have developed specifications that use traditional QA requirements coupled with index properties from simulative performance tests. This helps to better ensure the desired level of performance. These simple performance tests are typically conducted as part of mix design approval and, in some cases, during production. An example of a PRS is shown in Table 5.

Table 5. Performance-Related Specification (NJDOT, 2014)

Test	Requirement			
	Surface Course		Intermediate Course	
	PG 64-22	PG 76-22	PG 64-22	PG 76-22
APA @ 8,000 loading cycles (AASHTO T 340)	< 7 mm	< 4 mm	< 7 mm	< 4 mm
Overlay tester (New Jersey DOT B-10)	> 150 cycles	> 175 cycles	> 100 cycles	> 125 cycles

Balanced mix design (BMD) is a version of this approach in which empirical tests related to rutting and cracking are used to either develop or optimize a mix design. BMD is defined as an asphalt mix design using performance tests on appropriately conditioned specimens to address multiple modes of distress. These tests take into consideration mix aging, traffic, climate, and location within the pavement structure (West et al., 2018).

3.3.2 Specification Evolution

The practice of contracting for construction of public roads in the United States dates from at least the mid-19th century. At the time, the owner/owner-agent used specifications containing “an exact and minute description of the manner of executing the work in all its details” (Gillespie, 1849). The general purpose of this type of specification (later called a “method” specification) was to communicate to the contractor all necessary details to build the project (materials, methods, etc.). These early specifications were generally developed by evolution (NCHRP, 1976). The success of these early projects depended primarily on the skill and expertise of the engineer. Successful projects generally led to newer specifications aimed at duplicating that success on other projects. This led to empirical tests and requirements for assessing the quality of the materials and construction.

This approach to construction specification development assumed that the owner or the owner’s agent had a good understanding of the relationships between the construction process and the quality of the product. These assumptions were maintained through much of the first half of the 20th century, during which time they provided the basis for the specifications for most highway and airfield construction items.

The move toward statistically oriented, end-result specifications for construction probably began following the construction in 1956 through 1958 of the American Association of State Highway Officials (AASHTO) Road Test. Analysis of test data from that project identified significant variability, beyond what was considered normal (NCHRP, 1976). This realization led to the development and implementation of QA specifications. These better addressed the issues of testing and test variability, sample sizes, lot sizes, methods of estimating the total population, percentage within limits, and pay adjustment factors (NCHRP, 2016).

Over time, QA specifications gained widespread acceptance as an improved method for determining the contractor’s degree of compliance with specification limits. In a relatively short time, the use of QA specifications spread to numerous Departments of Transportation as noted in various surveys conducted by the Federal Highway Administration (FHWA) (NCHRP, 2016).

Research conducted in the area of QA specifications also focused on determining the appropriate quality characteristics to use for the acceptance of asphalt mixtures/in-place pavements. A survey conducted as part of NCHRP Synthesis 346 identified typical quality measures used for asphalt paving mixtures, such as asphalt content, gradation, and in-place density. Other common quality measures included volumetric properties, ride quality, thickness, and moisture content (NCHRP, 2005).

A survey conducted as part of NCHRP Synthesis 492 noted that the majority of State Highway Agencies (SHA) use QA specifications that are supplemented by some type of index-based performance test (NCHRP, 2016). The results of that project also found that a small number of agencies are currently using performance tests as part of standard mixture acceptance. Survey data indicated that the performance-based properties most used and researched include the measurement of stiffness (rutting), thermal cracking, moisture resistance, and fatigue cracking. The most frequently cited reasons for using performance tests in asphalt mixture specifications were to achieve better resistance to rutting, cracking, and other distresses. However, roughly one-third of the SHAs indicated that time and cost were limiting factors in adopting PRSs. They stated that performance tests need to be straightforward, relatively quick, and easy to perform. Another important factor that must be considered is industry buy-in, which would include the cost of the test equipment both to purchase and to perform (NCHRP, 2016).

3.3.3 Performance Specifications for Highway Pavements

Since the early 1990s, FHWA has pursued the concept of using a PRS for the design and construction of both concrete and asphalt pavements. The concept of PRS is to use predictive models and determine pay factors based on the predicted life of the as-built pavement compared to the as-designed pavement.

One of FHWA's early efforts in developing PRS specifications came with the construction of the WesTrack test facility in 1995. WesTrack was a full-scale, accelerated loading facility in which asphalt pavement test sections were subjected to full-size truck loads. The WesTrack project, *Accelerated Field Test of Performance-Related Specifications for Hot-Mix Asphalt Construction*, had two main objectives: (1) to continue the development of PRS specifications for asphalt pavement construction by examining how deviations in materials and construction properties, such as asphalt content and degree of compaction, affect the eventual pavement performance; and (2) to provide an early field verification of the Strategic Highway Research Program Superpave performance prediction models and complete mixture analysis procedures (NCHRP, 2002). The project included test sections built with three experimental variables: asphalt content, air void content, and aggregate gradation. The results, which were summarized in terms of rut depths and percentage of the wheel path areas with fatigue cracking, were used to develop simple empirical relationships for performance prediction to support a PRS.

As a follow-up to the WesTrack project, NCHRP Project 9-22 began in 2000 with the goal of advancing the asphalt pavement PRS software (HMA Spec) developed in the WesTrack project. However, the capabilities of the WesTrack PRS software were too limited for general use across the United States. The project then evaluated the possibility of adapting the Mechanistic-Empirical Pavement Design Guide (MEPDG) software to use as an asphalt pavement PRS. However, this approach was excessively complex and eventually was overtaken by using spreadsheet solutions

for the MEPDG that were originally developed in NCHRP Project 9-19. This final version of the asphalt pavement PRS was named the Quality-Related Specification Software (QRSS). The software uses volumetric and material properties to estimate the dynamic modulus of each asphalt layer and M-E models to predict future distresses. The program compares the as-designed predicted distresses with the as-built predicted distresses to determine the predicted life difference that could be used to reward or penalize contractors for their product (NCHRP, 2016).

There were several follow-up projects to the NCHRP 9-22 project (NCHRP Projects 9-22A and 9-22B). These were conducted to beta test the QRSS software and to look at different specimen configurations for distress model predictions (NCHRP, 2016). Additional work on PRS specifications was also conducted by Caltrans in the early 1990s.

Since those early efforts, there have been a few other projects aimed at advancing performance-related or performance-based specifications. NCHRP Synthesis 492 reported that the current state of the practice reported for asphalt pavement mixture design and acceptance is typically using volumetric properties in conjunction with some type of performance test. It was noted that performance tests such as APA and Hamburg Wheel Tracking Test (HWTT) have been incorporated into many agencies' standard mix design requirements. In some instances, these include production acceptance testing at the option of the engineer (NCHRP, 2016).

There are several examples of this approach. The New Jersey DOT adopted a limited use performance specification for certain specialty asphalt mixtures. The APA (AASHTO T 340) is used to assess rutting resistance, and the Flexural Beam Fatigue Test (AASHTO T 321) and the Overlay Test (Texas DOT TEX 248-F) are used to assess cracking resistance (Transportation Research Board, 2014). The Texas DOT developed a BMD approach using the HWTT and the overlay test to assess the rutting and cracking resistance of asphalt mixtures during design (Zhou et al., 2014). The Louisiana Department of Transportation and Development has also adopted a BMD specification using the HWTT to evaluate rutting, and the semicircular bend test to evaluate intermediate cracking (Cooper et al., 2014).

3.3.4 Performance Specifications/Characteristics for Airport Pavements

In general, very limited work has been conducted in the area of performance specifications for airport pavements.

Rushing and Garg (2017) investigated the use of the APA for its ability to detect the rutting potential of asphalt paving mixtures designed for airfields. Six aggregate combinations, each with six different binders, comprised the mixtures used in this study. The binders included two different base binder grades (PGs), each with two levels of modification. Based on the results of this study, the APA was recommended as a rutting performance test for airport asphalt mixture design. The test was selected based on its ability to differentiate between and rank mixture performance, and its ability to identify improved rutting resistance when modified binders were used in the design mix.

Jamieson et al. (2019) described work conducted in Australia to develop a performance-based specification for stone mastic asphalt mixtures. Much like many of the highway agencies in the

United States, they primarily evaluate performance tests during the mix design stage that are related to rutting, fatigue, durability, and surface texture.

Additional work was done in developing a performance-based specification for airport asphalt surfacing in Australia. The purpose of the specification was to allow asphalt producers to innovate for reduced risk and to provide performance guarantees on the asphalt surface layer(s). The specification focuses on constituent materials, mixture design, mixture production, and construction. In general, the requirements for constituent materials remains unchanged. Mixture design retains the general volumetric requirements. However, the mixture design and binder selection are based on laboratory performance testing of the mixture with only the traditional Marshall properties to be reported. During production, Marshall and volumetric properties are used, and during construction, the focus is on density, thickness, level, smoothness, and surface finish (White, 2017).

3.3.5 Basic Elements and Terminology

Performance specifications consist of terms not always used in a typical construction specification. Those terms include the following (Miller et al., 2009):

- *Acceptance Quality Characteristics (AQC)*: Basic asphalt mixture properties, measured at the time of construction. Potential AQC items include asphalt content, air voids, aggregate gradation, in-place density, pavement smoothness, initial friction, etc.
- *Fundamental Engineering Properties (FEPs)*: More advanced asphalt mixture properties, such as stress-strain and fatigue relationships (e.g., dynamic modulus, creep compliance, cyclic fatigue, stress sweep rutting, etc.) that are fundamentally related to performance and can potentially be measured at the time of construction.
- *Performance Characteristic*: HMA properties measured during the performance life of the pavement. Examples include smoothness, roughness, friction, deflection, rutting, cracking, etc.
- *Operational Performance Characteristics (OPCs)*: Measures of pavement performance from the perspective of the user. OPCs are often subjective and, in very general terms, include safety, comfort, and appearance.

3.4 PAVEMENT DISTRESSES AND PAVEMENT CONDITION EVALUATION (HIGHWAY VS AIRPORT)

The rate at which distresses occur in asphalt pavements depends on the adequacy of the pavement design, the quality of materials and construction, the actual versus designed loading, and environmental conditions. The types of distresses are generally indicators of the causes of deterioration (Garg et al., 2004). Properly identifying the type of distress is also essential in developing the appropriate method of rehabilitation.

3.4.1 Pavement Condition Evaluations

To assess the types and severity of distresses, pavement condition surveys are typically conducted on both highway and airfield pavements. These surveys are a key part of the management of any type of pavement network. They provide valuable information that can be used for pavement performance analysis, which is vital to forecast pavement performance, anticipate maintenance and rehabilitation needs, establish maintenance and rehabilitation priorities, and allocate funding (Timm et al., 2004).

Pavement condition surveys provide an indication of the overall serviceability and physical conditions of a pavement. They are typically based on visual observations by trained staff and measurements of pavement roughness, surface distress, skid resistance, deflection, and other characteristics. Condition ratings may be conducted manually, through automated means, or a combination of the two. The choice of automated or manual depends on an agency's priorities and available resources (Attoh-Okine et al., 2013).

Several different methods are used to collect pavement condition data. The type of data collected varies from agency to agency and by pavement type. However, the most common data collected for flexible and rigid pavements include International Roughness Index, rutting, faulting, cracking, patching, and raveling. The severity and extent of each surface distress are also typically collected in the condition survey (Timm et al., 2004).

To better quantify the condition of a pavement, condition rating systems were developed. Condition ratings are used as a basis for comparing the performance of different pavement sections. Also, most importantly, they help agencies determine the extent and severity of pavement defects, estimate the cost of repair and rehabilitation, and prioritize treatment procedures. They are also used as a basis for budget planning purposes. Condition rating indices may also help diminish political pressures that can often influence the decision-making process (Attoh-Okine et al., 2013).

In the 1950s, pavement condition ratings were conducted by a panel of raters who drove along the pavement and subjectively rated its condition based on a numeric scale or verbal description. This form of rating, developed by AASHO, used a 0–5 scale. It was known as the Present Serviceability Rating (PSR). An example of the PSR rating scale is shown in Figure 5.

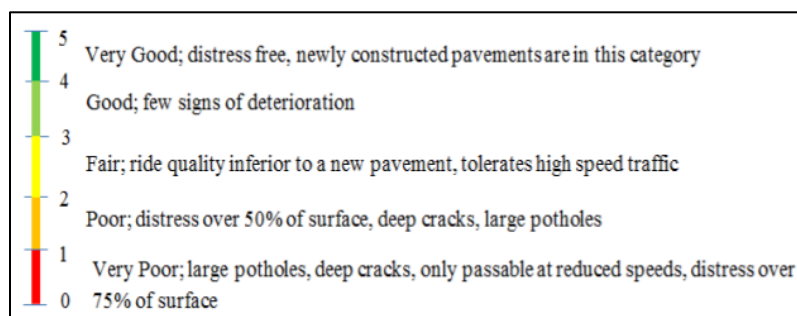

Figure 5. The PSR Rating Scale (Attoh-Okine et al., 2013)

Because the PSR provided limited information with respect to the level and magnitude of distresses, a more objective method of condition rating was developed—the Present Serviceability

Index (PSI). The PSI method was the initial pavement condition index (PCI) used at the AASHO Road Test in 1962. It was developed by using relationships between a panel of raters and roughness measurements made by the AASHO profilometer and the Bureau of Public Roads (BPR) roughometer (Timm et al., 2004). The PSI rating was a function of the variance of slopes measured over a 6-in. wheelbase using the CHLOE profilometer; the mean rut depth, in in; the amount of pavement cracking in ft/1000 ft² of pavement surface; and the amount of patching in ft²/1000 ft² of pavement surface. Under the PSI rating system, a new pavement would generally score between a 4 and 5, and repair is typically required at a PSI between 1.5 and 2.5 (Brown et al., 2009).

In the late 1960s, state highway agencies began developing unique indices to better address pavement issues unique to their location. The U.S. Army Corps of Engineers developed the PCI in 1976, and it is still being used by several agencies today. The scales of the condition indices vary. Some range from 0–5, some range from 1–5, and some range from 0–100 (Attoh-Okine et al., 2013).

Presently, different agencies use different approaches for pavement condition ratings. In general, these approaches can be grouped into two broad categories:

1. Estimated condition rating systems: Based strictly on observed physical conditions of the pavements.
2. Measured condition ratings: Based on observations by trained raters and by physical measurements. Most agencies use the measured condition rating systems because they provide a more objective rating of pavement performance (Attoh-Okine et al., 2013).

Examples of the two rating systems are shown in Figure 6.

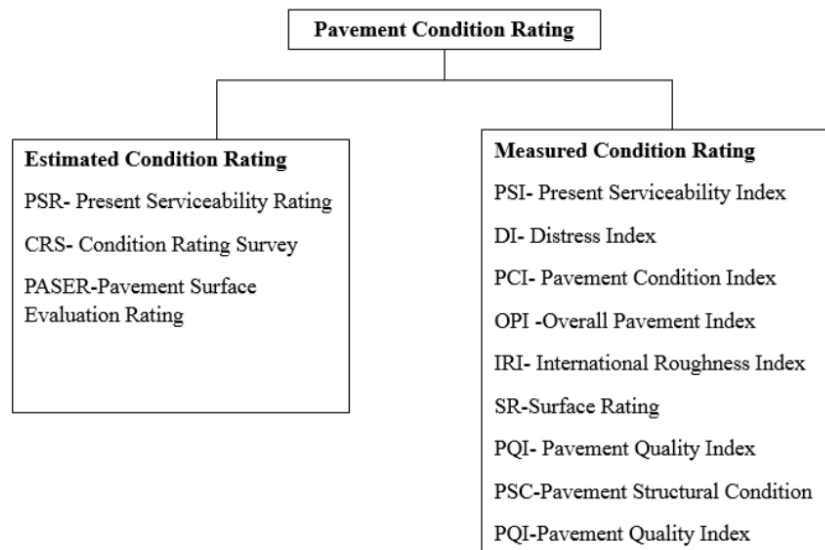

Figure 6. Pavement Condition Rating Systems (Attoh-Okine et al., 2013)

With respect to asphalt airfield pavements, the most common methods of evaluating pavement condition are the PCI and the Pavement Surface Evaluation Rating (PASER), which are briefly described as follows.

- Pavement Condition Index (PCI)*. PCI is a measured condition rating system developed by the U.S. Army Corps of Engineers that has been adopted by the American Public Works Association (APWA) and American Society for Testing and Materials (ASTM) (Attoh-Okine et al., 2013). The PCI is a numerical rating of the pavement condition that ranges from 0–100, with 0 being the worst possible condition and 100 being the best possible condition, as shown in Figure 7. The PCI provides a measure of the condition of the pavement based on the distresses observed on the surface of the pavement. The PCI is determined in accordance with ASTM D5340-12 (2018).
- Standard Test Method for Airport PCI Surveys*. The basic method divides the pavement to be inspected into branches and sections. Each section is further divided into sample units. The number of sample units to be inspected is determined, and each selected sample unit is inspected. The type, severity, and quantity of distresses in that unit are assessed by visual inspection. Each distress identified on the pavement is then assigned deduct values based on the type, severity, and extent. The points are ultimately summed up and deducted from a score of 100 to give the PCI. Sixteen distresses are identified with detailed descriptions to identify high-, medium-, or low-severity distress.

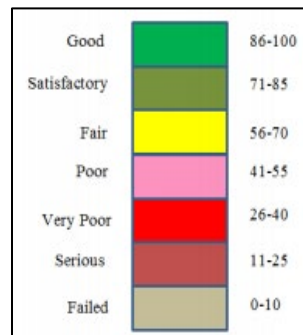

Figure 7. The PCI Rating System

- Pavement Surface Evaluation Rating (PASER)*. PASER is an estimated condition rating system that uses a visual rating of the pavement condition based on a 1–5 scale. The rating system is based on more generalized distress descriptions as opposed to actual measured distresses, as described in ASTM D5340-12 (2018). A manual with photographs and descriptions guides inspectors on choosing the appropriate value on the scale to accurately assess the conditions. Figure 8 shows the PASER ratings, visible distresses, and treatment measures. According to AC 150/5320-17A (FAA, 2014), the PASER system should be used only when it is not possible to complete a more detailed PCI survey as part of a more comprehensive pavement maintenance management program.

Rating system		
Surface rating	Visible distress*	General condition/ treatment measures
5 Excellent	None, or initial thermal cracks, all narrow (less than 1/8")	New pavement less than 5 years old. No maintenance or isolated crack sealing required.
4 Good	Additional thermal cracking. Cracks generally spaced more than 50' apart. Less than 10% of cracks and joints need sealing. Minimal or slight raveling. No distortion. Patches in good condition.	Recent sealcoat or pavement over 5 years old. Seal open cracks or joints and replace sealant where needed.
3 Fair	Moderate raveling. Thermal cracks and joints generally spaced less than 50' apart. Crack sealing or repair of sealant needed on 10%-25% of cracks or joints. Edge cracks along 10% or less of pavement edges. Block crack pattern with cracks 6'-10' apart. Isolated alligator cracking and poor patches. Minor distortion or crack settlement less than 1".	Seal open cracks and joints. Replace failed sealant. Apply new surface treatment or thin overlay. Minor patching and joint repair.
2 Poor	Frequent thermal cracks. Wide cracks and joints with raveling in cracks. Deterioration along more than 25% of cracks. Edge cracks on up to 25% of pavement edges. Block cracks spaced 5' apart or less. Alligator cracking or poor patches cover up to 20% of surface area. Distortion or settlement 1"-2".	Needs significant crack sealing plus patching and repair on up to 25% of pavement surface. Overlay entire area with structural overlay.
1 Failed	Widespread, severe cracking with raveling and deterioration. Alligator cracking and potholes over 20% of the area. Distortion over 2".	Condition may be limiting service. Needs reconstruction.

Figure 8. The PASER System

3.4.2 Airfield Asphalt Pavement Distresses

Listed below are the 16 distress types and descriptions for airfield asphalt pavements from ASTM D5340-12 (2018). The accompanying photographs are from the U.S. Army Corps of Engineers' PAVER™ Distress Identification Manual (Walker et al., 2014).

Alligator or Fatigue Cracking: A series of interconnecting cracks caused by fatigue failure of the asphalt surface under repeated traffic loading. The cracking initiates at the bottom of the asphalt surface (or stabilized base) where tensile stress and strain are highest under a wheel load. The cracks propagate to the surface initially as a series of parallel cracks. After repeated traffic loading, the cracks connect, forming many-sided, sharp-angled pieces that develop a pattern resembling chicken wire or the skin of an alligator. The pieces are less than 2 ft (0.6 m) on the longest side (see Figure 9).



Figure 9. Alligator or Fatigue Cracking

Bleeding: A film of bituminous material on the pavement surface that creates a shiny, glass-like, reflecting surface that usually becomes quite sticky. Bleeding is caused by excessive amounts of asphaltic cement or tars in the mix or low-air void content or both. It occurs when asphalt fills the voids of the mix during hot weather and then expands onto the surface of the pavement. Since the bleeding process is not reversible during cold weather, asphalt or tar will accumulate on the surface (see Figure 10).



Figure 10. Bleeding

Block Cracking: Interconnected cracks that divide the pavement into approximately rectangular pieces. The blocks may range in size from approximately 1 by 1 ft to 10 by 10 ft (0.3 by 0.3 m to 3 by 3 m). Block cracking is caused mainly by shrinkage of the asphalt and daily temperature cycling (that results in daily stress/strain cycling). It is not load associated. The occurrence of block cracking usually indicates that the asphalt has hardened significantly. Block cracking normally

occurs over a large portion of pavement area, but sometimes will occur only in non-traffic areas. This type of distress differs from alligator cracking in that alligator cracks form smaller, many-sided pieces with sharp angles. Also, unlike block cracks, alligator cracks are caused by repeated traffic loadings and are, therefore, located only in traffic areas (that is, wheel paths) (see Figure 11).



Figure 11. Block Cracking

Corrugation: A series of closely spaced ridges and valleys (ripples) occurring at fairly regular intervals (usually less than 5 ft) (1.5 m) along the pavement. The ridges are perpendicular to the traffic direction. Traffic action combined with an unstable pavement surface or base usually causes this type of distress (see Figure 12).

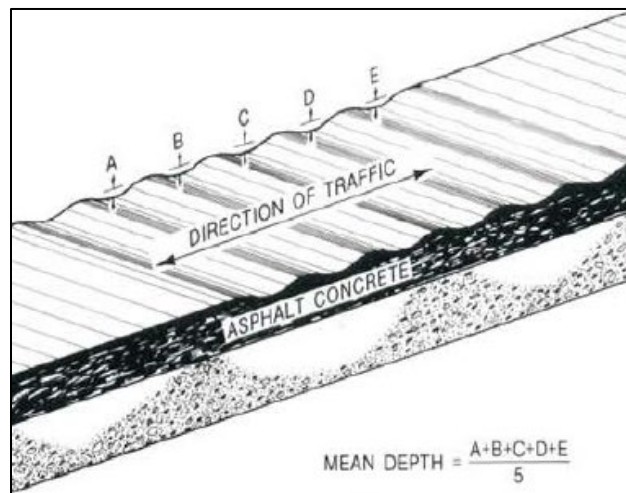

Figure 12. Corrugation

Depression: Localized pavement surface areas having elevations slightly lower than those of the surrounding pavement. In many instances, light depressions are not noticeable until after a rain, when ponding water creates “birdbath” areas, but depressions can also be located without rain

because of stains created by ponding of water. Depressions can be caused by settlement of the foundation soil or can be built during construction. Depressions cause roughness and, when filled with water of sufficient depth, could cause hydroplaning of aircraft (see Figure 13).



Figure 13. Depression

Jet Blast Erosion: Jet-blast erosion causes darkened areas on the pavement surface where the asphalt binder has been burned or carbonized. Localized burned areas may vary in depth up to approximately 1/2 inch (13 mm) (see Figure 14).



Figure 14. Jet Blast Erosion

Joint Reflection Cracking from Portland cement concrete (Longitudinal and Transverse): This distress occurs only on pavements having an asphalt or tar surface over a Portland cement pavement (PCC) slab. This category does not include reflection cracking from any other type of base (i.e., cement stabilized or lime stabilized). Such cracks are listed as longitudinal and transverse cracks. Joint reflection cracking is caused mainly by movement of the PCC slab beneath

the asphalt surface because of thermal and moisture changes; it is not load related. However, traffic loading may cause a breakdown of the asphalt near the crack, resulting in spalling and FOD potential. If the pavement is fragmented along a crack, the crack is said to be spalled. A knowledge of slab dimensions beneath the asphalt surface will help to identify these cracks (see Figure 15).



Figure 15. Joint Reflection Cracking from PCC

Longitudinal and Transverse Cracking (Non-PCC Joint Reflective): Longitudinal cracks are parallel to the pavement's center line or laydown direction. They may be caused by (1) a poorly constructed paving lane joint, (2) shrinkage of the asphalt surface due to low temperatures or hardening of the asphalt, or (3) a reflective crack caused by cracks beneath the surface course, including cracks in PCC slabs (but not at PCC joints). Transverse cracks extend across the pavement at approximately right angles to the pavement's center line or direction of laydown. They may be caused by (2) or (3). These types of cracks are not usually load associated. If the pavement is fragmented along a crack, the crack is said to be spalled (see Figure 16).



Figure 16. Longitudinal and Transverse Cracking

Oil Spillage: The deterioration or softening of the pavement surface caused by the spilling of oil, fuel, or other solvents (see Figure 17).



Figure 17. Oil Spillage

Patching and Utility Cut Patch: A patch is considered a defect, no matter how well it is performing (see Figure 18).



Figure 18. Patching and Utility Cut

Polished Aggregate: Aggregate polishing is caused by repeated traffic applications. Polished aggregate is present when close examination of a pavement reveals that the portion of aggregate extending above the asphalt is either very small, or there are no rough or angular aggregate particles to provide good skid resistance (see Figure 19).



Figure 19. Polished Aggregate

Raveling: Raveling is the dislodging of coarse aggregate particles from the pavement surface (see Figure 20). Debris from raveling can lead to FOD.



Figure 20. Raveling

Rutting: A rut is a surface depression in the wheel path. Pavement uplift may occur along the sides of the rut. However, in many instances, ruts are noticeable only after a rainfall, when the wheel paths are filled with water. Rutting stems from a permanent deformation in any of the pavement layers or subgrade, usually caused by consolidation or lateral movement of the materials due to traffic loads. Significant rutting can lead to major structural failure of the pavement (see Figure 21).



Figure 21. Rutting

Shoving of Asphalt Pavement by PCC Slabs: PCC pavements occasionally increase in length at ends where they adjoin flexible pavements (commonly referred to as “pavement growth”). This “growth” shoves the asphalt- or tar-surfaced pavements, causing them to swell and crack. The PCC slab “growth” is caused by a gradual opening of the joints as they are filled with incompressible materials that prevent them from reclosing (see Figure 22).



Figure 22. Shoving of Asphalt Pavement by PCC

Slippage Cracking: Crescent- or half-moon-shaped cracks having two ends pointed away from the direction of traffic. They are produced when braking or turning wheels cause the pavement surface to slide and deform. This usually occurs when there is a low-strength surface mix or poor bond between the surface and next layer of the pavement structure (see Figure 23).



Figure 23. Slippage Cracking

Swell-Distress: Swell is characterized by an upward bulge in the pavement's surface (Figure 24). A swell may occur sharply over a small area or as a longer, gradual wave. Either swell type can be accompanied by surface cracking. A swell is usually caused by frost action in the subgrade or by swelling soil, but a small swell can also occur on the surface of an asphalt overlay (over PCC) as a result of a blowup in the PCC slab (see Figure 24).



Figure 24. Swell Distress

Weathering (Surface Wear)—Dense Mix Asphalt: The wearing away of the asphalt binder and fine aggregate matrix from the pavement surface (see Figure 25).



Figure 25. Weathering (Surface Wear)

3.5 SUMMARY OF LITERATURE REVIEW

While there are many similarities between highway and airport asphalt pavements, loading characteristics are very different, both in number and magnitude. Although the frequency of loading is much lower for airports than highways, the load levels are much higher. Wheel configurations and traffic patterns are also considerably different. Because of these differences, rutting is a more critical concern than fatigue for airfield pavements, whereas the opposite is often true for highway pavements today. Unique design and serviceability requirements require a separate approach to the design of airfield pavements.

Construction requirements for airport pavement projects can also be different than those of highway pavement projects. A comparison was made of two highway agency asphalt specifications that have been used for airfield projects (ILDOT and GDOT) and two airport agency asphalt specifications (FAA P-401 and Unified Facilities Guide Specifications [UFGS] used for military airfield construction). Aggregate requirements are generally comparable, although UFGS requirements are slightly more stringent with respect to fractured faces. Likewise, binder requirements are very similar. With respect to mix design specifications, the FAA minimum requirements for VMA are higher than the state agency specifications. This combined with a lower FAA target for air voids results in substantially higher asphalt contents for FAA mixes which, in turn, will improve durability and cracking resistance. The FAA and UFGS QC requirements are generally more detailed than the state agency specifications, though not significantly more so. Acceptance criteria are generally similar, with similar in-place density requirements. Primary construction differences are that the state specifications do not have a requirement to cut back the longitudinal joint and do not include a joint density requirement.

Specifications have evolved over time as construction materials, techniques, and testing have improved. However, current specifications for both airfields and highways are still largely based on empirical relationships with performance. There is a significant need for PRSs to ensure satisfactory long-term pavement performance more effectively. Several highway agencies use

volumetric properties in conjunction with some type of performance test for asphalt pavement mixture design and acceptance. In general, limited work has been conducted in the area of performance specifications with respect to airport pavements.

As highway and airfield pavements age, distresses can occur because of traffic loads and environmental conditions. Properly identifying the type of surface distress is essential in determining the cause of the deterioration and in developing the appropriate method of rehabilitation. Condition rating systems are used to compare the performance of different pavement sections. This helps agencies determine the extent and severity of pavement defects, estimate the cost of repair and rehabilitation, and prioritize treatment procedures. The most common methods of evaluating airfield pavement conditions are the PCI and the PASER. PCI is a numerical rating ranging from 0 to 100, with 100 being the best possible condition. It is determined in accordance with ASTM D5340-12 (2018), which lists 16 airfield pavement distresses and deducts points based on type, severity, and extent of each observed distress. PASER is an estimated condition rating system with a 1–5 scale. The FAA recommends using it only when it is not possible to complete a more detailed PCI survey as part of a more comprehensive pavement maintenance management program.

4. METHODOLOGY

To assess the in-service performance of airport pavements constructed following state highway specifications for asphalt pavements, the initial plan was for staff from the FAA Airport Technology Research & Development (ATRD) to identify 30 airports that had used state highway specifications (rather than FAA specifications) for asphalt pavement construction. National Center for Asphalt Technology (NCAT) staff were to then follow-up with personnel from those airports to identify and review the following documents from each project:

- Construction plans and specifications
- QC and acceptance test data
- Aircraft traffic used for pavement thickness design
- History of any maintenance activities conducted on the airfield
- Current aircraft traffic and loading data

Following the document review, NCAT staff were to then conduct an on-site pavement condition assessment on each of the 30 airports in accordance with ASTM D5340 *Standard Test Method for Airport Pavement Condition Index Surveys* (2018).

Unfortunately, several issues were encountered that significantly impacted the proposed research activities. The ATRD staff had difficulty identifying airports that had been built using highway specifications, and NCAT staff assumed that responsibility. Because the FAA does not have any type of standardized record-storage system with respect to construction records, it was difficult to determine which projects were constructed using FAA specifications and which projects used highway specifications. NCAT staff contacted numerous FAA Regional Airport Divisions, the

Airport Consultants Council, and individual airports to identify potential projects, all with minimal success. The National Asphalt Pavement Association and the state asphalt pavement associations also assisted by contacting their contractor members to help identify projects, again with minimal success.

For the few projects that were identified, airport staff were typically contacted, and a request was made for the appropriate project records. In most of these instances, records were not available. When records were provided, they were generally limited and incomplete. The other factor that significantly impacted the project was the COVID-19 pandemic, which essentially eliminated the ability to travel for project inspections.

Because of the difficulties in identifying airfields constructed using state highway specifications, lack of available construction data, and the inability of NCAT staff to travel to inspect airports because of the pandemic, a decision was made to access pavement management reports provided by Applied Pavement Technology (APTech). APTech is an engineering firm that contracts with airports across the U.S. to conduct PCI inspections and visual evaluations of pavements. In addition, during their inspections, APTech also had access to some construction records (mainly plans) from recent rehabilitation projects of each airport. This information, coupled with records provided by several state DOT Divisions of Aeronautics/Aviation, provided access to information needed for the assessment.

The original plan was to evaluate 30 airport pavements representing a cross-section of airports from across the country. However, because of the challenges associated with acquiring construction and performance data from airports, only a few projects were included from each region, which was inadequate for drawing any statistical conclusions. Consequently, the research effort narrowed the focus to projects for which enough construction and performance data were available, which was primarily in the FAA Great Lakes Region. In addition to having more data available, using projects in this region provided an adequate number of projects from which to realistically draw conclusions. This included projects from Illinois, Indiana, Michigan, and Wisconsin. In addition, because data had already been acquired from several airport projects in Georgia, these projects were also included. Other considerations that factored into developing the final list of projects included:

- **Project age.** To better assess more recent construction and mix design methodologies, a decision was made to exclude older projects, and not include projects constructed prior to 2003. This represents the approximate year when most highway agencies had adopted the new Superpave mix design methodology. Conversely, projects that were considered too young (less than 2 years old) were also excluded because those projects would not be old enough to have meaningful changes in pavement condition.
- **Pavement type.** The original plan was to include all pavement types (runways, taxiways, aprons, and shoulders), but the available data shifted the focus to primarily runways. While some taxiway and apron projects were included, most projects were runways.

A total of 40 projects from 5 states (see Figure 26) were included in this analysis. To establish a basis for comparison, 21 of the projects used FAA specifications, and 19 projects used state highway specifications. A summary of the airports included is shown in Table 6.

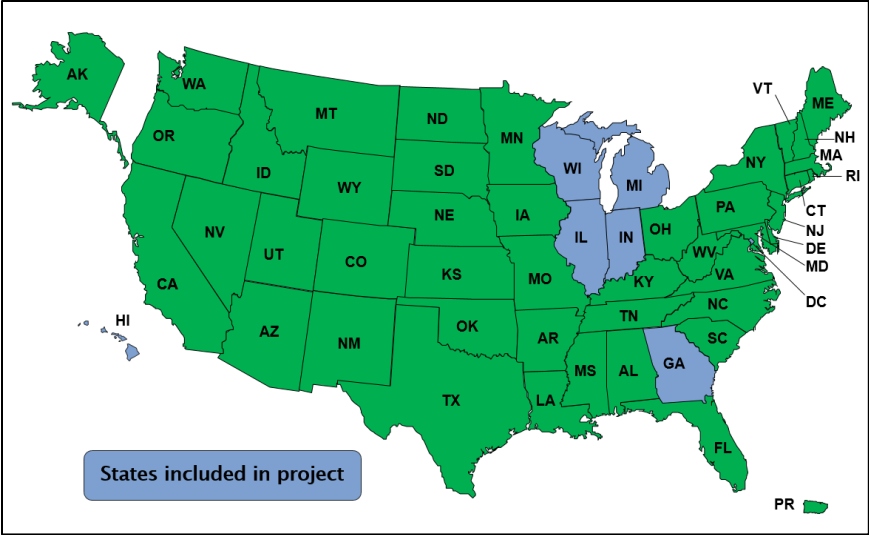

Figure 26. States Included in Project

Table 6. List of Airport Projects Evaluated

Project No.	State	Airport Name	Description	Year Paved	Specifications
1	Georgia	Columbus	Runway 06/24 rehabilitation	2011	FAA
2	Georgia	Columbus	Runway 13/31	2016	State
3	Georgia	Albany–Southwest Georgia Regional Airport	Runway 04/22 Rehabilitation	2018	FAA
4	Georgia	Athens-Ben Epps Airport (AHN)	Rehabilitation of Runway 09/27	2018	FAA
5	Georgia	Winder-Barrow County Airport (WDR)	Runway 05/23–Rehabilitation and Overlay	2009	FAA
6	Georgia	Winder-Barrow County Airport (WDR)	Runway 13/31–Rehabilitation and Overlay	2016	FAA
7	Georgia	Rome-Richard B. Russell Regional Airport	Rehabilitation of Runway 07/25	2019	State
8	Georgia	Dahlonega-Wimpy’s Lumpkin County Airport	Runway 15/33 Rehabilitation	2016	State
9	Illinois	Waukegan National Airport	Repair & Overlay Runway 14/32	2010	State
10	Illinois	Edgar County Airport	Construct Crosswind Runway 18/36	2011	State
11	Illinois	Bolingbrook’s Clow International Airport	Remove and Construct Runway 18/36 in new location	2015	State
12	Illinois	DuPage Airport	Rehab Runway 10/28	2013	State
13	Illinois	Chicago Executive Airport	Rehab Runway 16/34	2016	State
14	Wisconsin	Prairie du Chien	Runway 11/29	2012	State
15	Wisconsin	Fort Atkinson	Runway 03/21 reconstruction	2013	State
16	Wisconsin	Crandon	Reconstruct Runway 11/29	2012	State
17	Wisconsin	Clintonville	Runway 04/22 Reconstruction and Extension	2014	State
18	Wisconsin	Oconto	Rehabilitate runway 11/29	2017	State
19	Indiana	Anderson Municipal Airport (AID)	Construct Western portion of Taxiway A	2006	FAA
20	Indiana	Anderson Municipal Airport (AID)	Construct Eastern portion of Taxiway A	2008	FAA
21	Indiana	Columbus Municipal (BAK)	Construct majority of Taxiway D	2012	FAA
22	Indiana	Logansport - Cass County (GGP)	Reconstruct Runway 09/27	2003	FAA
23	Indiana	Peru Municipal (I76)	Construct majority of Runway 01/19	2009	FAA
24	Michigan	Cheboygan County Airport (SLH)	Reconstruct Runway 17/35	2010	State
25	Michigan	Houghton County Memorial Airport (CMX)	Reconstruct Runway 7/25	2010	State

Project No.	State	Airport Name	Description	Year Paved	Specifications
26	Michigan	Kirsch Municipal Airport (IRS)	Reconstruct Runway 06/24	2013	State
27	Michigan	Marlette Township Airport (77G)	Runway 01/19 Mill and Overlay	2015	State
28	Michigan	Oakland County International Airport (PTK)	Construct Runway 18/36	2006	State
29	Michigan	St. Clair County International Airport (PHN)	Reconstruct Runway 10/28	2005	FAA
30	Wisconsin	Amery Municipal Airport (AHH)	Reconstruct Runway 18/36	2015	FAA
31	Wisconsin	Baraboo-Wisconsin Dells Regional (DLL)	Reconstruct Apron	2011	FAA
32	Wisconsin	Bloyer Field (Y72)	Reconstruct Apron	2014	FAA
33	Wisconsin	Bloyer Field (Y72)	Reconstruct half of Taxiway A	2014	FAA
34	Wisconsin	Cumberland Municipal Airport (UBE)	Reconstruct Apron	2015	FAA
35	Wisconsin	Cumberland Municipal Airport (UBE)	Reconstruct Runway 9-27	2015	FAA
36	Wisconsin	Cumberland Municipal Airport (UBE)	Reconstruct Taxiway A	2015	FAA
37	Wisconsin	East Troy Municipal Airport (57C)	Reconstruct Runway 08/26	2014	FAA
38	Wisconsin	East Troy Municipal Airport (57C)	Construct majority of Taxiway B	2003	State
39	Wisconsin	Fond Du Lac County Airport (FLD)	Construct Apron area	2007	FAA
40	Wisconsin	Park Falls Municipal Airport (PKF)	Reconstruct Runway 18/36	2015	FAA

To assess the performance of each project, this study focused on the PCI. The PCI is a score from 0–100 that is determined by a visual survey of pavement distresses based on ASTM D5340-12 (2018). PCI data (obtained from pavement management reports provided by APTech) were compiled and summarized for each project previously listed in Table 6 as shown in Table 7. On several of the projects, the element being inspected was broken into sections. When reviewing the data in Table 7 the following should be noted:

- For the year the pavement was constructed or rehabilitated, a PCI value of 100 was assigned (even though a PCI inspection did not occur), and the cell was highlighted in green.
- For projects that had multiple sections evaluated, the average for the sections was determined and used as the final PCI value.

Table 7. Project PCI Ratings Summary Complete

No.	State	Airport Name	Year Paved	Specifications	Notes	Pavement Condition Index (PCI)																					
						2003	2004	2005	2006	2007	2008	2009	2010	2011	2012	2013	2014	2015	2016	2017	2018	2019	2020				
1	Georgia	Columbus	2010	FAA	Section 10C								100		90						83						
			2010	FAA	Section 10E									100		95						76					
			2010	FAA	Section 10W									100		92						78					
			2010	FAA	Average									100		92.3						79					
2	Georgia	Columbus	2016	State	Section 10																	100	91				
			2016	State	Section 20																		100	90			
			2016	State	Section 30																			100	100		
			2016	State	Average																			100	93.7		
3	Georgia	Albany–Southwest Georgia Regional Airport	2019	FAA																							
4	Georgia	Athens-Ben Epps Airport (AHN)	2018	FAA																			100				
5	Georgia	Winder-Barrow County Airport (WDR)	2009	FAA	Section 10							100			85									74			
6	Georgia	Winder-Barrow County Airport (WDR)	2016	FAA																		100		89			
7	Georgia	Rome-Richard B. Russell Regional Airport	2018	State	Section 10																			100			

No.	State	Airport Name	Year Paved	Specifications	Notes	Pavement Condition Index (PCI)																				
						2003	2004	2005	2006	2007	2008	2009	2010	2011	2012	2013	2014	2015	2016	2017	2018	2019	2020			
8	Georgia	Dahlonega–Wimpy’s Lumpkin County Airport	2015	State														100			96					
9	Illinois	Waukegan National Airport	2011	State	Section 1									100	96				83			65				
			2011	State	Section 2										100	95				82			65			
			2011	State	Section 3											100	93				78			61		
			2011	State	Section 4A											100	87				82			69		
			2011	State	Section 5A												100	95				82			71	
			2011	State	Section 6												100	95				81			67	
			2011	State	Section 7												100	95				80			61	
			2011	State	Average									100	93.7				81.1			65.6				
10	Illinois	Edgar County Airport	2012	State											100	100			79			76				
11	Illinois	Bolingbrook’s Clow International Airport	2015	State														100	100			79				
12	Illinois	DuPage Airport	2013	State	Section 1												100	95			87		78			
			2013	State	Section 2													100	97			89		82		
			2013	State	Average													100	96			88		80		
13	Illinois	Chicago Executive Airport	2016	State	Section 1														100	89			83			
			2016	State	Section 2															100	90			80		
			2016	State	Section 3															100	89			81		
			2016	State	Section 4															100	91			79		
			2016	State	Section 5															100	93			81		
			2016	State	Average															100	90.4			80.8		
14	Wisconsin	Prairie du Chien	2012	State	Section 10									100	98				81				73			
			2012	State	Section 20											100	98			80				78		
			2012	State	Average											100	98			80.5				75.5		

No.	State	Airport Name	Year Paved	Specifications	Notes	Pavement Condition Index (PCI)																				
						2003	2004	2005	2006	2007	2008	2009	2010	2011	2012	2013	2014	2015	2016	2017	2018	2019	2020			
15	Wisconsin	Fort Atkinson	2013	State	Section 10											100			92				79			
			2013	State	Section 20												100			92				88		
			2013	State	Section 30												100			94					90	
			2013	State	Average												100			92.7					85.7	
16	Wisconsin	Crandon	2012	State	Section 10										100	100			85					69		
17	Wisconsin	Clintonville	2014	State													100		95						84	
18	Wisconsin	Oconto	2017	State																	100				84	
19	Indiana	Anderson Municipal Airport (AID)	2006	FAA	Section 05				100							81			63						58	
20	Indiana	Anderson Municipal Airport (AID)	2008	FAA	Section 10						100					99			77						72	
			2008	FAA	Section 15							100					95			66						61
			2008	FAA	Average							100					97			71.5						66.5
21	Indiana	Columbus Municipal (BAK)	2012	FAA	Section 10										100	100			91						85	
22	Indiana	Logansport - Cass County (GGP)	2003	FAA	Section 10	100												69							60	
23	Indiana	Peru Municipal (176)	2009	FAA	Section 20							100						83							80	
24	Michigan	Cheboygan County Airport (SLH)	2010	State									100			100							89			80
25	Michigan	Houghton County Memorial Airport (CMX)	2010	State									100		100			95								84
26	Michigan	Kirsch Municipal Airport (IRS)	2013	State												100		96								84

No.	State	Airport Name	Year Paved	Specifications	Notes	Pavement Condition Index (PCI)																	
						2003	2004	2005	2006	2007	2008	2009	2010	2011	2012	2013	2014	2015	2016	2017	2018	2019	2020
27	Michigan	Marlette Township Airport (77G)	2015	State													100		98			89	
28	Michigan	Oakland County International Airport (PTK)	2006	State				100					99			86			69			65	
29	Michigan	St. Clair County International Airport (PHN)	2005	FAA			100			93				82			70			60			
30	Wisconsin	Amery Municipal Airport (AHH)	2015	FAA	Section 10												100	100				77	
			2015	FAA	Section 20													100	100				83
			2015	FAA	Average													100	100				80
31	Wisconsin	Baraboo-Wisconsin Dells Regional (DLL)	2011	FAA	Section 10								100	100			79			73			
32	Wisconsin	Bloyer Field (Y72)	2014	FAA	Section 10											100			93			87	
33	Wisconsin	Bloyer Field (Y72)	2014	FAA	Section 10											100			92			90	
34	Wisconsin	Cumberland Municipal Airport (UBE)	2015	FAA													100	100				77	
35	Wisconsin	Cumberland Municipal Airport (UBE)	2015	FAA	Section 20												100	100				75	
36	Wisconsin	Cumberland Municipal Airport (UBE)	2015	FAA													100	100				83	

No.	State	Airport Name	Year Paved	Specifications	Notes	Pavement Condition Index (PCI)																	
						2003	2004	2005	2006	2007	2008	2009	2010	2011	2012	2013	2014	2015	2016	2017	2018	2019	2020
37	Wisconsin	East Troy Municipal Airport (57C)	2014	FAA												100	87				76		
38	Wisconsin	East Troy Municipal Airport (57C)	2003	State	Section 10	100		100				82			68		67				61		
39	Wisconsin	Fond Du Lac County Airport (FLD)	2007	FAA	A01FO-30					100		95			89		84					69	
40	Wisconsin	Park Falls Municipal Airport (PKF)	2015	FAA	Section 20												100	100					83

5. PROJECT SUMMARIES

To assess the overall performance of each airfield and determine any relationship between design, specifications, construction, and overall performance, project records were reviewed for each project (when available), and performance data were summarized and analyzed. A brief summary of each project by state follows. A more detailed summary of each project is available in appendix A.

5.1 GEORGIA

In Georgia, eight projects were reviewed. Five projects used FAA specifications, and three used GDOT highway specifications. The highway specifications used were the 2013 Standard Specifications: Construction of Transportation Systems, published by GDOT, Sections 400 and 800 (GDOT, 2013). A review of the Georgia surface course specification, as compared to the current FAA surface course specification (P-401 was the only surface course specification used), is summarized in appendix B.

5.1.1 Columbus Airport

The Columbus Airport (CSG) is a primary commercial service airport. It is located 4 miles northeast of Columbus, in Muscogee County, Georgia. Runway 06/24 was repaired and overlaid in 2011 using FAA specifications. Runway 13/31 was repaired and overlaid in 2016 using state specifications. Work on both runways 06/24 and 13/31 consisted of a 2-in. mill and resurfacing with a cross slope that varies through the entire runway. Aircraft operations for the airport totaled 36,760 aircraft annually based on 2018 data (ADIP, 2021). Runway 06/24 has the following load ratings: dual wheel (D)–160,000 lb; two dual wheels in tandem (2D)–250,000 lb. Runway 13/31 had the following load rating: single wheel (S)–12,000 lb. With respect to performance, the most prevalent types of distress throughout both runways include low- to medium-severity longitudinal and transverse cracking. Most of the distress deducts are associated with climate, and none of the deducts are associated with load. The average PCI measured in 2018 was 78.5 for Runway 06/24 and 93.6 for Runway 13/31. A plot of the PCI ratings since the most recent rehabilitation for Runway 06/24 is shown in Figure 27.

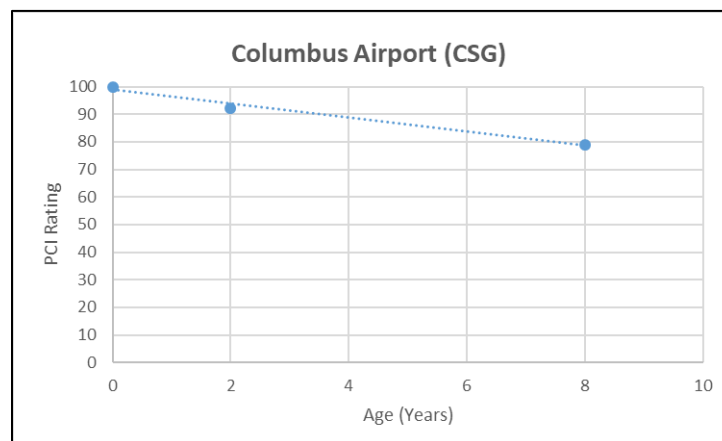

Figure 27. Columbus Airport (CSG) Runway 06/24 PCI Ratings

5.1.2 Albany Airport

The Albany Airport (ABY) is a non-hub, commercial service airport with approximately 15,000 annual operations. It is located 4 miles southwest of the city of Albany, Georgia. Runway 04/23 was repaired and overlaid in 2019 using FAA specifications. Work on Runway 04/23 consisted of a 3-in. overlay over a double surface treatment. Runway 04/23 has the following load ratings: single wheel (S)–80,000 lb; dual wheel (D)–135,000 lb; two dual wheels in tandem (2D)–230,000 lb. No PCI inspections have yet occurred on this runway, and it was assigned a PCI rating of 100. Prior to this rehabilitation, the reported PCI in 2012 was 61 with distresses including alligator cracking, longitudinal and transverse cracking, rutting, swelling, and weathering.

5.1.3 Athens-Ben Epps Airport

The Athens–Ben Epps Airport (AHN) is a county-owned, public-use airport located 3.75 miles east of the central business district of Athens, a city in Clarke County, Georgia. Runway 09/27 was rehabilitated in 2019 using FAA specifications. Overall, the plans included a reconstruction of a 6-in. asphalt concrete layer. Aircraft operations for the airport total 40,260 aircraft annually based on 2018 data (ADIP, 2021). Runway 09/27 has the following load ratings: single wheel (S) – 65,000 lb; dual wheel (D)–125,000 lb. The PCI measured in 2019 was 100 with no distresses noted. Prior to this rehabilitation, the reported PCI in 2012 was 70 with several distresses, including alligator cracking, and longitudinal and transverse cracking.

5.1.4 Winder-Barrow Airport

The Winder-Barrow Airport (WDR) is a public-use airport located 3 miles east of the central business district of Winder, a city in Barrow County, Georgia. It has two runways. Runway 05/23 was rehabilitated in 2009 using FAA specifications, and Runway 13/31 was rehabilitated in 2016, also using FAA specifications. Work on both runways consisted of 1.5-in. mill and fill rehabilitation strategy. Aircraft operations total 40,000 aircraft annually based on 2018 data (ADIP, 2021). Both runways have the following load rating: single wheel (S)–20,000 lb. With respect to performance, the most prevalent type of distress throughout both runways was longitudinal and transverse cracking. None of the deducts are associated with load. The PCI measured in 2012 (3 years after rehabilitation) was 85 for Runway 06/24. The PCI measured in 2018 (2 years after rehabilitation) was 89 for Runway 13/31.

5.1.5 Richard B. Russell Regional Airport

The Richard B. Russell Regional Airport (RMG) is a county-owned, public-use airport in Floyd County, Georgia. The airport is located 7.5 miles north of the central business district of Rome, Georgia. It is also known as the Richard B. Russell Regional Airport. Runway 07/25 was rehabilitated in 2018 using GDOT highway specifications. Work on Runway 07/25 consisted of a 2-in. mill and fill rehabilitation. Aircraft operations total 61,000 aircraft annually based on 2018 data (ADIP, 2021). Runway 07/25 has the following load rating: single wheel (S)–16,000 lb and dual wheel (D)–30,000 lb. Prior to this rehabilitation, the reported PCI in 2012 was 54 with distresses, including block cracking, raveling, and weathering.

5.1.6 Lumpkin County-Wimpys Airport

The Lumpkin County-Wimpys Airport (9A0) is located 3 miles from Dahlonega, Georgia. Runway 15/33 was rehabilitated in 2018 using GDOT highway specifications. The limited construction information that was located did not specify the thickness of the new asphalt concrete layer or any other rehabilitation information. Aircraft operations total 5,600 aircraft annually (2018 data). Runway 15/33 has the following load rating: single wheel (S)–12,000 lb. With respect to performance, the most prevalent type of distress was longitudinal and transverse cracking. No deducts are associated with load. The PCI measured in 2019 was 96. Prior to this rehabilitation, the reported PCI in 2012 was 79.

5.2 ILLINOIS

In Illinois, five projects were evaluated, and all five used the Illinois Standard Specifications for Construction of Airports (2012). Items 401 (Bituminous Surface Course–Superpave) and 403 (Bituminous Base Course–Superpave) were the governing specifications for the asphalt. A review of the Illinois surface course specification (Item 401), compared to the current FAA surface source specification (P-401), is summarized in appendix B.

5.2.1 Waukegan National Airport

The Waukegan National Airport (UGN) is a general aviation facility categorized by the FAA as a Reliever Airport for Chicago's O'Hare International. It is located 35 miles north of Chicago in Lake County, Illinois. Runway 14/32 was repaired and overlaid in 2010 using the ILDOT airport specifications. Work consisted of partial depth bituminous repair, a bituminous base leveling course (Item 201) overlay with a depth that varied from 2–3 in., followed by a 1.5-in. surface course (Item 401). Aircraft operations total 45,015 aircraft annually based on 2018 data (ADIP, 2021). Runway 14/32 has the following load ratings: single wheel (S)–16,000 lb; dual wheel (D)–23,000 lb. With respect to performance, the most prevalent types of distress include weathering, medium-severity joint reflective cracking, and medium-severity longitudinal and transverse cracking. Most of the distress deducts are associated with climate, with a small percentage associated with “other.” None of the deducts are associated with load. Figure 28 shows a plot of the PCI ratings since the most recent rehabilitation.

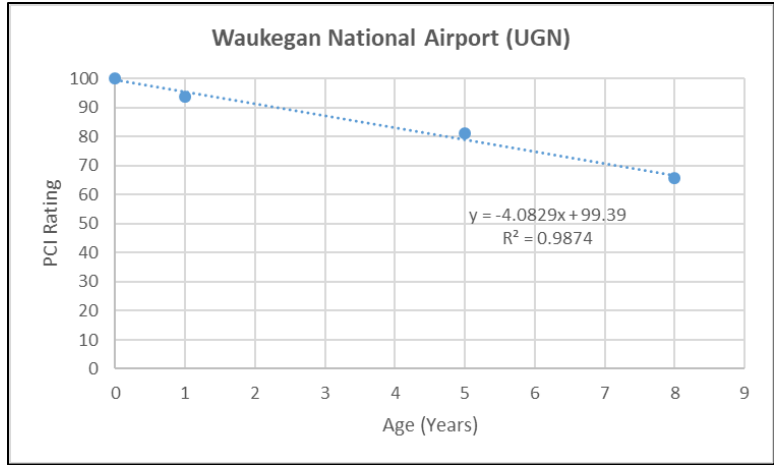

Figure 28. Waukegan National Airport (UGN) Runway 14/32 PCI Ratings

5.2.2 Edgar County Airport

The Edgar County Airport (PRG) is a publicly owned, general aviation airport in Edgar County, Illinois. It is located approximately 40 miles southeast of Champaign, Illinois, and 75 miles west of Indianapolis, Indiana. Runway 18/36 is a new runway constructed in 2012 using the ILDOT airport specifications. Construction consisted of 16 in. of lime stabilized subgrade (Item 152), 6 in. of crushed aggregate base (Item 209), 2.5 in. of asphalt base course (Item 403), and 1.5 in. of asphalt surface course (Item 401). Aircraft operations total 6,900 aircraft annually based on 2019 data (ADIP, 2021). Load ratings for the runway were not available. With respect to performance, the two most prevalent types of distresses were medium- and low-severity longitudinal and transverse cracking. Weathering was also a noted distress. All the distress deducts on the project were associated with climate; none of the deducts were associated with load. A plot of the PCI ratings since the most recent rehabilitation is shown in Figure 29.

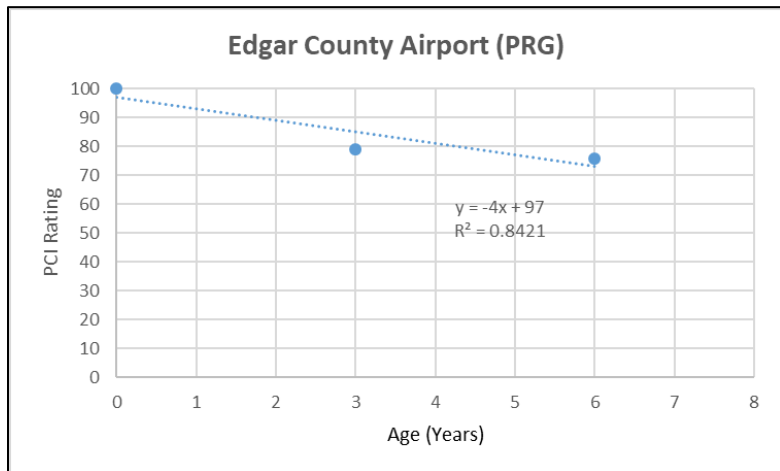

Figure 29. Edgar County Airport (PRG) Runway 18/36 PCI Ratings

5.2.3 Bolingbrook's Clow International Airport

Bolingbrook's Clow International Airport (1C5) is a public airport located in Bolingbrook, a village in Will County, Illinois. It is a general aviation facility located 29 miles southwest of Chicago. Runway 18/36 was last rehabilitated in 2016 using the ILDOT airport specifications. The rehabilitation consisted of the removal of the existing runway and connecting taxiway pavements, followed by the placement of a 6-in. granular drainage subbase (Item 800), 6 in. of crushed aggregate base (Item 209), 4 in. of bituminous base course (Item 403), and 2 in. of bituminous surface course (Item 401). Aircraft operations total 50,000 aircraft annually based on 2020 data (ADIP, 2021). Runway 18/36 has the following load rating: single wheel (S)–12,500 lb. With respect to performance, the three most prevalent types of distresses were low-severity longitudinal and transverse cracking, raveling, and weathering. All the distress deducts on the project were associated with climate; none of the deducts were associated with load. A plot of the PCI ratings since the most recent rehabilitation is shown in Figure 30.

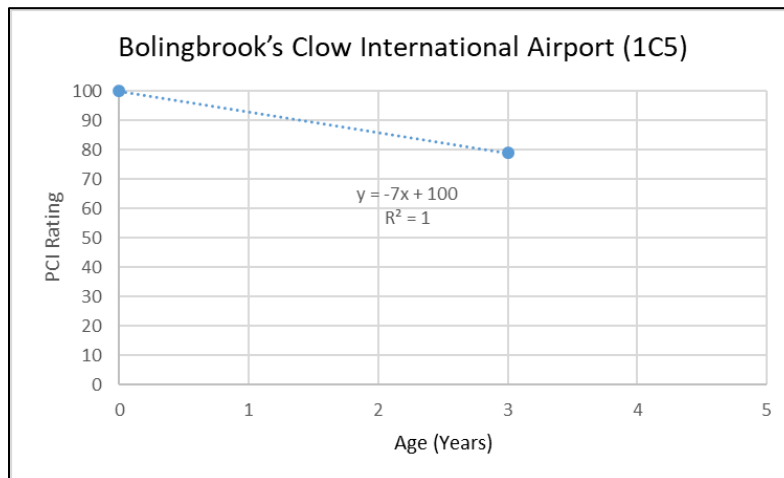

Figure 30. Bolingbrook's Clow International Airport (1C5) Runway 18/36 PCI Ratings

5.2.4 DuPage Airport

The DuPage Airport (DPA) is a general aviation airport located 29 miles west of downtown Chicago in West Chicago, DuPage County, Illinois. It serves as a relief airport for O'Hare International Airport and Chicago Midway International Airport, both in nearby Chicago. The airport has an FAA service level classification as Reliever. The most recent rehabilitation of Runway 10/28 occurred in 2013 using the ILDOT airport specifications and consisted of variable depth milling (1.25 in. at centerline to 2 in. at the pavement edge), followed by the placement of a 1-in. leveling course (Item 401) and a 2-in. bituminous surface course (Item 401). Aircraft operations total 133,110 aircraft annually based on 2019 data (ADIP, 2021). Runway 10/28 has the following load ratings: single wheel (S)–30,000 lb and dual wheel (D)–45,000 lb. With respect to performance, the primary modes of distress include low-severity longitudinal and transverse cracking, low-severity alligator cracking, and low-severity weathering. Sixty-four percent of the distress deducts were climate related and 36% were load related. A plot of the PCI ratings since the most recent rehabilitation is shown in Figure 31.

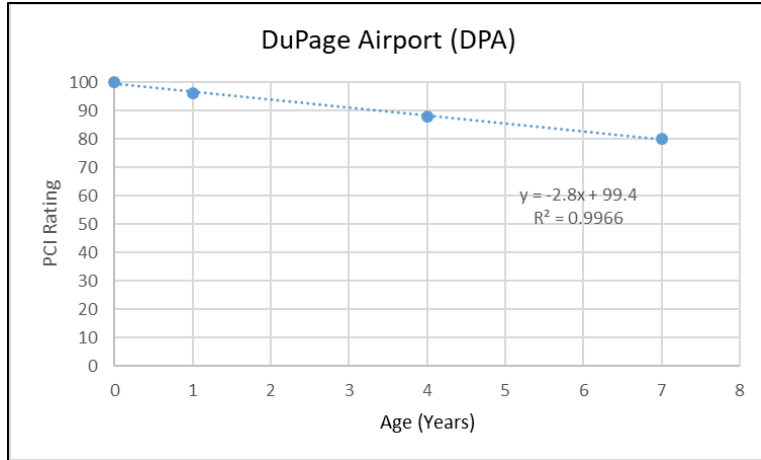

Figure 31. DuPage Airport (DPA) Runway 10/28 PCI Ratings

5.2.5 Chicago Executive Airport

The Chicago Executive Airport (PWK) is a publicly owned airport located in Cook County, Illinois, 21 miles NW of downtown Chicago and 9 miles due north of the O’Hare International Airport. It is the fourth busiest airport in Illinois and has an FAA service level classification of Reliever. The most recent rehabilitation occurred in 2016 using ILDOT airport specifications and consisted of milling to a depth of 4 in., followed by the placement of 4 in. of asphalt surface mix (Item 401) and pavement grooving. Aircraft operations total 77,321 aircraft annually (2017 data). Runway 16/34 has the following load ratings: single wheel (S)–72,000 lb; dual wheel (D)–98,000 lb. With respect to performance, the most prevalent types of distress throughout the project include low- and medium-severity longitudinal and transverse cracking, low- and medium-severity weathering, with one section having high-severity raveling. All the distress deducts were associated with climate. A plot of the PCI ratings since the most recent rehabilitation is shown in Figure 32.

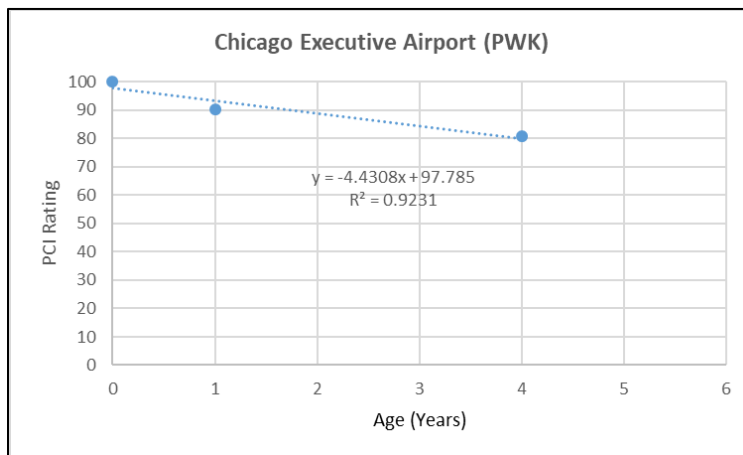

Figure 32. Chicago Executive Airport (PWK) Runway 16/34 PCI Ratings

5.3 INDIANA

The specifications used for all the Indiana projects were FAA specifications. Projects rehabilitated with state DOT highway specifications were not found during this research project.

5.3.1 Anderson Municipal Airport

The Anderson Municipal Airport (AID) is categorized as a general aviation facility and is located 3 miles east of Anderson in Madison County, Indiana. The rehabilitation and overlay of Taxiway A Sections 5, 10, and 15 were completed in 2006, 2008, and 2008, respectively, using FAA specifications. No plans or bidding documents were located for this project. Aircraft operations total 19,359 aircraft annually (2018 data). Runway 12/30 (which is connected to Taxiway A) has the following load rating: single wheel (S)–45,000 lb; dual wheel (D)–55,000 lb.; two dual wheels in tandem (2D)–85,000 lb. With respect to performance, the most prevalent types of distress throughout Taxiway A include low- to medium-severity longitudinal and transverse cracking along with low-severity raveling and weathering. Small amounts of low-severity rutting were observed on Section 15. The PCI measured in 2019 was on average 58, 72, and 61 for Sections 5, 10, and 15, respectively. A plot of the PCI ratings since the most recent rehabilitation is shown in Figure 33.

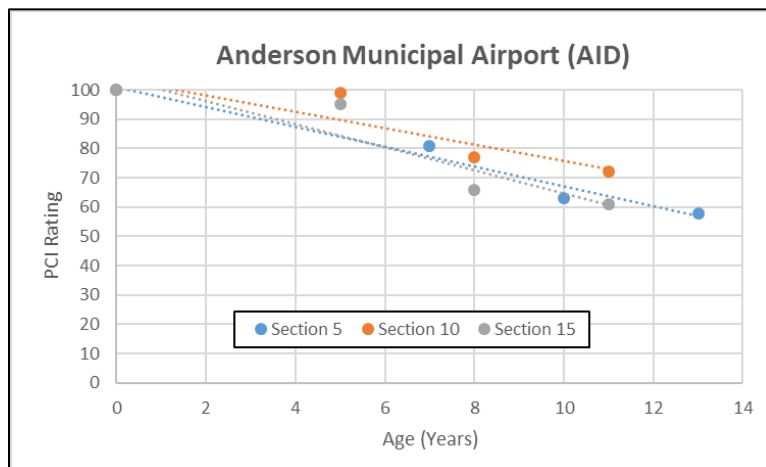

Figure 33. Anderson Municipal Airport (AID) Taxiway A PCI Ratings

5.3.2 Columbus Municipal Airport

The Columbus Municipal Airport (BAK) is 3 miles north of Columbus in Bartholomew County, Indiana. The rehabilitation of Taxiway D sections 10 and 15 was completed in 2012 using FAA specifications. No details of the work performed on this taxiway were located for this project. Aircraft operations total 42,248 aircraft annually (2018 data). Runways at Columbus Municipal Airport (which are connected to Taxiway D) have the following load ratings: single wheel (S)–75,000 lb; dual wheel (D)–130,000 lb; two dual wheels in tandem (2D)–200,000 lb. With respect to performance, the most prevalent types of distress throughout Taxiway D include low-to-medium severity longitudinal and transverse cracking along with low-severity weathering. The PCI

measured in 2019 was on average 85, and 86 for sections 10 and 15, respectively. A plot of the PCI ratings since the most recent rehabilitation for Section 10 is shown in Figure 34.

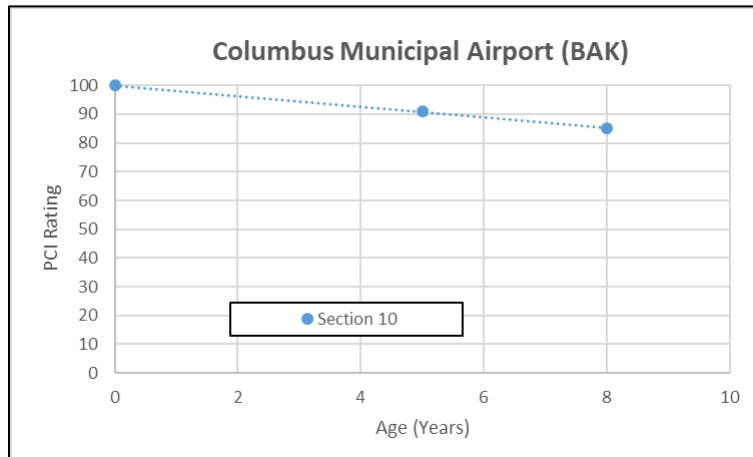

Figure 34. Columbus Municipal Airport (BAK) Taxiway D PCI Ratings

5.3.3 Logansport-Cass County Airport

The Logansport - Cass County Airport (GGP) is a public airport 2 miles south of Logansport in Cass County, Indiana. The rehabilitation of Runway 09/27 was completed in 2003 using FAA specifications. No plans or bidding documents were located for this project. Aircraft operations total 7,816 aircraft annually (2018 data). Runway 09/27 has the following load rating: single wheel (S)–20,000 lb. With respect to performance, the most prevalent types of distress throughout Runway 09/27 include low-, medium-, and high-severity longitudinal and transverse cracking. The PCI measured in 2019 was on average 60 for Section 10 of Runway 09/27.

5.3.4 Peru Municipal Airport

The Peru Municipal Airport (I76) is a public airport located 4 miles northwest of Peru in Miami County, Indiana. Reconstruction of Runway 01/19 was completed in 2009 using FAA specifications. No plans or bidding documents were located for this project. Aircraft operations total 2,546 aircraft annually (2018 data). Runway 01/19 has the following load rating: single wheel (S)–10,000 lb. With respect to performance, the most prevalent types of distress throughout Runway 01/19 include low-to-medium severity longitudinal and transverse cracking, low-severity weathering, and medium-severity alligator cracking. The PCI measured in 2018 was on average 80 for section 20 of Runway 1/19.

5.4 MICHIGAN

Six projects in Michigan were included in this evaluation, and except for the St. Clair County International Airport (PHN), which used FAA specifications, all projects used the Michigan Department of Transportation Airports Division Standard Specification (Plant Mix Bituminous Pavements) with an FAA approval date of October 10, 2007. A review of the Michigan specification (Item P-411), as compared to the current FAA surface source specification (P-401), is summarized in appendix B.

5.4.1 Cheboygan County Airport

The Cheboygan County Airport (SLH) is a public-use airport located 2 miles west of the city of Cheboygan in Cheboygan County, Michigan. It is owned by the Cheboygan Airport Authority. It is classified by the FAA as a general aviation facility. The runway was constructed in 2010 using Michigan DOT airport specifications. Work consisted of 6 in. of an aggregate base course (P-208), followed by the placement of two 1.5-in. layers of bituminous structural course. Aircraft operations total 6,854 aircraft annually (2017 data). Runway 17/35 has the following load ratings: single wheel (S)–23,000 lb; dual wheel (D)–34,000 lb; and two dual wheels in tandem (2D)–60,000 lb. The most prevalent types of distress throughout the runway include medium-severity swelling, low-severity alligator cracking, and low- and medium-severity longitudinal and transverse cracking. Of the distress deducts, 17% are related to load, 49% to climate, and 34% to other. A plot of the PCI ratings since the most recent rehabilitation is shown in Figure 35.

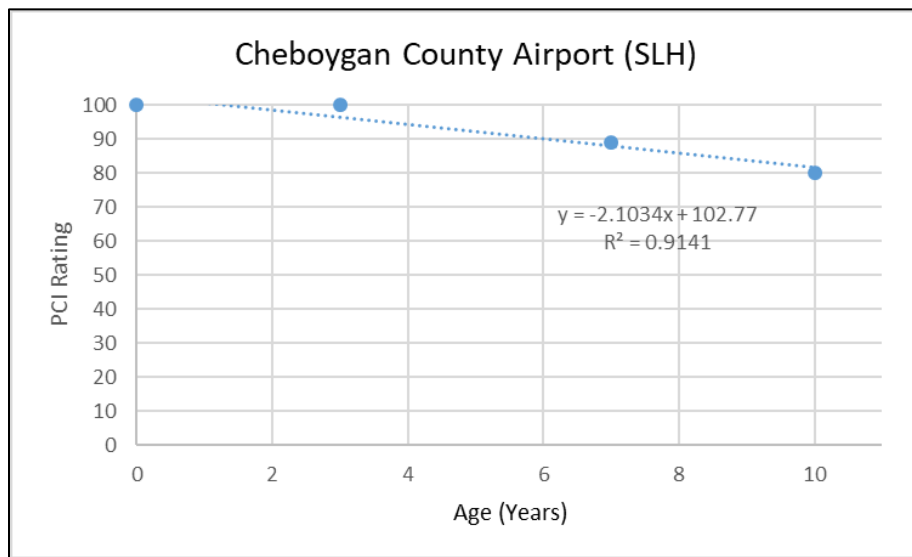

Figure 35. Cheboygan County Airport (SLH) Runway 17/35 PCI Ratings

5.4.2 Houghton County Memorial Airport

The Houghton County Memorial Airport (CMX) is a county-owned, public-use airport located 5 miles southwest of Calumet in Houghton County, Michigan. The airport is situated on the Keweenaw Peninsula in the northwest part of the Upper Peninsula of Michigan. The runway was reconstructed in 2010 using Michigan DOT airport specifications. Work consisted of the placement of 17 in. of non-frost susceptible Type 3 subbase with a 6-in. maximum size, 24 in. of non-frost susceptible Type 2 subbase, 3 in. maximum size placed in two layers, 4 in. non-frost susceptible Type 1 base, 1.5 in. maximum size, 6 in. of bituminous aggregate base course placed in three 2-in. lifts, and 3 in. of bituminous surface course placed in two 1.5-in. lifts. Aircraft operations total 16,054 aircraft annually (2019 data). Runway 07/25 has the following Pavement Classification Number (PCN): 18/F/C/X/U, and the following load rating: single wheel (S)–70,000 lb; dual wheel (D)–100,000 lb; and two dual wheels in tandem (2D)–185,000 lb. Primary distresses include longitudinal and transverse cracking, raveling, and weathering (all low-severity). All

distress deducts are climate related. A plot of the PCI ratings since the most recent rehabilitation is shown in Figure 36.

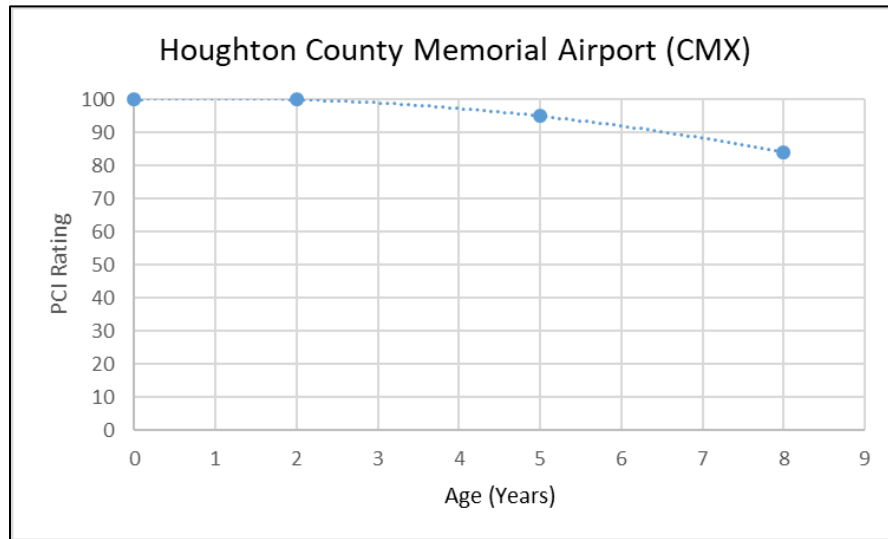

Figure 36. Houghton County Memorial Airport (CMX) Runway 07/25 PCI Ratings

5.4.3 Kirsch Municipal Airport

The Kirsch Municipal Airport (IRS) is a publicly owned, public-use airport located in the city of Sturgis, Michigan. The airport is in the southern portion of Michigan, roughly 5 miles north of the Indiana border. The most recent rehabilitation occurred in 2013, using Michigan DOT airport specifications, and consisted of 9 in. to 12 in. of pulverized bituminous/ P-208 aggregate base, 1.5 in. of bituminous leveling course (P-411), and 1.5 in. of bituminous surface course (P-411). The pulverized bituminous layer is likely referring to full depth reclamation, which is covered under P-207. Aircraft operations total 8,000 aircraft annually (2016 data). Runway 06/24 has the following load rating: single wheel (S)–19,000 lb; dual wheel (D)–25,000 lb; and two dual wheels in tandem (2D)–58,000 lb. Primary distresses include longitudinal and transverse cracking, raveling, and weathering (all low severity). All the distress deducts are climate related. A plot of the PCI ratings since the most recent rehabilitation is shown in Figure 37.

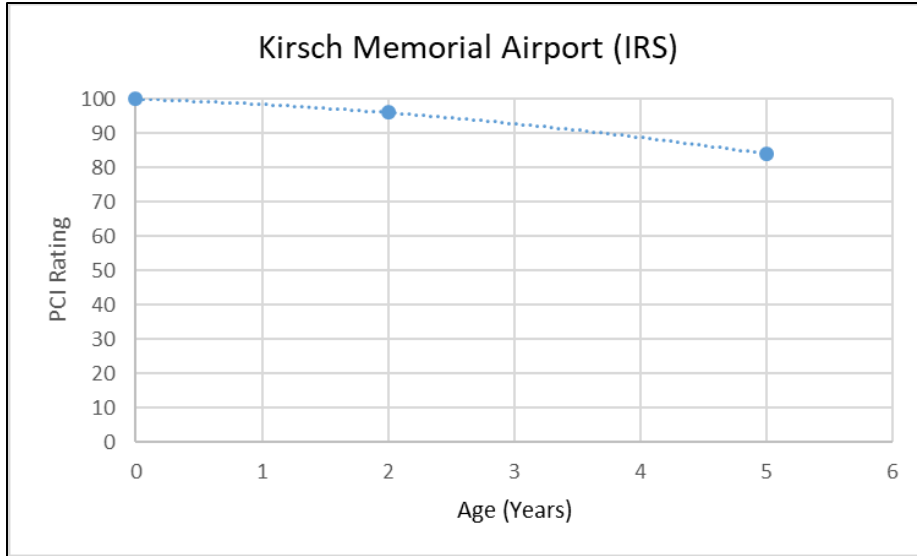

Figure 37. Kirsch Memorial Airport (IRS) Runway 06/24 PCI Ratings

5.4.4 Marlette Township Airport

The Marlette Township Airport (77G) is a publicly owned, general aviation airport located in Marlette Township, Michigan. The airport is located approximately 60 miles north of Detroit. It has an FAA service level classification of General Aviation. The most recent rehabilitation to Runway 01/19 occurred in 2015 using ILDOT airport specifications. Work consisted of milling 3 in. followed by the placement of two layers of bituminous surface course (P-411), each at a thickness of 1.5 in. Aircraft operations total 10,000 aircraft annually (2017 data). Load ratings for Runway 01/19 were not available. Primary distresses include low-severity longitudinal and transverse cracking and weathering. All the distress deducts are climate related. A plot of the PCI ratings since the most recent rehabilitation is shown in Figure 38.

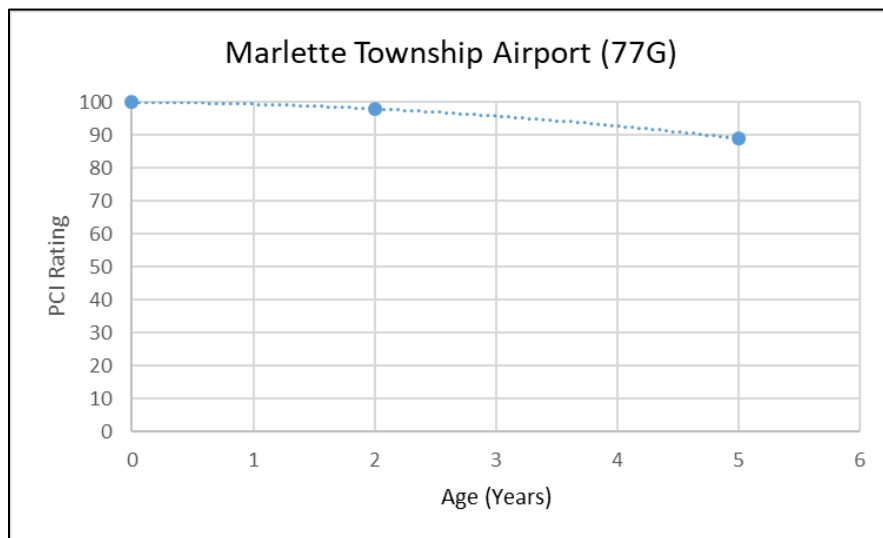

Figure 38. Marlette Township Airport (77G) Runway 01/19 PCI Ratings

5.4.5 Oakland County International Airport

The Oakland County International Airport (PTK) is a county-owned, public-use airport located in Waterford Township, Oakland County, Michigan. It is located approximately 30 miles northwest of Detroit and 30 miles due north of the Detroit Metropolitan Wayne County Airport. The airport has an FAA service level classification as Reliever. Runway 18/36 was last rehabilitated in 2006 using ILDOT airport specifications. Plans for the project were not available. The overall airport traffic operations totaled 123,332 aircraft (2020 data). Load ratings for Runway 18/36 were not available. With respect to performance, the most prevalent types of distress throughout the runway include high-, medium-, and low-severity longitudinal and transverse cracking, and medium-severity weathering. All the distress deducts are related to climate. A plot of the PCI ratings since the most recent rehabilitation is shown in Figure 39.

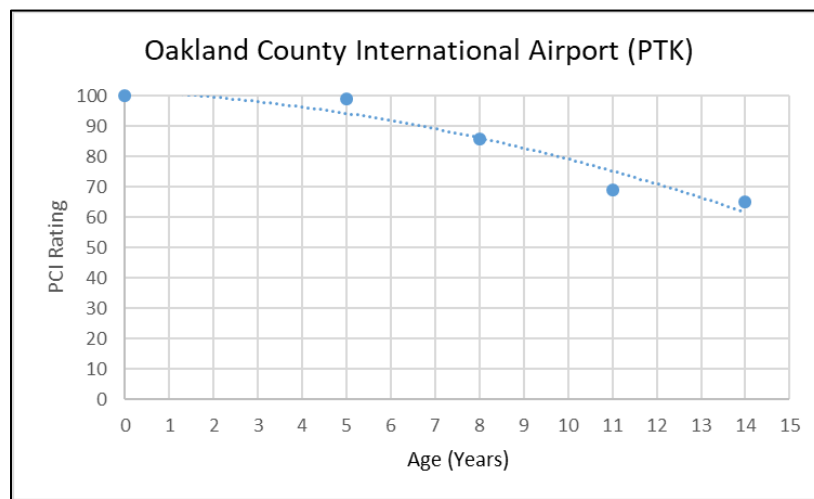

Figure 39. Oakland County Airport (PTK) Runway 18/36 PCI Ratings

5.4.6 St. Clair County International Airport

The St. Clair County International Airport (PHN) is a public airport owned by the government of St. Clair County, Michigan. It is in Kimball Township, 5 miles southwest of the central business district of Port Huron. The airport has an FAA service level classification as Reliever. Runway 10/28 was most recently rehabilitated in 2005 using FAA specifications. Plans for the project were not available. The overall airport traffic operations totaled 27,500 aircraft annually (2019 data). Runway 10/28 has the following load rating: single wheel (S)–16,000 lb. With respect to performance, the primary distresses consisted of medium-severity longitudinal and transverse cracking, as well as low- and medium-severity weathering. There were also over 12,000 square ft of patching on the runway. All the distress deducts were related to climate. A plot of the PCI ratings since the most recent rehabilitation is shown in Figure 40.

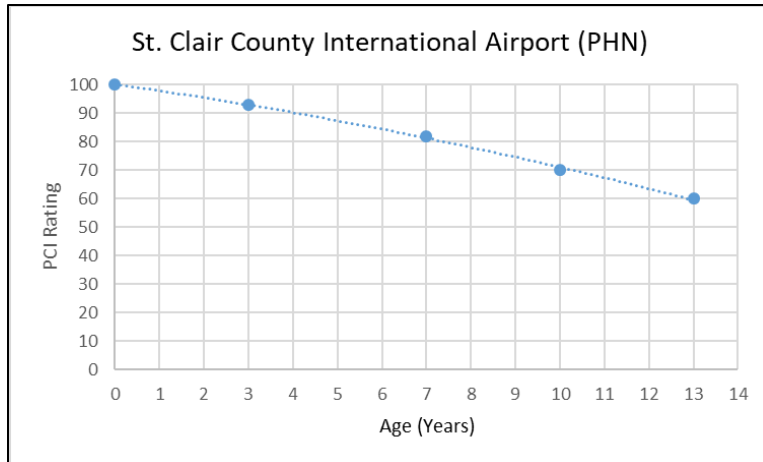

Figure 40. St. Clair County Airport (PHN) Runway 10/28 PCI Ratings

5.5 WISCONSIN

In Wisconsin, 16 projects were included in this evaluation. Ten projects used FAA specifications, while the remaining six projects used the Wisconsin Department of Transportation Standard Specifications for Highway and Structure Construction, either 2011 or 2013 editions, Item 460 “Hot Mix Asphalt Pavement.” However, since these projects were constructed, the Wisconsin Department of Transportation Bureau of Aeronautics has developed Standard Specifications for Airport Construction, which were compared to the current FAA surface source specification (P-401) and are summarized in appendix B.

5.5.1 Prairie du Chien Municipal Airport

Prairie du Chien Municipal Airport (4WI6) is a city-owned, public-use airport located 2 miles southwest of Prairie du Chien in Crawford County, Wisconsin. It is categorized as a basic general aviation facility. Reconstruction of Runway 11/29 was completed in 2012 following the Wisconsin DOT state highway specifications. Reconstruction consisted of the removal of the existing runway pavements, followed by the placement of a 6 in. pulverized asphalt pavement and base, 3 in. HMA pavement (Type E-3) in two layers. The upper lift was 1 1/2 in. of 12.5 NMA mix with a PG 64-28P binder, and the lower lift 1 1/2 in. of 12.5 NMA with a PG 58-28 binder. Aircraft operations total 12,300 aircraft annually (2019 data). Runway 11/29 has the following load rating: single wheel (S)–24,000 lb, and dual wheel (D)–40,000 lb. With respect to performance, Runway Section 10’s primary distresses included low and medium severity longitudinal and transverse cracking, alligator cracking, and weathering with 77% of the distress deducts related to climate and 23% related to load. Runway Section 20’s primary distresses included low- and medium-severity longitudinal and transverse cracking and weathering, and 100% of the distress deducts were related to climate. A plot of the PCI ratings since the most recent rehabilitation is shown in Figure 41.

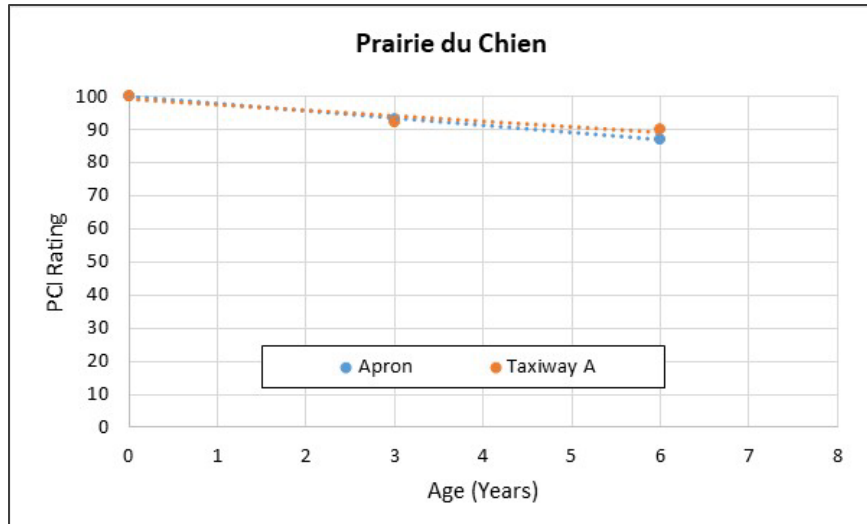

Figure 41. Prairie du Chien Municipal Airport (4WI6) Runway 11/29 PCI Ratings

5.5.2 Fort Atkinson Municipal Airport

The Fort Atkinson Municipal Airport (61C) is a city-owned, public-use airport located 3 miles northeast of Fort Atkinson, a city in Jefferson County, Wisconsin. It is categorized as a local general aviation facility. Reconstruction of Runway 03/21 was completed in 2013 following Wisconsin DOT state highway specifications. The reconstruction work consisted of milling the asphalt surface (variable thickness) and constructing a new bituminous surface in one 2-in. layer of 12.5 mm NMA mix with a PG 64-28P binder. Aircraft operations total 10,900 aircraft annually (2021 data). Runway 18/36 has the following load rating: single wheel (S)–12,000 lb. With respect to field performance, Runway 11/29 Section 10 had a PCI of 79, and the primary distresses included low- and medium-severity longitudinal and transverse cracking, low-severity weathering, and low-severity alligator cracking, with 81% of the distress deducts related to climate and 19% related to load. Runway 03/21 Section 20 had a PCI rating of 88 and the primary distresses included low-severity longitudinal and transverse cracking, medium- and high-severity raveling, and low-severity weathering with all of the distress deducts related to climate. Lastly, Runway 03/21 Section 30 had a PCI rating of 90 with the primary distresses including low-severity longitudinal and transverse cracking, and low-severity weathering, with all of the distress deducts related to climate. A plot of the PCI ratings since the most recent rehabilitation is shown in Figure 42.

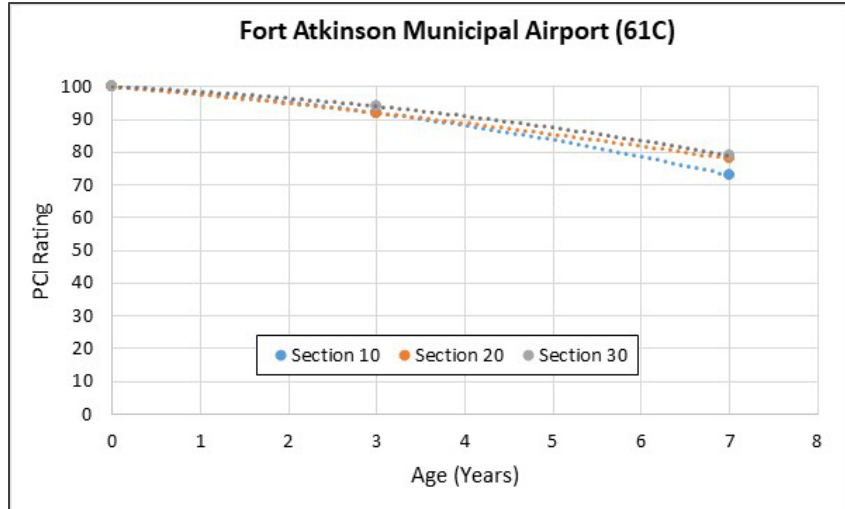

Figure 42. Fort Atkinson Municipal Airport (61C) Runway 03/21 PCI Ratings

5.5.3 Crandon Municipal Airport

The Crandon Municipal Airport (Y55) is a city-owned, public-use airport located 3 miles southwest of Crandon, a city in Forest County, Wisconsin. It is categorized as a basic general aviation facility. Reconstruction of Runway 11/29 was completed in 2012 following Wisconsin DOT state highway specifications. Reconstruction of Runway 11/29 included full pulverization to a depth of 10 in. The new pavement included bituminous surface type E-3 in two lifts: 2-in. binder course (19.0 mm NMAS) with a PG 58-28 binder, and 1.5-in. surface course (12.5 mm NMAS) with a PG 64-28 binder. Runway 11/29 has the following load rating: single wheel (S)–12,000 lb. With respect to performance, Runway 11/29 had a PCI rating of 69, and the primary distresses included low- and medium-severity longitudinal and transverse cracking, and medium- and high-severity weathering with 100% of the distress deducts related to climate. A plot of the PCI ratings since the most recent rehabilitation is shown in Figure 43.

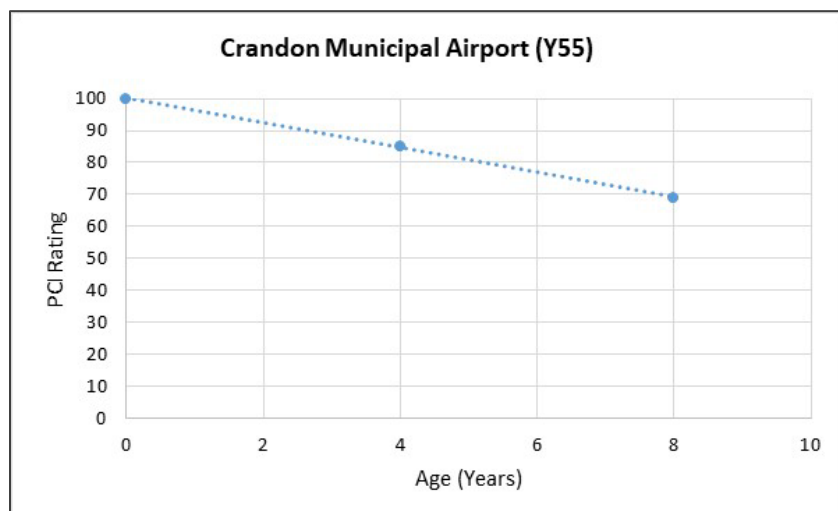

Figure 43. Crandon Municipal Airport (Y55) Runway 11/29 PCI Ratings

5.5.4 Clintonville Municipal Airport

The Clintonville Municipal Airport (CLI) is located 2 miles southeast of Clintonville in Waupaca County, Wisconsin. It is categorized as a local general aviation facility. Reconstruction of Runway 04/22 was completed in 2014 following state highway specifications. The reconstruction work consisted of a new bituminous surface in two lifts. For the lower layer, a 1.25-in., 19.0-mm NMAAS mixture with a PG 58-28 binder was used. For the upper layer, 1.75-in. of 12.5-mm mixture with a PG 64-28P binder was used. Aircraft operations total 11,500 aircraft annually (2020 data). Runway 04/22 has the following load rating: single wheel (S)–30,000 lb and dual wheel (D)–55,000 lb. In terms of field performance, Runway 04/22 had a PCI rating of 84 with the primary distresses including low- and medium-severity longitudinal and transverse cracking, and low-severity weathering, with all the distress deducts related to climate. A plot of the PCI ratings since the most recent rehabilitation is shown in Figure 44.

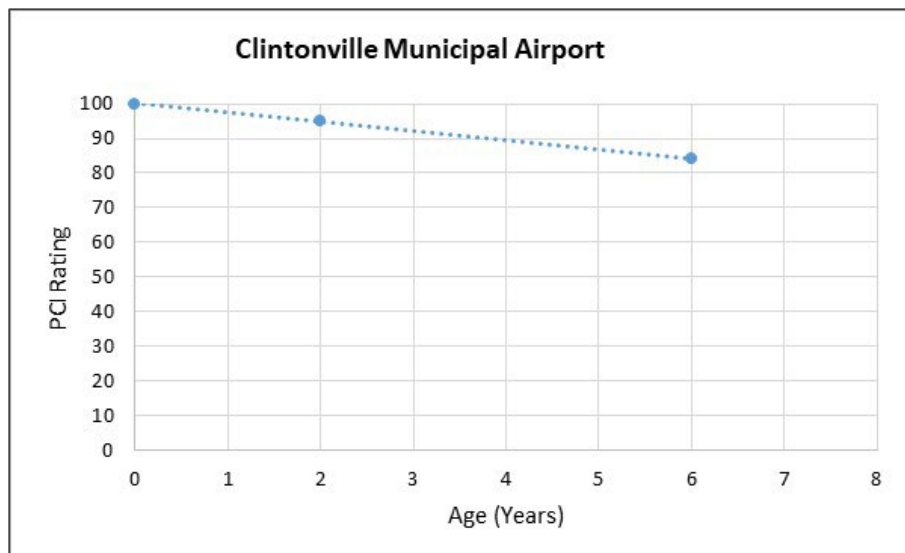

Figure 44. Clintonville Municipal Airport (CLI) Runway 04/22 PCI Ratings

5.5.5 Oconto J. Douglas Bake Municipal Airport

The Oconto J. Douglas Bake Municipal Airport (OCQ) is a public-use airport located 2 miles southwest of Oconto, a city in Oconto County, Wisconsin. It is categorized as a local general aviation facility. Reconstruction of Runway 11/29 was completed in 2017 following Wisconsin DOT state highway specifications. The reconstruction work consisted of milling to a variable thickness, followed by the construction of a new bituminous surface in two lifts, 1.75 in. each, with the lower layer using a PG 58-28S binder and the upper layer using a PG 58-34S binder. Aircraft operations total 11,620 aircraft annually (2018 data). Runway 11/29 has the following load rating: single wheel (S)–40,000 lb, dual wheel (D)–55,000 lb; and two dual wheels in tandem (2D)–90,000 lb. With respect to performance, Runway 11/29’s primary distress included low-severity longitudinal and transverse cracking and low-severity weathering.

5.5.6 Amery Municipal Airport

The Amery Municipal Airport (AHH) is a city-owned, public-use airport located 2 miles south of the central business district of Amery, a city in Polk County, Wisconsin. It is categorized as a local general aviation facility. The most recent rehabilitation occurred in 2015 using FAA specifications where Runway 18/36 was reconstructed. Plans for the project were not available. The overall airport traffic operations totaled 13,900 aircraft annually (2020 data). Runway 18/36 has the following load rating: single wheel (S)–12,500 lb. With respect to performance, the primary distresses include low- and medium-severity longitudinal and transverse cracking. All the distress deducts are climate related. A plot of the PCI ratings since the most recent rehabilitation is shown in Figure 45.

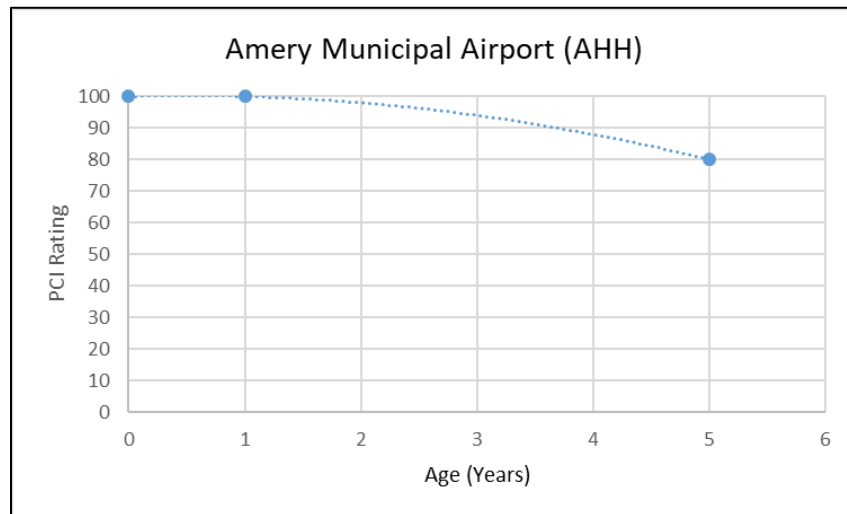

Figure 45. Amery Municipal Airport (AHH) Runway 18/36 PCI Ratings

5.5.7 Baraboo-Wisconsin Dells Regional

The Baraboo-Wisconsin Dells Regional (DLL) is categorized as a regional general aviation facility and is located 3 miles northwest of Baraboo in Sauk County, Wisconsin. Reconstruction of the apron was completed in 2011 using FAA specifications. The plans included the reconstruction of a new bituminous surface in two lifts, a 2.25-in. binder course (19.0-mm NMAS) with a PG 58-28 binder, and a 1.75-in. surface course (12.5-mm NMAS) with a PG 64-28P binder. Aircraft operations total 30,000 aircraft annually (2020–2021 data). Runway 14/32 has the following load rating: single wheel (S)–20,000 lb, and dual wheel (D)–55,000 lb. With respect to performance, the primary distresses include low- and medium-severity longitudinal and transverse cracking, and weathering. All the distress deducts were related to climate. The plot of PCI ratings since the most recent rehabilitation is presented in Figure 46.

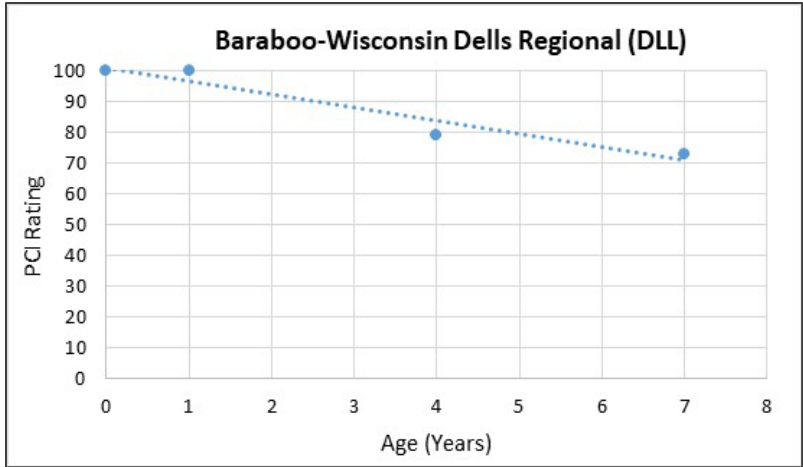

Figure 46. Baraboo-Wisconsin Dells Regional (DLL) Apron PCI Ratings

5.5.8 Bloyer Field

Bloyer Field (Y72) is a city-owned, public-use airport located 1 mile east of Tomah, a city in Monroe County, Wisconsin. The airport provides general aviation services. Reconstruction of the apron and Taxiway A was completed in 2014 using FAA specifications. The reconstruction consisted of milling 2–4 in. of bituminous surface and regrading and compacting the existing base course or new base as necessary. A new surface was placed in two lifts, 1.5 in. each (12.5-in. NMAS) with a PG 58-28 binder. Aircraft operations total 7,150 aircraft annually (ADIP, 2021). Load ratings for the associated runway (Runway 07/25) were not available. With respect to performance, for the apron, the primary distresses included low- and medium-severity longitudinal and transverse cracking, raveling, and weathering with 100% of the distress deducts related to climate. For Taxiway A, the primary distresses included low- and medium-severity longitudinal and transverse cracking with all the distress deducts related to climate. The plot of PCI ratings since the most recent rehabilitation for the apron and Taxiway A are shown in Figure 47.

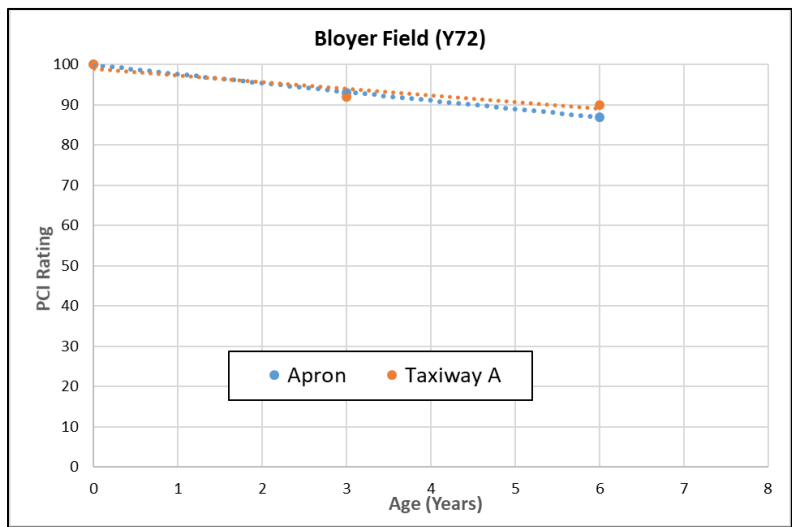

Figure 47. Bloyer Field Apron and Taxiway A PCI Ratings

5.5.9 Cumberland Municipal Airport

The Cumberland Municipal Airport (UBE) is a city-owned, public-use airport located 3 miles southeast of Cumberland, a city in Barron County, Wisconsin. The airport is categorized as a local general aviation facility. The rehabilitation of Runway 09/27, Taxiway E, and the apron was completed in 2015. The rehabilitation work was as follows: for Runway 09/27 and Taxiway E, the work consisted of milling 2.5 in. of HMA followed by the placement of two layers of HMA pavement Type E-1 (12.5 mm NMAS), each at a thickness of 1.75 in. For the apron, the project consisted of milling 3 in. of HMA followed by the placement of two 1.75-in. layers of HMA pavement Type E-3 (12.5 mm NMAS). Aircraft operations total 10,900 aircraft annually (ADIP 2021). Load ratings for the associated runways (Runways 09/27 and 18/36) were not available.

With respect to performance, the primary distresses for Runway 09/27 include low- and medium-severity longitudinal and transverse cracking, and 100% of the distress deducts were related to climate. For the apron, the primary distresses included alligator cracking, and low- and medium-severity longitudinal and transverse cracking, with 21% of the distress deducts related to load and 79% related to climate. For Taxiway E, distresses included low- and medium-severity longitudinal and transverse cracking, and all the distress deducts were related to climate. The plots of PCI ratings since the most recent rehabilitation for Runway 09/27, Taxiway E, and the apron are shown in Figure 48.

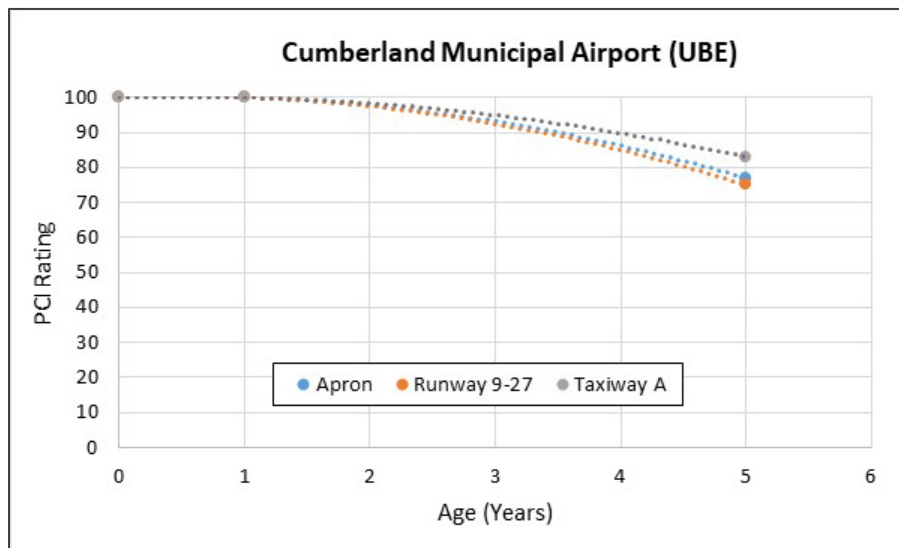

Figure 48. Cumberland Municipal Airport Apron, Runway 09/27, and Taxiway E PCI Ratings

5.5.10 East Troy Municipal Airport

The East Troy Municipal Airport (57C) is a village-owned, public-use airport located 2 miles northeast of East Troy, a village in Walworth County, Wisconsin. It is categorized as a local general aviation facility. Reconstruction of Runway 08/26 and Taxiway B was completed in 2014 and 2003 following FAA and Wisconsin DOT state highway specifications, respectively. The reconstruction work of Runway 08/26 consisted of milling the existing asphalt pavement and placement of new asphaltic concrete pavement in two lifts. These were 2.25 in. for the lower course

(19.0-mm NMAS) and 1.75 in. for the upper course (12.5-mm NMAS). No construction information was available for Taxiway B. Aircraft operations total 41,000 aircraft annually (ADIP 2021). Runway 08/26 has the following load ratings: single wheel (S)–20,000 lb. In terms of performance, Runway 08/26’s primary distresses include low-severity longitudinal and transverse cracking and weathering, and 100% of the distress deducts were related to climate. For Taxiway B, the primary distresses included medium-severity alligator cracking, low- and medium-severity longitudinal and transverse cracking, and low- and medium-severity weathering, with 33% of the distress deducts related to load and 67% related to climate. The plot of PCI ratings since the most recent rehabilitation for Runway 08/26 and Taxiway B are shown in Figures 49 and 50.

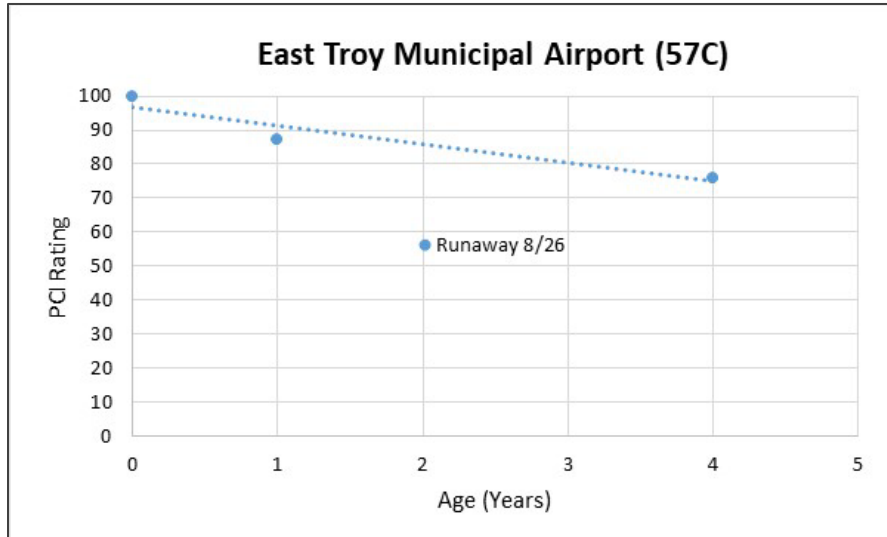

Figure 49. East Troy Municipal Airport Runway 08/26 PCI Ratings

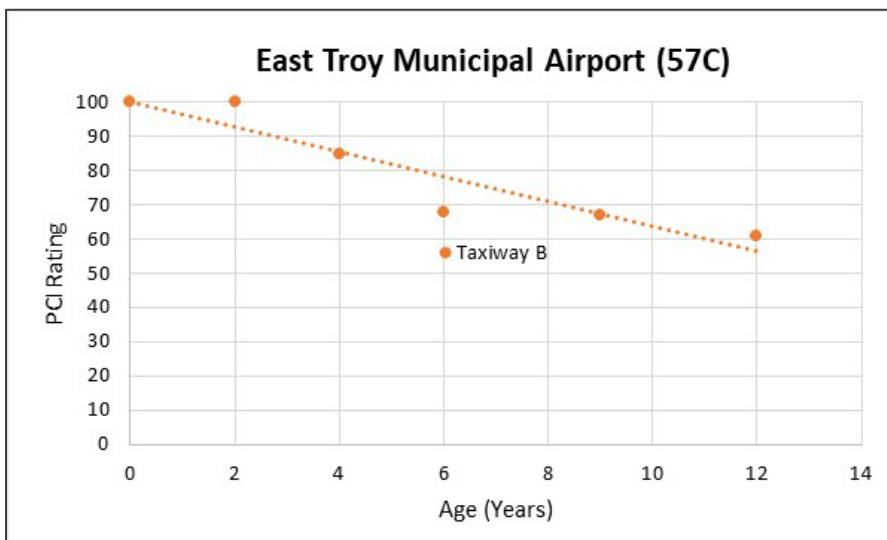

Figure 50. East Troy Municipal Airport Taxiway B PCI Ratings

5.5.11 Fond du Lac County Airport

The Fond du Lac County Airport (FLD) is a county-owned, public-use airport located 1 mile west of Fond du Lac, a city in Fond du Lac County, Wisconsin. It is categorized as a regional general aviation facility. Reconstruction of the apron was completed in 2007 following FAA specifications. No construction information was available. Aircraft operations total 63,200 aircraft annually (2020 data). In terms of performance, the apron's primary distresses include low- and medium-severity longitudinal and transverse cracking, moderate and high weathering, and low-severity depression, with 96% of the distress deducts related to climate and 4% to other distresses. The plot of PCI ratings since the most recent rehabilitation is shown in Figure 51.

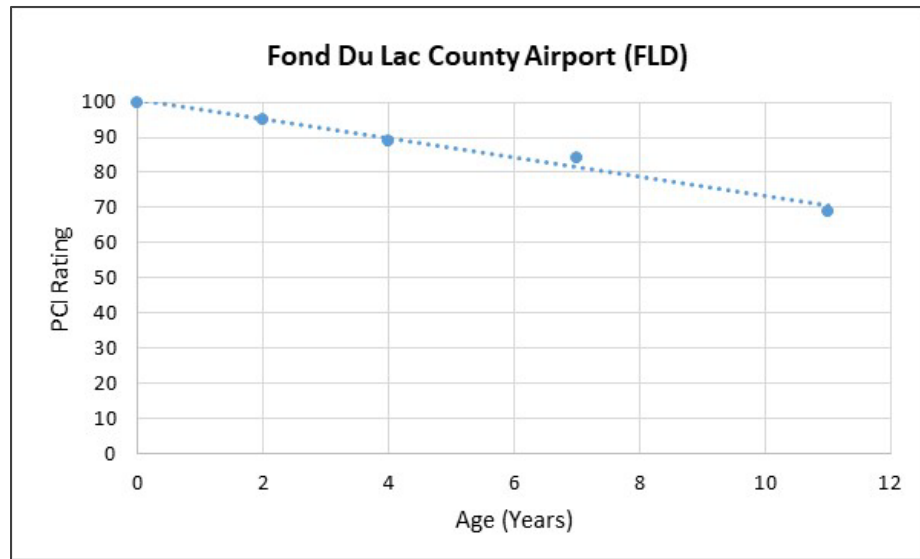

Figure 51. Fond Du Lac County Airport Apron PCI Ratings

5.5.12 Park Falls Municipal

The Park Falls Municipal (PFK) airport is a city-owned public airport located 2 nautical miles northeast of Park Falls, a city in Price County, Wisconsin. It is categorized as a basic general aviation facility. Reconstruction of Runway 18/36 was completed in 2015 following FAA specifications. The reconstruction consisted of milling 2 in. of asphaltic pavement followed by the placement of two layers of HMA pavement Type E-3, each at a thickness of 1.5 in. with PG 64-34 binder. The binder layer was a 12.5-mm NMAS mix, and the surface was a 9.5-mm NMAS mix. Aircraft operations total 6,750 aircraft annually (2020 data). Runway 18/36 has the following load rating: single wheel (S)–20,000 lb. With respect to performance, the primary distresses include low- and medium-severity longitudinal and transverse cracking, and weathering. All distresses are related to climate. The plot of the PCI ratings since the most recent rehabilitation is shown in Figure 52.

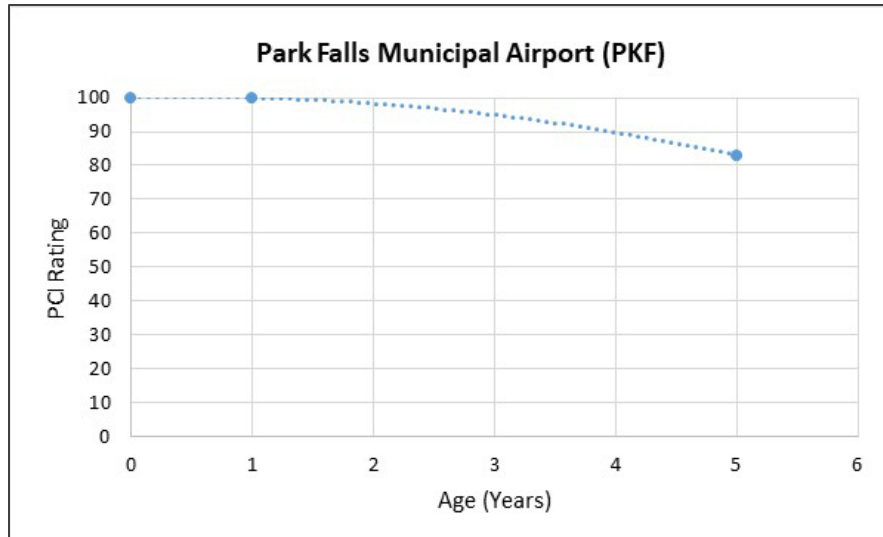

Figure 52. Park Falls Municipal Airport Runway 18/36 PCI Ratings

6. SPECIFICATIONS FOR ASPHALT HIGHWAY AND AIRPORT PAVEMENTS

Because of the differences between highway and airport pavements, construction requirements for airport pavement projects can be different than those of highway pavement projects. To identify significant differences between the two types of specifications, the state asphalt specifications (which includes both highway and airport specifications) that were used for airfield projects documented in this report were compared to current FAA asphalt pavement specifications. For Indiana—because all evaluated projects used FAA specifications—a review was made of their most current asphalt specifications for highways. For Wisconsin—because the projects included in this report were specified using different editions of the state highway specifications—the comparison is based on the current Standard Specification for Airport Construction. The FAA specifications reviewed were the most current (2018). The specifications reviewed include the following:

- FAA: *Standard Specifications for Construction of Airports*, AC 150/5370-10H (Item P-401 Asphalt Mix Pavement). Date: 12/21/2018.
- Georgia: *Standard Specifications: Construction of Transportation Systems*, published by the Georgia Department of Transportation, Sections 400 and 800. Date: 2013.
- Illinois: *Illinois Standard Specifications for Construction of Airports*, (Item 401 Bituminous Surface Course–Superpave). Illinois Department of Transportation, Division of Aeronautics. Date: 4/1/2012.
- Indiana: *Indiana Department of Transportation Standard Specifications*, Section 401, 2020 Edition.
- Michigan: *Standard Specifications (P-411 Plant Mix Bituminous Pavements)*. Michigan Department of Transportation, Airports Division. Date: 10/10/2007.

- Wisconsin: Standard Specifications for Airport Construction, 2021 Edition.

6.1 AGGREGATE REQUIREMENTS

A summary of coarse and fine aggregate requirements is shown in Tables 8 and 9.

Table 8. Coarse Aggregate Requirements

Material Test	FAA P-401	GDOT	ILDOT	Indiana DOT	Michigan DOT	Wisconsin DOT
Resistance to abrasion (% maximum loss)	40	40	40	40	40	40
Soundness (% maximum Loss)	12 (sodium); 18 (magnesium)	15 (magnesium)	15 (sodium)	12 (sodium)	NA	12 (sodium); 18 (magnesium)
Clay lumps & friable particles (% maximum)	0.3	NA	See requirements below	1.0	NA	1.0
Fractured faces	50% with at least two fractured faces and 65% with at least one fractured face	Minimum 85% one or more fractured faces	NA	Limits in AASHTO M 325	40	50% with at least two fractured faces and 65% with at least one fractured face
Flat & elongated (%)	≤ 8 (5:1 ratio)	≤ 10 (5:1 ratio)	NA	≤ 10 (5:1 ratio)	≤ 8 (5:1 ratio)	≤ 10 (5:1 ratio)
Bulk density of slag (pcf)	≥ 70	NA	NA	NA	≥ 70	≥ 70
Clay lumps	NA	NA	0.5	NA	NA	NA
Shale	NA	NA	2.0	NA	NA	NA
Soft & unsound particles %	NA	NA	6.0	NA	5	NA
Other deleterious %	NA	2.0	2.0	NA	NA	NA
Total deleterious	NA	NA	6.0	NA	NA	NA
Mica schist maximum %	NA	10	NA	NA	NA	NA
Glassy particles (slag) maximum %	NA	30	NA	NA	NA	NA

NA = Not applicable

Table 9. Fine Aggregate Requirements

Material Test	FAA P-401	Georgia DOT	Illinois DOT	Indiana DOT	Michigan DOT	Wisconsin DOT
Liquid limit	25 maximum	NA	NA	NA	25 maximum	25 maximum
Plasticity index	4 maximum	NA	NA	NA	6 maximum	3 maximum fine aggregate; 4 maximum mineral filler
Soundness (maximum % loss)	10 (sodium); 15 (magnesium)	NA	15 (sodium)	10 (sodium)	NA	10 (sodium); 15 (magnesium)
Clay Lumps & Friable particles (Maximum %)	0.3	NA	3.0	NA	NA	1%
Sand equivalent (Minimum %)	45	Limestones \geq 28 Granites \geq 40 Natural sand \geq 20 Blended sand \geq 25	NA	Limits in AASHTO M 325	NA	45
Maximum Sand Content	15%	20% ¹	NA	NA	Sand ratio on mix design ²	15%
Fine Aggregate Angularity	NA	NA	NA	Limits in AASHTO M 325	Tested, no limits	NA
Organic Impurities Check	NA	NA	NA	NA	NA	NA
Shale	NA	NA	3.0	NA	NA	NA
Clay Lumps	NA	NA	3.0	NA	NA	NA
Coal, Lignite and Shells	NA	NA	3.0	NA	NA	NA
Conglomerate	NA	NA	3.0	NA	NA	NA
Mica	NA	35 % maximum	NA	NA	NA	NA

Note 1: GDOT mix design requirements limit local sand to a maximum of 20%.

Note 2: Sand ratio is defined as no more than 50% of the material passing the No. 4 sieve is allowed to pass the No. 30 sieve.

6.1.1 Summary of Differences

One area where state highway agency specifications may be more robust is with respect to some of the more localized requirements. For example, the ILDOT coarse aggregate specification limits shale to 1.0%, while the FAA specification does not address shale. This is more than likely due to the ILDOT having experienced previous issues with excess shale in that region that the FAA is not aware of. Conversely, several states have more relaxed requirements on aggregate as compared to FAA requirements. For example, the FAA specification limits the amount of natural sand to 15% maximum, while most of the states included in this study do not (the Michigan DOT does include a sand ratio, which is similar).

6.2 ASPHALT BINDER

6.2.1 Federal Aviation Administration

PG binder meeting the requirements of ASTM D6084 (2006) is required with the additional requirement of Elastic Recovery. Prior to grade bumping, the PG grade must be consistent with the applicable state DOT requirements. Grade bumping is required based on Aircraft Gross Weight as well as pavement areas with slow or stationary aircraft.

6.2.2 Georgia Department of Transportation

PG 67-22 is the standard grade for all mixtures. For mixtures containing RAP, the engineer determines the PG grade. PG 76-22 is required as specified by the Design Engineer. Only SBS or SB can be used as a modifier with neat asphalt to produce the PG 76-22. Air blown asphalts are not permitted.

6.2.3 Illinois Department of Transportation

PG 64-22 is to be used for all HMA produced unless otherwise specified. The asphalt binder must meet the requirements of AASHTO M 320, Table 1 (AASHTO M 320, 2011). If necessary, elastomers must be added to the base asphalt binder to achieve the specified PG and must be either a SB di-block or tri-block copolymer, without oil extension, or a SB rubber. Air blown asphalts, acid modification, and other modifiers are not allowed. Asphalt modification at hot-mix asphalt plants is not allowed. No provisions for grade bumping or PG+ testing are specified.

6.2.4 Indiana Department of Transportation

PG 58-28 and PG 64-28 binders are required for mixtures containing greater than 15% RAP. The following PG binders are required for mixes without RAP: PG binders PG 64-22, 70-22, and 76-22.

6.2.5 Michigan Department of Transportation

The types of binders used are specified in the plans or other contract documents. Specified binder grades include PG 58-22, 58-28, 58-34, 64-22, 64-28, and 64-34. Binder requirements are as specified in AASHTO M 320. No provisions for grade bumping are specified.

6.2.6 Wisconsin Department of Transportation

Asphalt binders are supplied and tested in conformance with the Departments' Combined State Binder Group Method of Acceptance for Asphalt Binders, and AASHTO M 332 (AASHTO M 332, 2012).

6.2.7 Summary of Differences

In general, the binder requirements for the FAA specifications and highway specifications are all very similar, with the exception that the current FAA specifications now provide guidance on grade bumping and contain a provision for PG+ testing (elastic recovery). It should be noted that the provisions for PG+ testing did not appear in the P-401 specifications until 2014, while the provisions for grade bumping date back as far as 2009.

6.3 MIX DESIGN

6.3.1 Federal Aviation Administration

The laboratory used to develop the JMF must possess a current certificate of accreditation, listing ASTM D3666 from a national accrediting authority. The asphalt mixture must be designed using procedures contained in the AI's *MS-2 Mix Design Manual*, 7th Edition. The project designer selects the method for mix design, either the Marshall Method (ASTM D6926, 2012) or the Gyrotory Method (ASTM D6925, 2012). Fifty blows or gyrations are specified for airports serving aircraft 60,000 lb or less. Design criteria include:

- Three NMAS gradations: 19.0 mm, 12.5 mm, or 9.5 mm (9.5 mm allowed for leveling only).
- Design air voids equal to 3.5%.
- Minimum VMA: 19.0 mm—14.0%, 12.5 mm—15.0%, 9.5 mm—16.0%
- $TSR \geq 80\%$.
- RAP can either be excluded by the project designer or used with binder grade adjustments (0–20%: no adjustment; > 20%–30%: one grade softer).
- APA (or Hamburg) is required on projects with aircraft > 60,000 lb.

6.3.2 Georgia Department of Transportation

The Superpave design method is used following AASHTO TP 4 and PP 2 (updated to T 312 and R 30, respectively). Designs must be performed by qualified and approved laboratories and technicians. One-percent hydrated lime is required in all mixtures. Local sand content is limited. Design criteria include:

- Four NMAS gradations: 25.0 mm, 19.0 mm, 12.5 mm, 9.5 mm.

- N_{design} levels of 50, 75, 100, and 125.
- Design air voids equal to 4.0%.
- Minimum VMA: 25.0 mm—12.0%, 19.0 mm—13.0%, 12.5 mm—14.0%, 9.5 mm—15.0%. (Note that GDOT uses effective specific gravity of the aggregate to calculate VMA.)
- APA rutting: N_{design} 75–6 mm maximum; N_{design} 100/125–5 mm maximum.
- TSR 80% minimum.

6.3.3 Illinois Department of Transportation

The Superpave design method is used following the AI's Superpave Series SP-2 (now MS-2). Design criteria include:

- One NMAS gradation, a 9.5-mm coarse graded surface mix.
- N_{design} is 30 gyrations for all applications (< 60,000-lb load).
- The target air voids are determined by the ILDOT Division of Aeronautics on a case-by-case basis within the range of 2%–4%.
- RAP material is permitted only in base courses (Item 403), not surface courses (Item 401).
- ILDOT also specifies VFA and does not specify VMA.

6.3.4 Indiana Department of Transportation

The Superpave design method is used following modified AASHTO M 323 criteria.

6.3.5 Michigan Department of Transportation

The testing laboratory used to develop the JMF must meet the requirements of ASTM D 3666 (2016) or be a certified laboratory under MDOT's Bituminous Laboratory Certification Program. For pavements with aircraft gross weights < 60,000 lb and tire pressure < 100 psi, the Marshall Mix Design method is used in accordance with AI's MS-2.

- Marshall compaction is set at 50 blows.
- Design air void content is 2.5%.
- NMAS of the mixture is 12.5 mm.
- Minimum VMA is 14.5%.
- Minimum stability is 1000 lb.

- Flow is 8–18.
- RAP is not permitted unless stated otherwise in the contract.

6.3.6 Wisconsin Department of Transportation

Asphalt mixes are designed using procedures contained in Asphalt Institute *MS-2 Mix Design Manual*, 7th Edition. Samples are prepared and compacted using the gyratory compactor, in accordance with ASTM D6925-12. The mix design and JMF must be prepared by an accredited laboratory and must meet the following requirements:

- 75 gyrations (aircraft gross weight of < 60,000 lb)
- Design air voids equal to 3.5%
- Tensile strength ratio (TSR) not less than 80 at a saturation of 70%–80%
- HWTT less than 12.5 mm at 7,500 passes for S-traffic, 10,000 passes for H-traffic, at 15,000 passes for V-traffic, and 20,000 passes for E-traffic
- VMA: 12.5 mm-14%, 9.5 mm-15%, and 4.75 mm - 16%
- RAP can be used only for shoulder surface course mixes and for any lower layers, limited to 20% maximum.

6.3.7 Summary of Differences

The FAA specification has minimum VMA requirements that are generally higher than the state highway specifications. This coupled with the FAA design air void target of 3.5% results in a volume of effective binder (V_{be}) that is typically higher for FAA mixes. For example, comparing a 12.5-mm FAA mix with a 12.5-mm Indiana Department of Transportation (INDOT) mix, the minimum V_{be} for an FAA mix is 11.5%, whereas an INDOT mix requires a minimum V_{be} of 10.0%. This difference would likely mean a 0.6% to 0.7% lower asphalt content by mass for an INDOT mix design. Because asphalt content is closely associated with pavement durability and cracking resistance, this is expected to have a significant impact on the serviceability and life of the airfield pavement.

6.4 QUALITY CONTROL

6.4.1 Federal Aviation Administration

The contractor must have an approved QC Program. Minimum testing includes:

- Binder content (2/day)
- Extracted aggregate gradation (2/day)
- Moisture content of aggregate and asphalt mixture (1/day)

- Temperatures (4/day)
- In-place density and smoothness (as necessary)
- Grade measurements
- VMA (1/day)
- Must maintain control charts with action and suspension limits.

6.4.2 Georgia Department of Transportation

The contractor must have an approved QC Plan, and qualified laboratory and testing personnel. Lot size is 1 day's production, subplot is 500 tons. Minimum testing includes:

- Binder content and extracted gradation (1/sublot)
- Mixture temperature (1/sublot)
- Density

6.4.3 Illinois Department of Transportation

The contractor must have an approved Contractor Quality Control Program. Minimum testing that includes aggregate gradations (stockpiles) one per week. Mixture testing (1/1000 tons) includes:

- Binder content and gradation
- Maximum specific gravity
- Bulk specific gravity
- Air voids

Control limits (including individual tests and moving average of 4) are established for gradation, binder content, bulk specific gravity (G_{mb}), and maximum specific gravity (G_{mm}).

6.4.4 Indiana Department of Transportation

The contractor must have an approved QC plan, and qualified laboratory and testing personnel. The subplot size is 600 tons. Minimum testing includes binder content and air voids at N_{design} .

6.4.5 Michigan Department of Transportation

The contractor must perform QC sampling, testing, and inspection during all phases of the work and perform them at a rate sufficient to ensure that the work conforms to the contract requirements. This includes:

- Binder content
- Aggregate gradation
- Temperature
- Aggregate moisture
- Field compaction
- Smoothness

No specific requirements (testing frequency, control charts, control limits, etc.) are included.

6.4.6 Wisconsin Department of Transportation

The contractor must have an approved Contractor Quality Control Program.

6.4.7 Summary of Differences

The FAA specifications are generally more detailed on QC requirements than state highway specifications, and typically require additional testing. Testing includes:

- Binder content (2 tests/lot)
- Aggregate gradation (2/lot)
- Moisture content of aggregate and asphalt mixture (1/lot)
- Temperature (4/lot)
- In-place density as necessary to ensure density specified is being achieved
- Smoothness (daily)
- Grade (daily)

Also, contractors are required to maintain control charts for individual measurements and range for aggregate gradation, asphalt content, and VMA.

6.5 ACCEPTANCE

6.5.1 Federal Aviation Administration

Testing must be performed in an accredited laboratory (ASTM D3666-16) and performed by qualified personnel. Lot size is a one-day's production divided into sublots of 400 to 600 tons. Acceptance tests include air voids, in-place asphalt mat and joint density (5-in. cores), grade, and profilograph roughness. Acceptance is based on a PWL formula with upper and lower limits for

air voids (2.0% and 5.0%); lower limits for surface course mat density (92.8%), base course mat density (91.8%), and joint density (90.5%); grade and roughness. PWL of 90% or greater is acceptable. Payment is based on mat density and air voids.

6.5.2 Georgia Department of Transportation

Laboratory testing is performed in an accredited laboratory by qualified personnel. Lot size is one-day's production. The tests performed are asphalt content, gradation (3/8, No. 4 and No. 8 sieves), in-place air voids, and smoothness. Maximum pavement mean air voids are 7.8% (92.2% G_{mm}). Acceptance is based on pavement mean air voids (density); pay factors for binder content; 3/8, No. 4 and No. 8 sieves; and smoothness index.

6.5.3 Illinois Department of Transportation

For projects less than 2,500 tons, acceptance is based on density of the compacted mat, with a density range of 93.0%–99.0% of G_{mm} . Two random nuclear density tests are run for each 500 tons placed. For projects greater than 2,500 tons, acceptance is based on density of the compacted mat, with a density range of 93.0%–99.0% of G_{mm} . A lot consists of four 500-ton sublots. One density sample (two 6-in. diameter cores) is randomly selected per subplot from the mat. Acceptance is based on a PWL quality measure with a PWL of 90 or greater resulting in 100% pay. Mixture samples are used for control purposes only, not for acceptance.

6.5.4 Indiana Department of Transportation

Density acceptance by cores is based on samples obtained from two random locations selected by the engineer within each subplot. The subplot size is 600 tons. A composite pay factor for binder content, air voids at N_{design} , VMA at N_{design} , and field density is utilized.

6.5.5 Michigan Department of Transportation

Binder content and gradation are determined by the engineer and used as a pass/fail control method. Density (in-place air voids) is evaluated on a per lot basis. A lot consists of a day's production up to 2,000 tons. One sample is taken per subplot (500 tons) randomly. The acceptable in-place voids range is 1.0%–7.0%. A PWL quality measure is used with a PWL of 90 or greater resulting in 100% pay.

6.5.6 Wisconsin Department of Transportation

Testing must be performed in an accredited laboratory (ASTM D3666-16). A standard lot is equal to 1 day's production; if the daily tonnage exceeds 4,000 tons, the lot size is 1/2 day's production. Acceptance tests includes air voids, in-place mat density, joint density, and profilograph roughness. Acceptance is based on a PWL formula with upper and lower limits for air voids (2.0% and 5.0%); lower limits for surface course mat density (92.8%), base course mat density (92.0%), and joint density (90.5%). Payment for a lot of HMA meeting all acceptance criteria is made based on results of tests for mat density and air voids.

6.5.7 Summary of Differences

The acceptance criteria are similar regarding laboratory air voids and in-place density requirements, except that GDOT does not use laboratory air voids for as-constructed acceptance criteria. In general, the Wisconsin requirements are similar to FAA requirements.

6.6 CONSTRUCTION

6.6.1 Federal Aviation Administration

The use of an MTV is optional. Tack must be an undiluted emulsified asphalt meeting the requirements of ASTM D3628-15, with an application rate (residual) of 0.04–0.08 gpsy for milled surfaces. Cold longitudinal joints must be cut back a maximum of 3 in.

6.6.2 Georgia Department of Transportation

An MTV is required if more than 6,000 vehicles are in use per day, and project length is greater than 3,000 ft. The vertical face of the longitudinal joint must be cleaned and tacked before placing adjoining material. Tack material can be PG 58-22, PG 64-22, PG 67-22, or CRS-2h or CRS-3. Application rate as determined by the engineer is within the range of 0.04–0.06 gpsy. Longitudinal joints must be constructed so that the joint is smooth, well-sealed, and bonded.

6.6.3 Illinois Department of Transportation

The use of an MTV is not required. Allowable tack materials are SS-1, SS-1h, SS-1hP, CSS-1, CSS-1h, HFE-90, or RC-70; emulsions are diluted at a 50/50 rate. Application rate is 0.02 to 0.06 gpsy residual for emulsions. There is no mandatory cutback on longitudinal joints. Minimum joint density required is 90% based on two cores cut per 2,500 tons.

6.6.4 Indiana Department of Transportation

Tack material can be either a medium-breaking, comparatively low-penetration type emulsion or a polymerized modified asphalt emulsion. Tack material can also be PG 64-22. Application rate as determined by the engineer within the range of 0.03–0.08 gpsy.

6.6.5 Michigan Department of Transportation:

Tack coat information was not available. There is no requirement to use an MTV.

6.6.6 Wisconsin Department of Transportation-Specification P 401

Plants used for the preparation of HMA shall conform to the requirements of AASHTO M 156-13.

6.6.7 Summary of Differences

Primary differences are that the state specifications do not have a requirement to cut back the longitudinal joint and are inconsistent on the requirement for using an MTV.

7. FINDINGS AND DISCUSSION

The PCI ratings for each of the projects were compiled and summarized based on the type of specifications used (FAA versus state highway). A plot of the data was then made of the PCI ratings by age for both FAA and state highways, as shown in Figure 53.

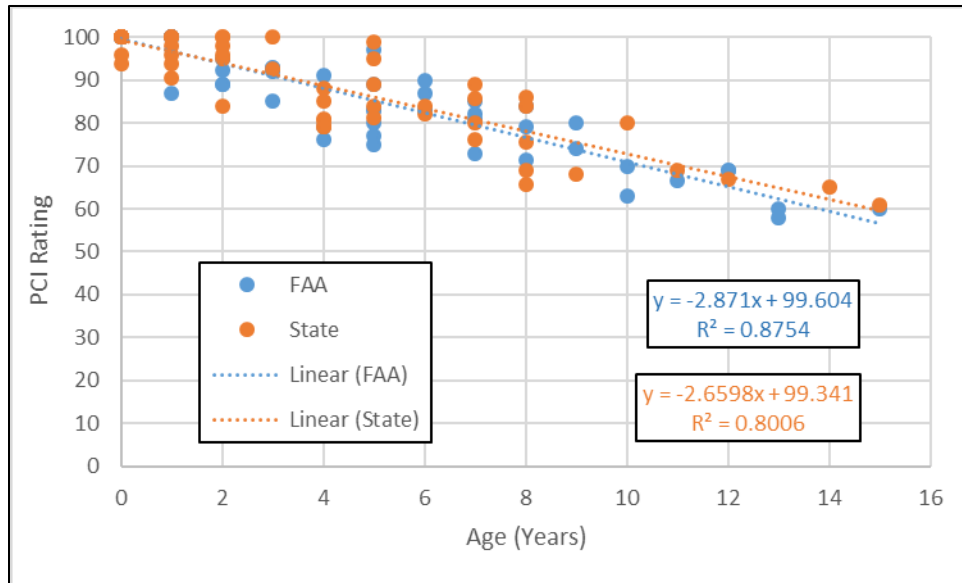

Figure 53. Plot of PCI Ratings by Age

PCI versus age for both types of specifications were fit with least-squares linear regression equations. Both regressions show a good fit with coefficients of determination (R^2) of 0.8754 and 0.8006 for the FAA and the state data sets, respectively. The regression equations indicate a PCI rating of approximately 60 at year 14 for both types of specifications. The age coefficient (slope) for the regression equations is similar: -2.871 versus -2.6598 for the FAA and state regression equations, respectively. An analysis of variance (ANOVA) was then performed to determine if the regression equations were statistically different. The age coefficient for FAA specifications data is the smaller (more negative), possibly indicating a slightly faster rate of deterioration than projects that used state specifications. However, the ANOVA results provided in Table 10 show that the main effect of Spec is not significant ($p = 0.824$), indicating that the effect of specification type is not statistically significant. Therefore, there is insufficient evidence to conclude that the regression equations are different. For the purpose of this study, this indicates that the type of specifications used to build the selected pavements did not affect performance.

Table 10. Analysis of Variance

Source	Degrees of Freedom	Adjusted Sum of Squares	Adjusted Mean of Squares	F-Value	P-Value
Regression	3	15524.5	5174.84	222.24	0.000
Age	1	9039.1	9039.12	388.2	0.000
Spec	1	1.2	1.16	0.05	0.824

Source	Degrees of Freedom	Adjusted Sum of Squares	Adjusted Mean of Squares	F-Value	P-Value
Age × spec	1	22.2	22.16	0.95	0.331
Error	124	2887.3	23.28		
Lack-of-fit	26	924.6	35.56	1.78	0.023
Pure error	98	1962.7	20.03		
Total	127	18411.8			

To determine if the type of specification impacted the types of distresses encountered, the percentage of distress deducts was summarized for each of the projects. The distress deducts were characterized into three general categories:

1. Load: Alligator cracking, corrugation, rutting, and shoving
2. Climate: Block cracking, joint reflective cracking, longitudinal and transverse cracking, raveling, and weathering
3. Other: Bleeding, depression, jet-blast erosion, oil spillage, polished aggregate, patching and utility cut patch, slippage cracking, and swell distress

Table 11 summarizes the projects based on the type of distress deducts (identified from the most recent inspection report) and specification. For both types of specifications, climate-related distresses were the predominant mode of distress on all projects, with longitudinal and transverse cracking being the most prevalent. With respect to load-related distresses, only 3 of the 22 FAA projects had load-related distresses. The greatest amount of load-related distress was an apron on Cumberland Municipal Airport, where 21% of the deducts were attributed to low-severity alligator cracking. Similarly, only 5 of the 19 projects that used state specifications had load-related distresses. The greatest amount of load-related distress was observed on Taxiway B at the East Troy Municipal Airport, where 33% of the distress deducts were attributed to medium-severity alligator cracking. A detailed summary of the distresses for all projects can be found in appendix C.

Because most of the distresses encountered on airport projects are climate related (specifically longitudinal and transverse cracking, and weathering), it is important that efforts be made to develop and use specifications that will increase the asphalt pavement’s cracking resistance and durability. This can be accomplished primarily by improvements in construction and mix design specifications.

It is presumed that longitudinal cracking observed on the airfield pavements was mostly associated with longitudinal joints. The resistance of these joints to deterioration is primarily a construction issue. In the last decade or so, attempts to improve joint performance for highways and airfields has focused on improving density of the material at the joint. In 2014, FAA specifications began requiring the cutting back of joints to remove lower density material on the cold side, if the joint had been exposed for more than 4 hours or had cooled to less than 175 °F. (FAA, 2014). (Prior to 2014, this was the design engineer’s option.) Removal of this lower density material likely improved the resistance of joints to water intrusion and freeze-thaw damage. However, it is unlikely that it substantially improved the joint’s resistance to cracking due to horizontal strains

resulting from daily and seasonal expansion and contraction of the pavement. Of the state highway and aviation specifications evaluated in this project, Wisconsin was the only one requiring joint density testing.

Transverse (thermal) cracking is controlled by the binder grade and aggregate type. Aging susceptibility of the binder also plays a role. Aging rate may also be affected by interconnected air voids, which can be related to in-place density. Improving the resistance to thermal cracking may be accomplished by specifying the appropriate low-temperature binder grade for the climate and by being more restrictive on certain aggregate types in cold climates. Alternatively, requiring a validated thermal cracking test, such as ASTM D7313-20, the disc-shaped compact tension test, as part of a BMD procedure would likely improve the resistance of airfield pavements to thermal cracking.

Environmental-related cracking was the predominant mode of distress on the airports evaluated in this study. However, a small percentage of projects also had load-related damage. Of the eight projects with load-related distresses, one had medium-severity alligator cracking (an 18-year-old taxiway), five had low-severity alligator cracking, and two had low-severity rutting. It should be noted that only two projects had rutting distresses, and both used FAA specifications. Of the six projects that experienced alligator cracking, five of them used state specifications. This could indicate that asphalt mixtures designed and produced under some state specifications could be more susceptible to fatigue cracking. Those relatively few projects with load-related distress were scattered among four states: Illinois, Indiana, Michigan, and Wisconsin. However, fatigue cracking is also related to insufficient structural capacity of the pavement—either the pavement design is inadequate, the loading on the pavement has increased beyond the design conditions, or something has changed in the pavement structure that has reduced the load-carrying capacity of the pavement.

Table 11. Summary of Projects Based on Type of Distress Deduct

State	Airport	Runway	% Distress Deducts			Specifications
			Load	Climate	Other	
Georgia	Columbus (CSG)	06/24	0	95	5	FAA
Georgia	Albany - Southwest Georgia Regional (ABY)	04/22	-	-	-	FAA
Georgia	Athens-Ben Epps Airport (AHN)	09/27	-	-	-	FAA
Georgia	Winder-Barrow County Airport (WDR)	05/23	0	100	0	FAA
Georgia	Winder-Barrow County Airport (WDR)	13/31	0	100	0	FAA
Indiana	Anderson Municipal Airport (AID)	Taxiway A	0	100	0	FAA
Indiana	Anderson Municipal Airport (AID)	Taxiway A	0	100	0	FAA
Indiana	Anderson Municipal Airport (AID)	Taxiway A	15	85	0	FAA
Indiana	Columbus Municipal (BAK)	Taxiway D	0	100	0	FAA
Indiana	Logansport - Cass County (GGP)	09/27	14	85	1	FAA
Indiana	Peru Municipal (I76)	01/19	0	100	0	FAA
Michigan	St. Clair County International Airport (PHN)	10/28	0	100	0	FAA
Wisconsin	Amery Municipal Airport (AHH)	18/36	0	100	0	FAA
Wisconsin	Baraboo-Wisconsin Dells Regional (DLL)	Apron	0	100	0	FAA
Wisconsin	Bloyer Field (Y72)	Apron	0	100	0	FAA
Wisconsin	Bloyer Field (Y72)	Taxiway A	0	100	0	FAA
Wisconsin	Cumberland Municipal Airport (UBE)	Apron	21	79	0	FAA
Wisconsin	Cumberland Municipal Airport (UBE)	09/27	0	100	0	FAA
Wisconsin	Cumberland Municipal Airport (UBE)	Taxiway A	0	100	0	FAA
Wisconsin	East Troy Municipal Airport (57C)	08/26	0	100	0	FAA
Wisconsin	Fond Du Lac County Airport (FLD)	Apron	0	96	4	FAA
Wisconsin	Park Falls Municipal Airport (PKF)	18/36	0	100	0	FAA
Georgia	Columbus (CSG)	13/31	0	100	0	State
Georgia	Rome-Richard B. Russell Regional Airport	07/25	-	-	-	State
Georgia	Dahlonega-Wimpy's Lumpkin County Airport (9A0)	15/33	0	100	0	State
Illinois	Waukegan National Airport (UGN)	14/32	0	87	13	State
Illinois	Edgar County Airport (PRG)	18/36	0	100	0	State

State	Airport	Runway	% Distress Deducts			Specifications
			Load	Climate	Other	
Illinois	Bolingbrook's Clow International Airport (1C5)	18/36	0	100	0	State
Illinois	DuPage Airport (DPA)	10/28	22	78	0	State
Illinois	Chicago Executive Airport (PWK)	16/34	0	100	0	State
Michigan	Cheboygan County Airport (SLH)	17/35	17	49	34	State
Michigan	Houghton County Memorial Airport (CMX)	07/25	0	100	0	State
Michigan	Kirsch Municipal Airport (IRS)	06/24	0	100	0	State
Michigan	Marlette Township Airport (77G)	01/19	0	100	0	State
Michigan	Oakland County International Airport (PTK)	18/36	0	100	0	State
Wisconsin	Prairie du Chien (PDC)	11/29	14	86	0	State
Wisconsin	Fort Atkinson (61C)	03/21	11	89	0	State
Wisconsin	Crandon (YSS)	11/29	0	100	0	State
Wisconsin	Clintonville (CLI)	04/22	0	100	0	State
Wisconsin	Oconto (OCQ)	11/29	0	100	0	State
Wisconsin	East Troy Municipal Airport (57C)	Taxiway B	33	67	0	State

8. CONCLUSIONS AND RECOMMENDATIONS

The Federal Aviation Administration (FAA) Reauthorization Act of 2018, Section 136 requires the FAA to allow the use of state highway specifications for airfield pavement construction at non-primary airports serving aircraft that do not exceed 60,000 lb. This can occur if it is requested by the state, safety will not be negatively impacted, and the life of the pavement will not be shorter than if constructed using FAA specifications. Although this is relatively new legislation, the FAA has permitted the use of state highway specifications for the construction of airports under certain conditions since 2000. There are significant differences in loads, tire pressures, and types of loading between highways and airports, and highway specifications were not developed considering those differences. Therefore, the FAA initiated this project to evaluate the performance of airport pavements constructed using highway specifications and to compare that performance to that of airport pavements constructed using FAA specifications. Consequently, the purpose of this study was to provide the FAA with data to determine if state highway materials and construction requirements can perform satisfactorily at non-primary, public-use airports serving aircraft less than 60,000 lb gross weight.

This evaluation gathered pavement performance data and construction information (when available) from 40 projects in five states (Georgia, Illinois, Indiana, Michigan, and Wisconsin). Of those 40 projects, 19 used state specifications, whereas 21 used traditional FAA specifications. Based on the information compiled and analyzed during this project, the following conclusions have been drawn:

1. Based on pavement condition index (PCI) ratings, the performance of airport asphalt pavements constructed using state highway and aviation specifications is statistically equivalent to pavements constructed using FAA specifications. Performance trends indicate a PCI rating of approximately 60 at year 14 for both types of specifications.
2. Climate-based distresses were the predominant mode of distress for both FAA and state projects, with longitudinal and transverse cracking and weathering being the most prevalent type of distresses.
3. The number of load-related distresses was relatively low. Only 8 of the 40 projects evaluated had load-related distresses. Of those projects, five used state specifications and three used FAA specifications.
4. Of the six projects with alligator (fatigue) cracking, five used state specifications, which could be an indicator that the state specification mixes may have reduced fatigue resistance. This observation should be further validated with additional field work and, if confirmed, additional laboratory experimental work and modeling would be warranted.
5. Only two projects experienced rutting distresses, and both used FAA specifications. The lack of rutting on state specification projects may indicate that the use of state specifications does not seem to increase the risk of rutting. However, more results with similar loading and environmental conditions from both FAA and state highway projects are needed to provide a generalized conclusion.

6. The FAA specification requirements for asphalt mix design generally should result in slightly higher effective asphalt contents than state highway mix design requirements. This could be a factor in the small differences in load-related distresses observed on a few of the airfields. However, construction records were unavailable for further analysis.
7. Although the mat density requirements for state specifications are similar to those in the FAA specification, the FAA has a strict method specification for joint construction plus a joint density requirement. However, most of the state specifications examined did not include a joint density requirement. Although it was expected that the FAA joint specification would reduce distresses associated with longitudinal joints, the available data do not presently support that conclusion. Given the predominance of longitudinal cracking distresses on airports, additional studies of this issue are warranted.
8. Several of the state specifications used on airport projects in this study were not true highway specifications. Of the five states evaluated, three had separate aviation specifications that were used for airport construction.
9. The overall scope of this project was somewhat limited to information from projects in five states.

Based on the above conclusions, the following recommendations are made:

1. From the analysis of pavement performance of airfield pavements constructed with FAA specifications and state specifications, no differences in pavement life were evident. This finding supports the use of state highway specifications for airfield asphalt pavements at non-primary airports serving aircraft that do not exceed 60,000 lb, if requested by the state.
2. Additional guidance should be provided for airports using state specifications regarding the construction and acceptance of longitudinal joints.
3. Given the predominance of climate-related distresses on asphalt airfield pavements, further research is warranted. Such research should involve the selection of suitable mixture cracking and durability performance tests related to environmental distresses, and establishment of criteria for the future use of the test (or tests) in FAA mix design and acceptance specifications.

9. REFERENCES

Airport Data and Information Portal (ADIP). Retrieved July 2021 from <https://adip.faa.gov/agis/public/#/public>

American Association of State Highway and Transportation Officials. (1993). AASHTO Guide for Design of Pavement Structures, 1993. Washington, D.C.

American Association of State Highway and Transportation Officials. (2011). Standard Specification for Performance-Graded Asphalt Binder AASHTO M 320. Washington, D.C.

- American Association of State Highway and Transportation Officials. (2012). Standard Specification for Performance-Graded Asphalt Binder Using Multiple Stress Creep Recovery (MSCR) Test AASHTO M 332. Washington, D.C.
- Asphalt Institute. (1983). *Asphalt technology and construction practices*. (pp. J5–J7).
- ASTM International. (2018). *Standard test method for airport pavement condition index surveys*. (ASTM D5340-12).
- ASTM International. (2006). *Standard Test Method for Elastic Recovery of Bituminous Materials by Ductilometer*. (ASTM D6084-06).
- ASTM International. (2012). *Standard Test Method for Preparation and Determination of the Relative Density of Asphalt Mix Specimens by Means of the Superpave Gyrotory Compactor*. (ASTM D6925-12).
- ASTM International. (2012). *Standard Practice for Preparation of Asphalt Mixture Specimens Using Marshall Apparatus*. (ASTM D6926-12).
- ASTM International. (2016). *Standard Specification for Minimum Requirements for Agencies Testing and Inspecting Road and Paving Materials*. (ASTM D3666-16).
- ASTM International. (2020). *Standard Test Method for Determining Fracture Energy of Asphalt Mixtures Using the Disk-Shaped Compact Tension Geometry*. (ASTM D7313-20).
- Asphalt Institute. (2015). MS-2 Asphalt Mix Design Methods, ISBN: 9781934154700
- Attoh-Okine, N., and O. Adarkwa. (2013). *Pavement condition surveys—overview of current practices*. Delaware Center for Transportation, University of Delaware. <https://cpb-us-w2.wpmucdn.com/sites.udel.edu/dist/1/1139/files/2013/10/Rpt-245-Pavement-Condition-Okine-DCTR422232-1pzk0uz.pdf>
- Bennert, T., Sheehy, E., Blight, R., Gresavage, S. & Fee, F.. *Implementation of performance-based specifications for asphalt mix design and production quality control for New Jersey*. (Transportation Research Circular E-C189). TRB.
- Brown, E. R., Kandhal, P. S., Roberts, F. L., Kim, Y. R., Lee, D., & Kennedy T. (2009). *Hot mix asphalt materials, mixture design, and construction*. Lanham, MD: NAPA Education Foundation.
- Buncher, M. & Boyer, B., (2009). *Guideline for use of highway specifications for HMA airport pavements*. Airfield Asphalt Pavement Technology Program, Final Report Project 06-05. <https://eng.auburn.edu/research/centers/ncat/files/aaptp/Report.Final.06-05.pdf>
- Chen W. F. & Liew J. Y. R. (Eds.) (2003). *The Civil Engineering Handbook, Second Edition*. CRC Press, LLC. P233–245.

- Cooper III, S., Mohammad, L., Kabir, S., & King, W. (2014). Balanced asphalt mixture design through specification modification - Louisiana's experience. *Transportation Research Record: Journal of the Transportation Research Board*. 2447, 92–100.
- Federal Aviation Administration. (1977, December 6). Advisory Circular (AC) 150/5100-13, *Development of state standards for general aviation airports*. https://www.faa.gov/documentLibrary/media/Advisory_Circular/150-5100-13C.pdf
- Federal Aviation Administration. (2014, September 10). Advisory Circular (AC) 150/5320-17A, *Airfield Pavement Surface Evaluation and Rating Manuals*. https://www.faa.gov/airports/resources/advisory_circulars/index.cfm/go/document.current/documentNumber/150_5320-17
- Federal Aviation Administration. (2014, July 21). Advisory Circular (AC) 150/5370-10H, *Standards for Specifying Construction of Airports*. https://www.faa.gov/documentLibrary/media/Advisory_Circular/150-5370-10H.pdf
- Federal Aviation Administration. (2009, September 30) Advisory Circular (AC) 150/5320-6E, *Airport Pavement Design and Evaluation*. https://www.faa.gov/documentLibrary/media/advisory_circular/150_5320_6e.pdf
- Federal Aviation Administration. (2016, November 10). Advisory Circular (AC) 150/5320-6F, *Airport Pavement Design and Evaluation*. https://www.faa.gov/documentLibrary/media/advisory_circular/150-5320-6f.pdf
- Federal Aviation Administration. National Plan of Integrated Airport Systems (2011–2015). https://www.faa.gov/airports/planning_capacity/npias/current/
- Florida Department of Transportation. (2018, July 1). Standard Specifications for Road and Bridge Construction. <https://www.fdot.gov/programmanagement/implemented/pecbooks/default.shtm>
- Garg, N., Guo, E., & McQueen, R. (2004). *Operational life of airport pavements*. (Report No. DOT/FAA/AR-04/46).
- Georgia Department of Transportation Standard Specifications Construction of Transportation System (2013), 2013 Edition.
- Gillespie, W. M. (2005). *A Manual of the Principles and Practice of Roadmaking: Comprising the Location, Construction, and Improvement of Roads, and Railroads, 3rd ed.* A.S. Barnes & Co.
- Gulfstream G450 Maintenance Manual (2013).
- Illinois Department of Transportation. (2012). *Illinois standard specifications for construction of airports*. [https://idot.illinois.gov/assets/uploads/files/doing-business/manuals-guides-&-handbooks/aero/new%20spec%20book%20\(effective%204-1-2012\).pdf](https://idot.illinois.gov/assets/uploads/files/doing-business/manuals-guides-&-handbooks/aero/new%20spec%20book%20(effective%204-1-2012).pdf)

- Jamieson, S. & White, G. (2019). *Developing a performance-based specification for stone mastic asphalt as an ungrooved runway surface*, Paper presented at 2019 International Airfield and Highway Pavements Conference.
- Miller, J. S., Simpson, A. L., & Dragos, A. (2009). *Performance-Based Specifications for HMA Pavements on Airfields*. AAPT Project 06-03. <https://www.eng.auburn.edu/research/centers/ncat/files/aapt/Report.Final.06-03.pdf>
- Mitchell, T. (1996, September 10) *Westrack: The Road to Solutions*. Public Roads Magazine, Volume 60(2). <https://www.eng.auburn.edu/research/centers/ncat/files/aapt/Report.Final.06-03.pdf>
- National Cooperative Highway Research Program (NCHRP). (1976). *NCHRP Synthesis 38: Statistically Oriented End-Result Specifications*.
- National Cooperative Highway Research Program (NCHRP). (1995) *NCHRP Synthesis 212: Performance-related specifications for highway construction and rehabilitation*.
- National Cooperative Highway Research Program (NCHRP). (2002) *NCHRP Report 455: Recommended performance-related specification for hot-mix asphalt construction: Results of the Westrack Project*. https://onlinepubs.trb.org/onlinepubs/nchrp/nchrp_rpt_455a.pdf
- National Cooperative Highway Research Program (NCHRP). (2005). *NCHRP Synthesis 346: State Construction Quality Assurance Programs*. <https://nap.nationalacademies.org/read/23310/chapter/1>
- National Cooperative Highway Research Program (NCHRP). (2016). *Synthesis 492: Performance Specifications for Asphalt Mixtures*. <https://nap.nationalacademies.org/read/23564/chapter/1#ii>
- New Jersey Department of Transportation. (2014). Standard Specifications for Road and Bridge Construction.
- Rushing, J. & Garg, N. (2017). Using the asphalt pavement analyzer as a mixture performance test to select appropriate binder grades for airport pavements. *Journal of Transportation Engineering, Part B: Pavements*, 143(3). <https://doi.org/10.1061/JPEODX.0000012>
- Timm, D. H., and J. M. McQueen. *A Study of Manual vs. Automated Pavement Condition Surveys*. Highway Research Center, Auburn University, Auburn, Ala., 2004.
- Transportation Research Board. (2018). *Glossary of transportation construction quality assurance terms*. (Transportation Research Circular E-C235). <https://onlinepubs.trb.org/onlinepubs/circulars/ec235.pdf>
- Unified Facilities Guide Specifications. (2020 November 1). UFGS 32 12 15.13, *Asphalt paving for airfields*. <https://www.wbdg.org/ffc/dod/unified-facilities-guide-specifications-ufgs/ufgs-32-12-15-13>

- Walker, D., Entine, L. & Kummer, S. (2014). *Pavement Surface Evaluation and Rating Manual—Asphalt Airfield Pavements*. University of Wisconsin-Madison.
- West, R., Rodezno, C., Leiva, F., & Yin, F. *Development of a Framework for Balanced Mix Design*. Project NCHRP 20-07/Task 406 Final Report, 2018.
- White, G. *Developing a Performance Specification for Airport Asphalt*. 2017.
- Zhou, F., Scullion, T., Walubita, L. & Wilson, B. (2014). *Implementation of a Performance-Based Mix Design System in Texas*. (Transportation Research Circular E-C189). TRB.

APPENDIX A—AIRPORT REPORTS

A brief summary was compiled of information collected from each airport included in this study. The basic information collected included:

- Airport Owner and Manager
- Basic information on the airport (location, runway information, runway classification, airport map, etc.)
- Construction information—as available (description of specifications, summary of construction activities, pavement typical sections, quality control and acceptance summaries, etc.)
- Performance information

Georgia

Columbus Airport

Owner: Columbus Airport Commission
3250 W Britt David Road
Columbus, GA 31909
Phone 706-324-2449

Manager: Amber Clark, C.M.
3250 W Britt David Road
Columbus, GA 31909
Phone 706-324-2449

Columbus Airport (CSG) is 4 miles northeast of Columbus in Muscogee County, Georgia. The National Plan of Integrated Airport Systems (NPIAS) for 2021–2025 categorized it as a primary commercial service airport (more than 10,000 enplanements per year). The airport covers 680 acres (275 ha) at an elevation of 397 ft (121 m). It has two asphalt runways: 6/24 is 6,997 ft x 150 ft and 13/31 is 3,997 ft x 150 ft (see Figure A-1).

Runway 6/24

- Pavement Classification Number (PCN) 91 /F/B/W/T
- Rehabilitation and Overlay of Runway 6/24 (Federal Specifications) completed June 2011
- FAA Airport Improvement Program (AIP) Project No. 3-13-0035-031-2008

Runway 13/31

- PCN 12 /F/B/W/T

- Rehabilitation of Runway 13/31 (State Specifications) completed February 2016

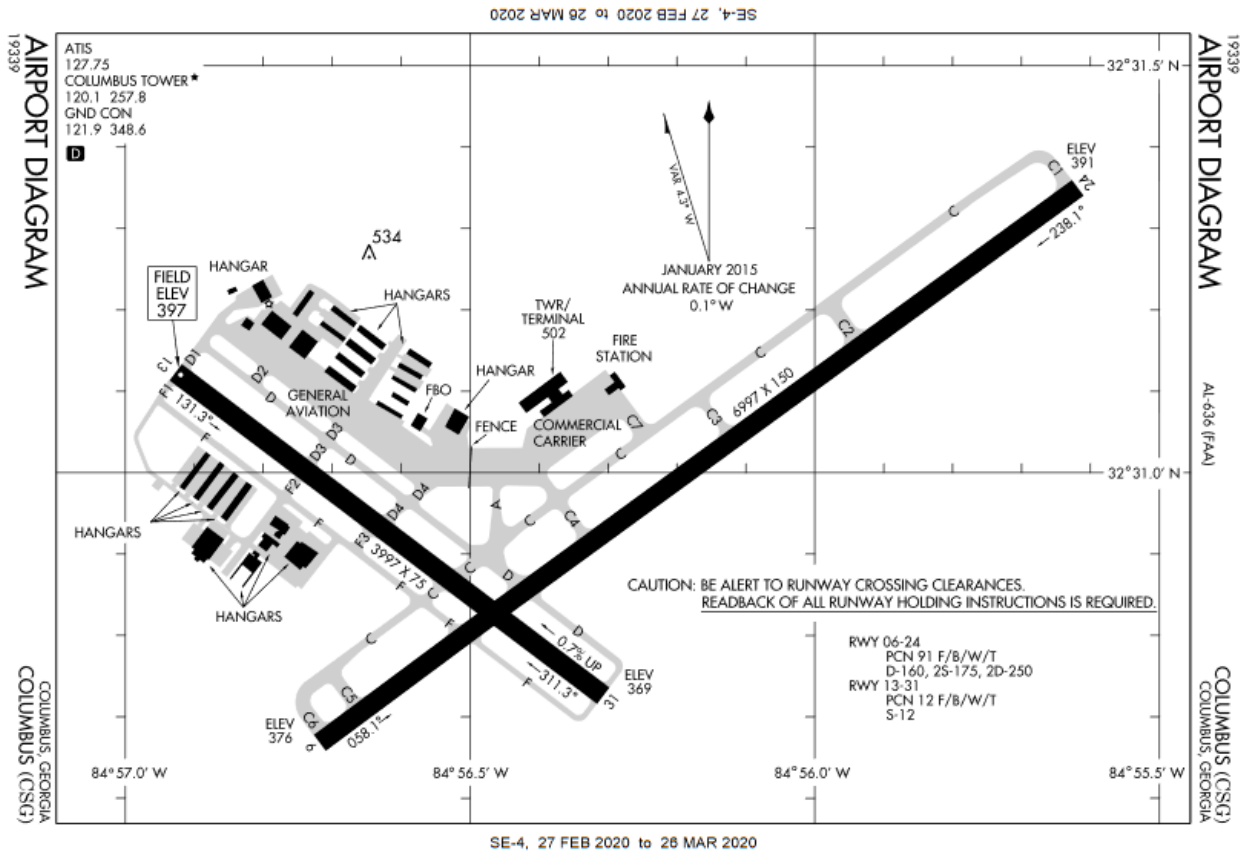

Figure A-1. Columbus Airport Diagram (source www.aopa.org)

Specifications and Plans

Runway 6/24

The airport manager provided a set of construction plans, which included geotechnical information and exploration sites, demolition plans, typical sections, runway profiles, and other information. The plans included a 2-in. mill and fill rehabilitation strategy with a cross slope that varies throughout the entire runway. The typical section for the main portion of Runway 6/24 can be found in Figure A-2.

The consultant for the rehabilitation design was The LPA Group Incorporated, Transportation Consultants, Atlanta, Georgia.

The following specifications were extracted from the provided set of specifications:

- ITEM S-180 PAVEMENT MILLING provides equipment and operation requirements.
- ITEM P-400 CONSTRUCTION OPERATIONS provides general requirements for the construction operations of this project.

- ITEM P-401 PLANT MIX BITUMINOUS PAVEMENTS provides requirements for materials, mixture design, testing, construction methods, materials acceptance, quality control (QC), and basis of payment.
- ITEM P-603 BITUMINOUS TACK COAT, requirements for materials, application, measurement, and payment.

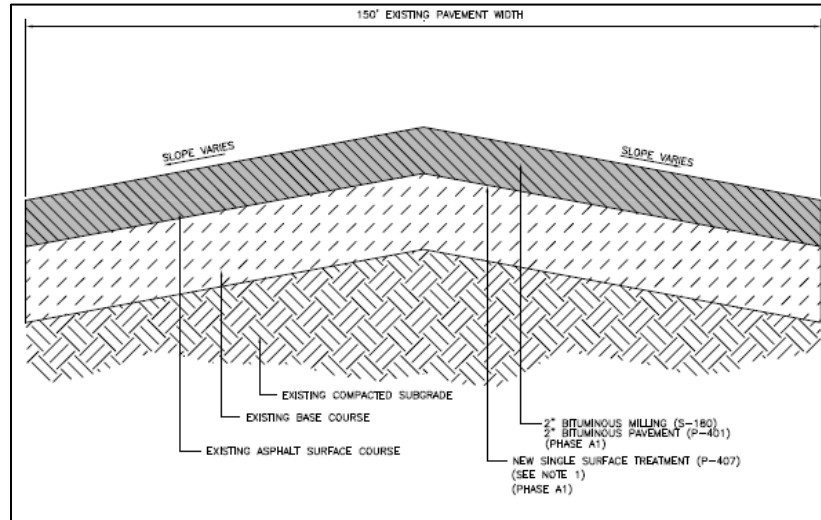

Figure A-2. Runway 6/24 Typical Section

Runway 13/31

The airport manager provided a set of construction plans. Rehabilitation of Runway 13/31 included bituminous pavement removal, earthwork, and turf installation to reduce the runway width from 150 ft to 75 ft, milling of existing pavement, bituminous paving of the remaining 75-ft-wide runway, pavement marking, and airfield electrical demolition.

Overall, the plans included a minimum 2-in. overlay rehabilitation strategy with a cross slope that varies throughout the entire runway. Mill and fill were required in some areas to comply with the designed profile. Full-depth reclamation (FDR) was the initial recommendation for rehabilitation.

The typical section for the main portion of Runway 13/31 can be found in Figure A-3.

Consultants' information: RS&H, Jacksonville, Florida. Willmer Engineering Inc, Atlanta, Georgia.

The following specifications were extracted from the set of specifications for this project:

- Section 400, Hot Mix Asphaltic Concrete Construction, provides requirements for materials, mixture design, testing, construction methods, materials acceptance, QC, and basis of payment

- Section 402, Hot Mix Recycled Asphaltic Concrete, includes producing and placing hot mix recycled asphaltic concrete that incorporates RAP, reclaimed asphalt shingles, virgin aggregate, hydrated lime, and neat asphalt cement
- Section 413, Bituminous Tack Coat, includes requirements for materials, application, measurement, and payment
- Section 802, Aggregates for Asphaltic Concrete, includes the requirements for fine and coarse aggregates used in asphaltic concrete

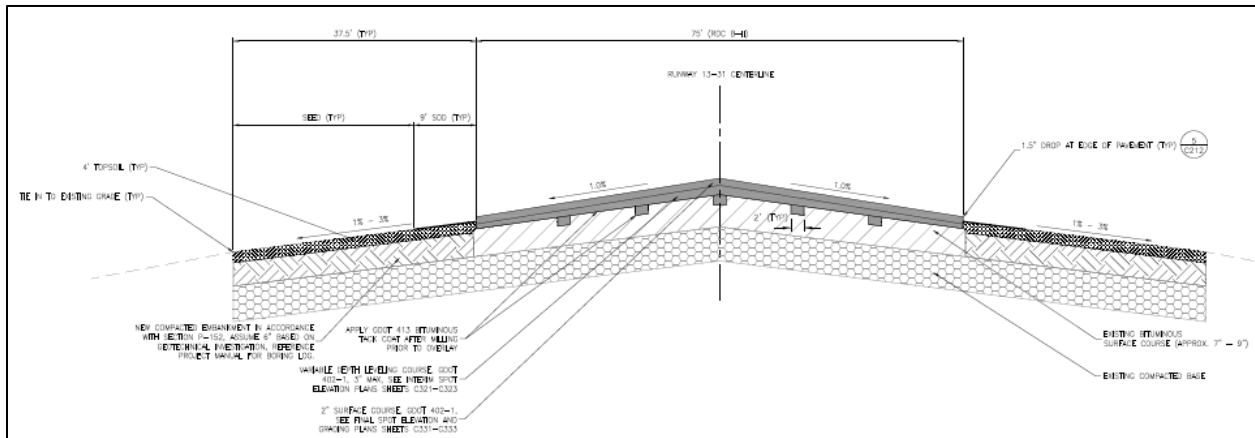

Figure A-3. Runway 13/31 Typical Section

Mix Design

No information on mix design submittals and acceptance criteria were provided.

Construction Report

The following contains a brief summary of the construction information located for this project.

Runway 6/24

Construction Consultant Information: Willmer Engineering Inc., Atlanta, Georgia.

Field reports indicated that paving operations were scheduled at night. No significant delays were reported (maximum 2 hours), and 1 day of paving was canceled because of rain.

Runway 13/31

Construction Consultant Information: Willmer Engineering Inc., Atlanta, Georgia.

Field reports indicated that paving operations were scheduled at night. No delays or cancellations were reported.

Control and Acceptance Results

Only acceptance results were provided for both airfields.

Runway 6/24

Sixteen lots were tested. Mixture properties for payment included laboratory air voids and field mat/joint density. Two lots failed to meet mat/joint density minimum criteria. Construction reports and notes from consultant indicated that laboratory test results passed the acceptance criteria for all 16 lots.

Runway 13/31

As indicated in the final field report, all tests resulted in 100% pay factors. All the provided reports contain field density test results and two laboratory test results of binder content. No other mixture properties were provided.

Pavement performance data

Runway 6/24

Based on the Pavement Management Reports provided by Applied Pavement Technology (APTech), the pavement condition index (PCI) measured in 2018 was on average 78.5 with several distresses. These included longitudinal and transverse cracking, swelling, and raveling. Airport personnel indicated during an interview in 2020 that no other distresses or issues had been observed to significantly impact pavement performance. A plot of the average PCI ratings since the project was completed is shown in Figure A-4.

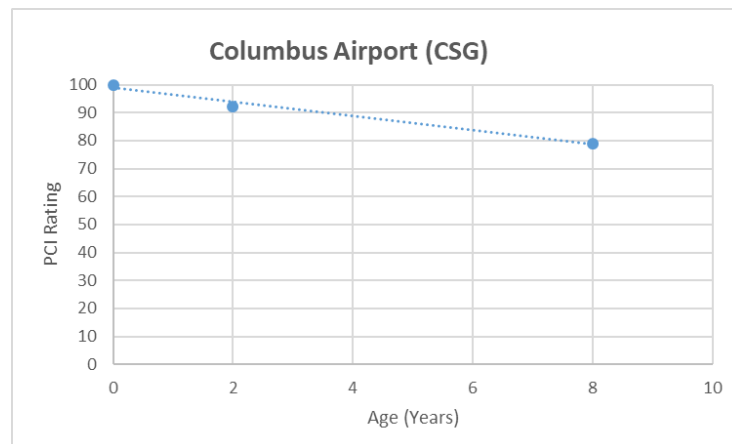

Figure A-4. Runway 6/24 PCI Rating

Runway 13/31

Based on the Pavement Management Reports provided by APTtech, the PCI measured in 2018 was on average 93.6 with longitudinal and transverse cracking as main distress. Airport personnel indicated, during an interview in 2020, that the longitudinal joints were partially open, and raveling on those joints had forced airport personnel to provide constant inspection and cleaning of the runway.

History of preventive or maintenance activities conducted on the airfield

Runway 6/24

Airport personnel indicated that no preventive or maintenance activities had been conducted on the airfield.

Runway 13/31

Airport personnel indicated that regular inspection and cleaning of the surface is performed (removal of loose aggregate particles) because of the deteriorating longitudinal joints.

Aircraft load and traffic data

Based on the Airport Data and Information Portal (ADIP), the overall airport traffic operation per year is as follows:

- Air carrier: 348
- Air taxi: 2,846
- General aviation local: 17,145
- General aviation itinerant: 15,885
- Military: 536
- TOTAL OPERATIONS: 36,760

Runway 6/24

A Traffic Flow Management System Count (TFMSC) Report was provided and contains aircraft descriptions and the number of arrivals/departures from January 2015 through November 2019.

Based on the ADIP, Runway 6/24 is subjected to the following loads:

- Dual wheel (D): 160,000 lb
- Two dual wheels in tandem (2D): 250,000 lb

Runway 13/31

Based on the ADIP, Runway 13/31 is subjected to the following load:

- Single wheel (S): 12,000 lb

Pavement Condition Evaluation

National Center for Asphalt Technology personnel visited this airport in 2020 and conducted a pavement condition evaluation on both runways. They followed ASTM D5340 (2018) *Standard Test Method for Airport Pavement Condition Index Surveys*. The PCI measured in 2020 for Runway 6/24 was 78.3 with several distresses, including longitudinal and transverse cracking, swelling, and raveling. Conversely, the PCI measured in 2020 for Runway 13/31 was 72.5 with several distresses, including longitudinal and transverse cracking, weathering, and raveling.

Albany Airport (ABY)

Owner: City of Albany, GA

Manager: David Hamilton

Address: 3905 Newton Road, Suite 100, Albany, GA 31701

Phone: 229-883-8330

Albany Airport is a non-hub, commercial service airport with approximately 15,000 annual operations. The NPAIS for 2011–2015 categorized it as a primary commercial service airport. It is located about 4 miles southwest of the city of Albany, Georgia. The airport covers 980 acres at an elevation of 196 ft. It has two asphalt runways: 04/22 is 6,601 ft x 148 ft and 16-34 is 5,219 ft x 148 ft (as shown in Figure A-5).

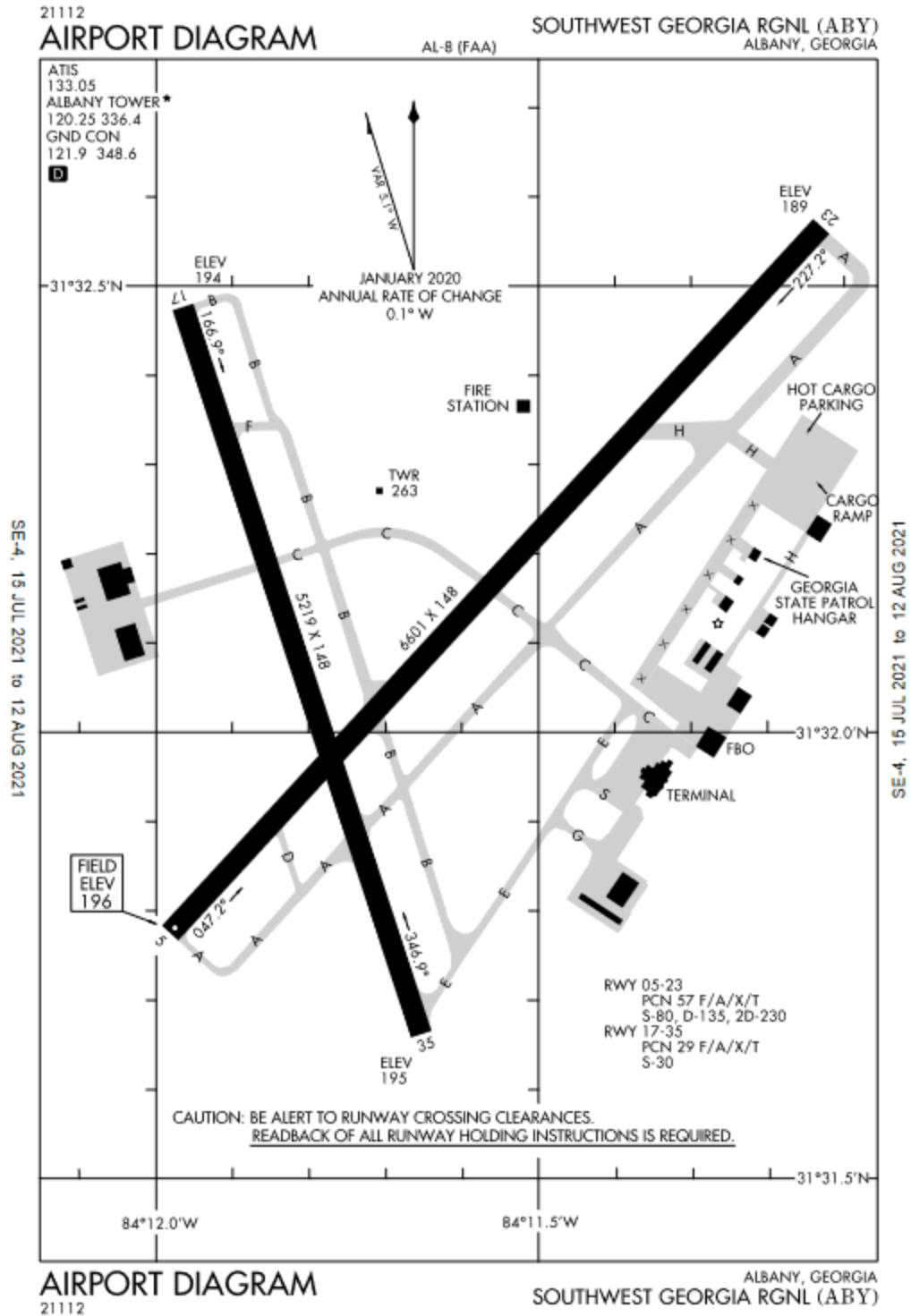

Figure A-5. Albany Airport Diagram (source www.aopa.org)

Runway 04/22

- PCN: 57 /F/A/X/T
- Dimensions: 6,601ft x 148 ft
- Rehabilitation and Overlay of Runway 04/22 (Federal Specifications) completed in 2019
- FAA AIP Project No. 3-13-0002-048-2018

Plans and Specifications

A set of construction plans was acquired. These plans included geotechnical information and exploration sites, demolition plans, typical sections, runway profiles, and other information. Overall, the plans included a 3-in. overlay over a double surface treatment strategy with a cross slope that varies throughout the entire runway. The typical section for the main portion of Runway 04/22 can be found in Figure A-6.

The consultant for the rehabilitation design was HOLT Consulting Company LLC, Duluth, Georgia.

The following specifications related to the construction of the asphalt concrete layer were extracted from the provided set of specifications:

- ITEM S-180 PAVEMENT MILLING provides equipment and operation requirements.
- ITEM P-401 PLANT MIX BITUMINOUS PAVEMENTS provides requirements for materials, mixture design, testing, construction methods, materials acceptance, QC, and basis of payment.
- ITEM P-602 BITUMINOUS PRIME COAT, provides requirements for materials, application, measurement, and payment.
- ITEM P-603 BITUMINOUS TACK COAT, requirements for materials, application, measurement, and payment.
- ITEM P-609 BITUMINOUS SURFACE TREATMENTS, provides requirements for materials, construction methods, measurement, and payment.

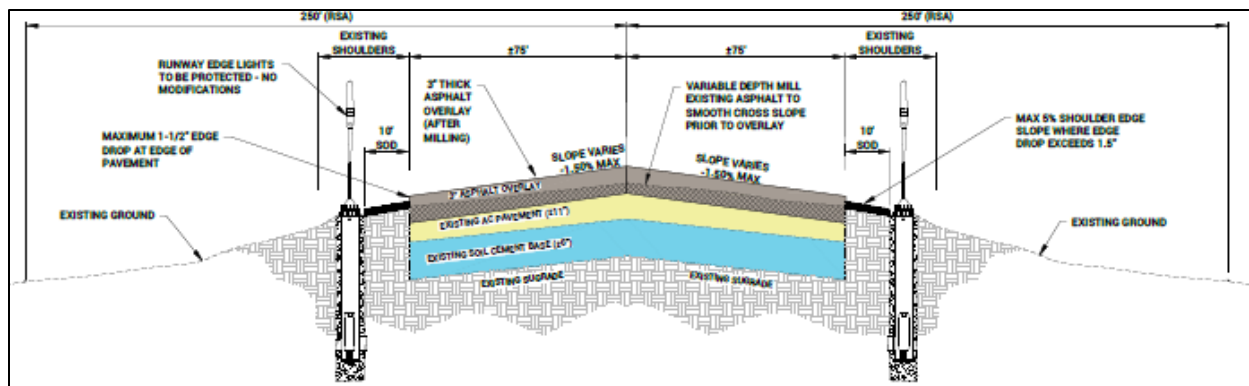

Figure A-6. Runway 04/22 Typical Section

Mix design

No information on mix design submittals and acceptance criteria was provided.

Construction Report

No information of contractor, schedule, notations, delays, etc., was obtained for this project.

Quality Control and Acceptance Results

No information related to laboratory and field results was obtained for this project.

Pavement performance data

Based on the Pavement Management Reports provided by APTEch, the PCI measured in 2019 was 100 with no distresses associated. Prior to this rehabilitation strategy, the reported PCI in 2012 was 61 with several distresses, including alligator cracking, longitudinal and transverse cracking, rutting, swelling, and weathering.

History of preventive or maintenance activities conducted on the airfield

No information related to any preventive or maintenance activities was reported since the project was finalized.

Aircraft load and traffic data

Based on the ADIP, the overall airport traffic operation per year is as follows:

- Air carrier: 1,516
- Air taxi: 1,892
- General aviation local: 1,634
- General aviation itinerant: 6,817
- Military: 2,510
- TOTAL OPERATIONS: 14,369

Based on the ADIP, Runway 04/22 is subjected to the following loads:

- Single wheel: 80,000 lb
- Dual wheel: 135,000 lb
- Two dual wheels in tandem: 230,000 lb

Athens–Ben Epps Airport

Owner: Clarke County, GA

Manager: Mike Matthews

Address: 1010 Ben Epps Drive, Athens, GA 30605

Phone: 706-613-3416

Athens–Ben Epps Airport (AHN) is a county-owned, public-use airport located 3.75 miles east of the central business district of Athens, a city in Clarke County, Georgia, United States. It is mostly used for general aviation, though it was formerly served by one commercial airline with scheduled passenger service subsidized by the Essential Air Service program. Athens–Ben Epps Airport covers an area of 425 acres at an elevation of 808 ft. It has two asphalt paved runways: 2/20 is 3,995 ft x 100 ft, and 09/27 is 6,122 ft x 100 ft. A diagram of the airport is shown in Figure A-7.

Runway 09/27

- PCN: 47 /F/B/X/T
- Dimensions: 6,122 ft x 100 ft
- Rehabilitation and Overlay of Runway 09/27 (FAA Specifications) completed in 2019
- GDOT Project No. AP018-9037-34(059) CLARKE

Plans and Specifications

A set of construction plans was acquired. These plans included geotechnical information and exploration sites, demolition plans, typical sections, runway profiles, and other information. Overall, the plans included a reconstruction of a 6-in. asphalt concrete layer with a cross slope that varies throughout the entire runway.

The consultant for the rehabilitation design was Holt Consulting Company LLC, Duluth, Georgia.

The following specifications related to the construction of the asphalt concrete layer were extracted from the provided set of specifications:

- ITEM S-180 PAVEMENT MILLING provides equipment and operation requirements.
- ITEM P-401 PLANT MIX BITUMINOUS PAVEMENTS provides requirements for materials, mixture design, testing, construction methods, materials acceptance, QC, and basis of payment.
- ITEM P-602 BITUMINOUS PRIME COAT provides requirements for materials, application, measurement, and payment.

- ITEM P-603 BITUMINOUS TACK COAT provides requirements for materials, application, measurement, and payment.
- ITEM P-609 BITUMINOUS SURFACE TREATMENTS provides requirements for materials, construction methods, measurement, and payment.

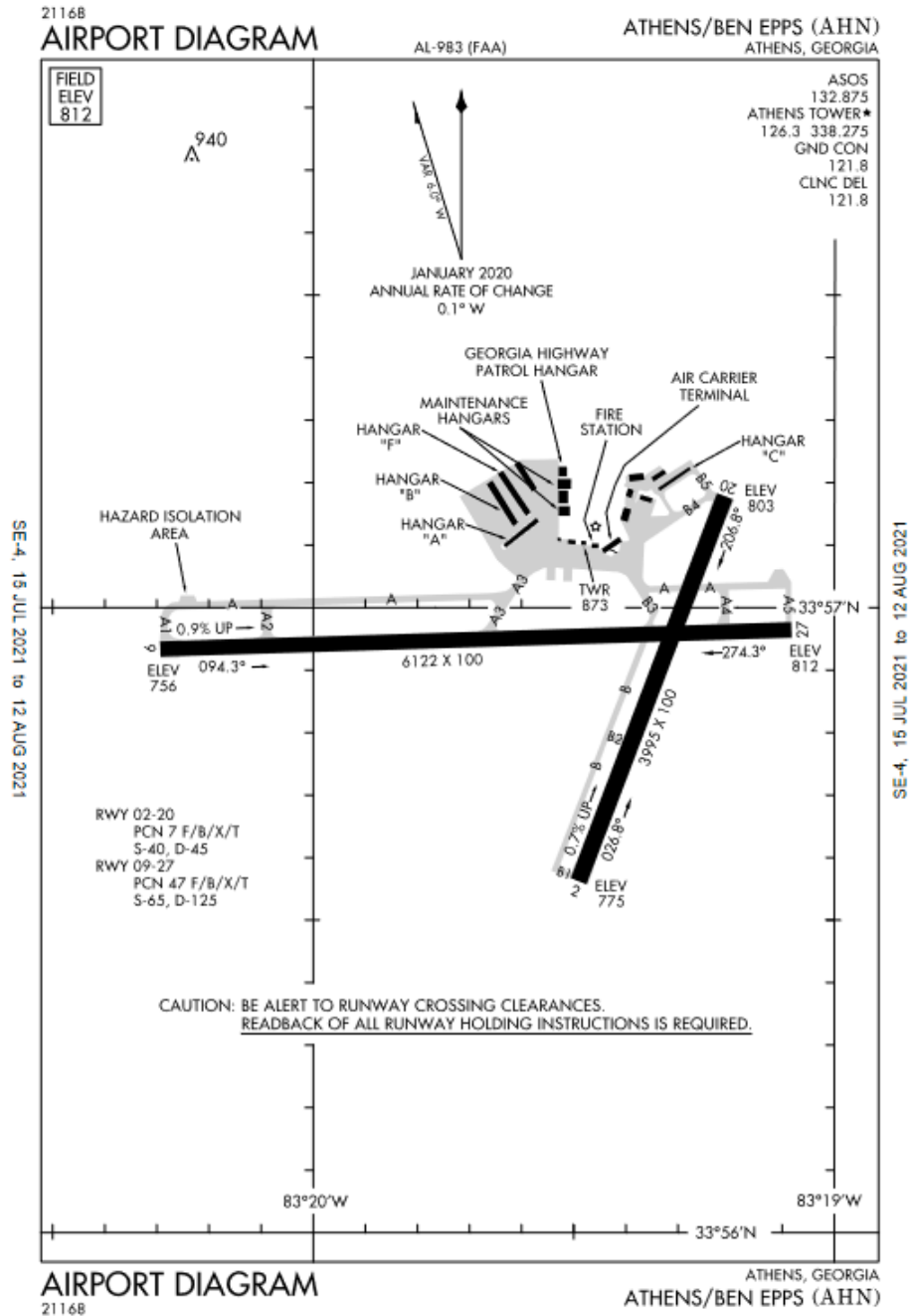

Figure A-7. Athens Airport Diagram (source www.aopa.org)

Mix design

No information on mix design submittals and acceptance criteria was provided.

Construction Report

The contractor for this project was C.W. Matthews Contracting Company. Holt Consulting Company, Engineer, and Aulick Engineering, Inspection, performed quality assurance with NOVA Engineering, Construction Material & Assurance Testing. The Notice to Proceed Date was July 9, 2018, and Runway 09/27 was opened January 29, 2019. No notations, information about delays, or other construction information were obtained for this project.

Quality Control and Acceptance Results

No information related to laboratory and field results was obtained for this project. However, the draft final Construction Report indicated that “All items passed testing in accordance with project specifications.”

Pavement performance data

Based on the Pavement Management Reports provided by APTECH, the PCI measured in 2019 was 100 with no distresses associated. Prior to this rehabilitation strategy, the reported PCI in 2012 was 70 with several distresses, including alligator cracking, and longitudinal and transverse cracking.

History of preventive or maintenance activities conducted on the airfield

No information related to any preventive or maintenance activities was reported since the project was finalized.

Aircraft load and traffic data

Based on the ADIP, the overall airport traffic operation per year is as follows:

- Air carrier: 51
- Air taxi: 1,315
- General aviation local: 15,544
- General aviation itinerant: 22,579
- Military: 771
- TOTAL OPERATIONS: 40,260

Based on the ADIP, Runway 09/27 is subjected to the following loads:

- Single wheel: 65,000 lb
- Dual wheel: 125,000 lb

Winder-Barrow Airport

Owner: Barrow County Airport Authority

Manager: Wanda Mitchell

Address: 841 Ronald Wood Road, Winder, GA 30680

Phone: 770-307-3013

Winder-Barrow Airport (WDR) is a public-use airport located 3.75 miles east of the central business district of Winder, a city in Barrow County, Georgia, United States. This airport is included in the National Plan of Integrated Airport Systems for 2011–2015, which categorized it as a general aviation facility. WDR covers an area of 374 acres at an elevation of 943 ft. It has two asphalt paved runways: 13/31 is 5,500 x 100 ft, and 5/23 is 3,610 ft x 100 ft (Figure A-8). Runway 13/31 has an instrument landing system.

Runway 5/23

- PCN NA
- Rehabilitation and Overlay of Runway 5/23 (Federal Specifications) completed in 2009

Runway 13/31

- PCN NA
- Rehabilitation of Runway 13/31 (Federal Specifications) completed in 2016

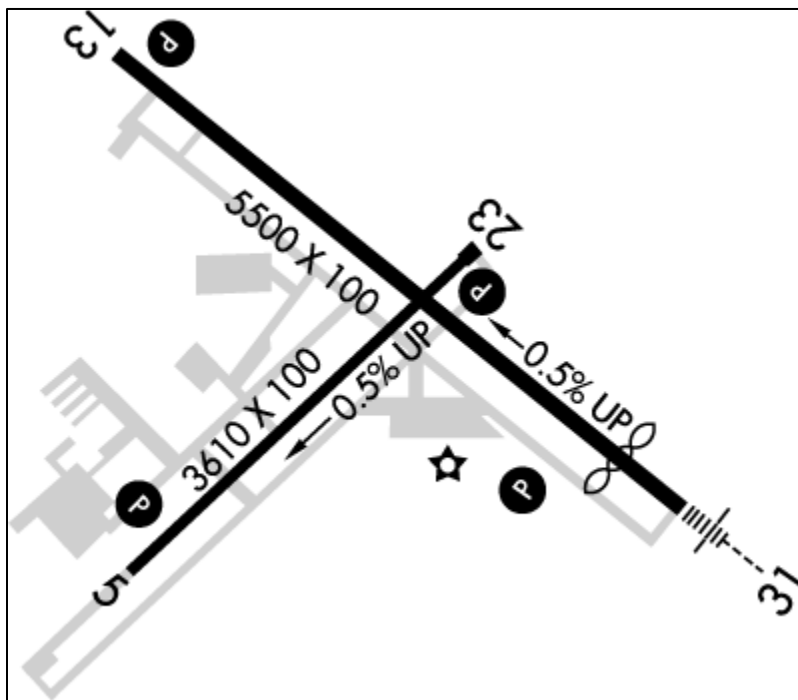

Figure A-8. Winder-Barrow Airport Diagram (source www.aopa.org)

Plans and Specifications

Runway 5/23

A set of construction plans was acquired, which included typical sections, runway profiles, and milling and pavement plans. Overall, the plans showed localized mill and fill sections within the runway as rehabilitation strategy. The consultant for the rehabilitation design was WK Dickson Community Infrastructure Consultants, located in Atlanta, Georgia.

Runway 13/31

A set of construction plans included milling of existing pavement, bituminous paving pavement, typical sections, runway profiles, and milling and pavement plans.

Overall, the plans included a minimum 1.5-in. mill and fill rehabilitation strategy with a cross slope that varies through the entire runway.

The following specifications were extracted from the set of specifications for this project:

- ITEM P-401 PLANT MIX BITUMINOUS PAVEMENTS provides requirements for materials, mixture design, testing, construction methods, materials acceptance, QC, and basis of payment.
- ITEM P-603 BITUMINOUS TACK COAT provides requirements for materials, application, measurement, and payment.

The consultant for the rehabilitation design was Lead Edge Design Group, located in Atlanta, Georgia.

Mix design

No information on mix design submittals and acceptance criteria was provided.

Construction Report

No construction report was acquired for these projects.

Quality Control and Acceptance Results

No information related to laboratory and field results was obtained for these projects.

Pavement performance data

Runway 6/24

Based on the Pavement Management Reports provided by APTEch, the PCI measured in 2012 (3 years after rehabilitation) was 85 with longitudinal and transverse cracking as main distress.

Runway 13/31

Based on the Pavement Management Reports provided by APTEch, the PCI measured in 2018 (2 years after rehabilitation) was 89 with several distresses, including longitudinal and transverse cracking, raveling, weathering.

History of preventive or maintenance activities conducted on the airfield

No information related to preventive or maintenance activities was obtained for these projects.

Aircraft load and traffic data

Based on the ADIP, the overall airport traffic operation per year is as follows:

- Air carrier: 0
- Air taxi: 0
- General aviation local: 20,000
- General aviation itinerant: 15,000
- Military: 5,000
- TOTAL OPERATIONS: 40,000

Based on the ADIP, both runways are subjected to the following load:

- Single wheel: 20,000 lb

Richard B. Russell Regional Airport

Owner: Floyd County, GA

Manager: John Carroll

Address: 304 Russell Field Road, Rome, GA 30161

Phone: 706-295-7835

Richard B. Russell Regional Airport (RMG) is a county-owned, public-use airport in Floyd County, Georgia. The airport is located 7.5 miles north of the central business district of Rome, Georgia. It is also known as Richard B. Russell Regional Airport. This airport is included in the FAA's National Plan of Integrated Airport Systems, which categorizes it as a general aviation facility. The airport covers an area of 985 acres at an elevation of 644 ft. It has two asphalt paved runways: 1/19 measures 6,006 ft x 143 ft, and 7/25 is 4,495 ft x 100 ft (Figure A-9).

Runway 7/25

- PCN: NA
- Dimensions: 4,495 ft x 100 ft
- Rehabilitation and Overlay of Runway 7/25 (State Specifications) completed in 2018.

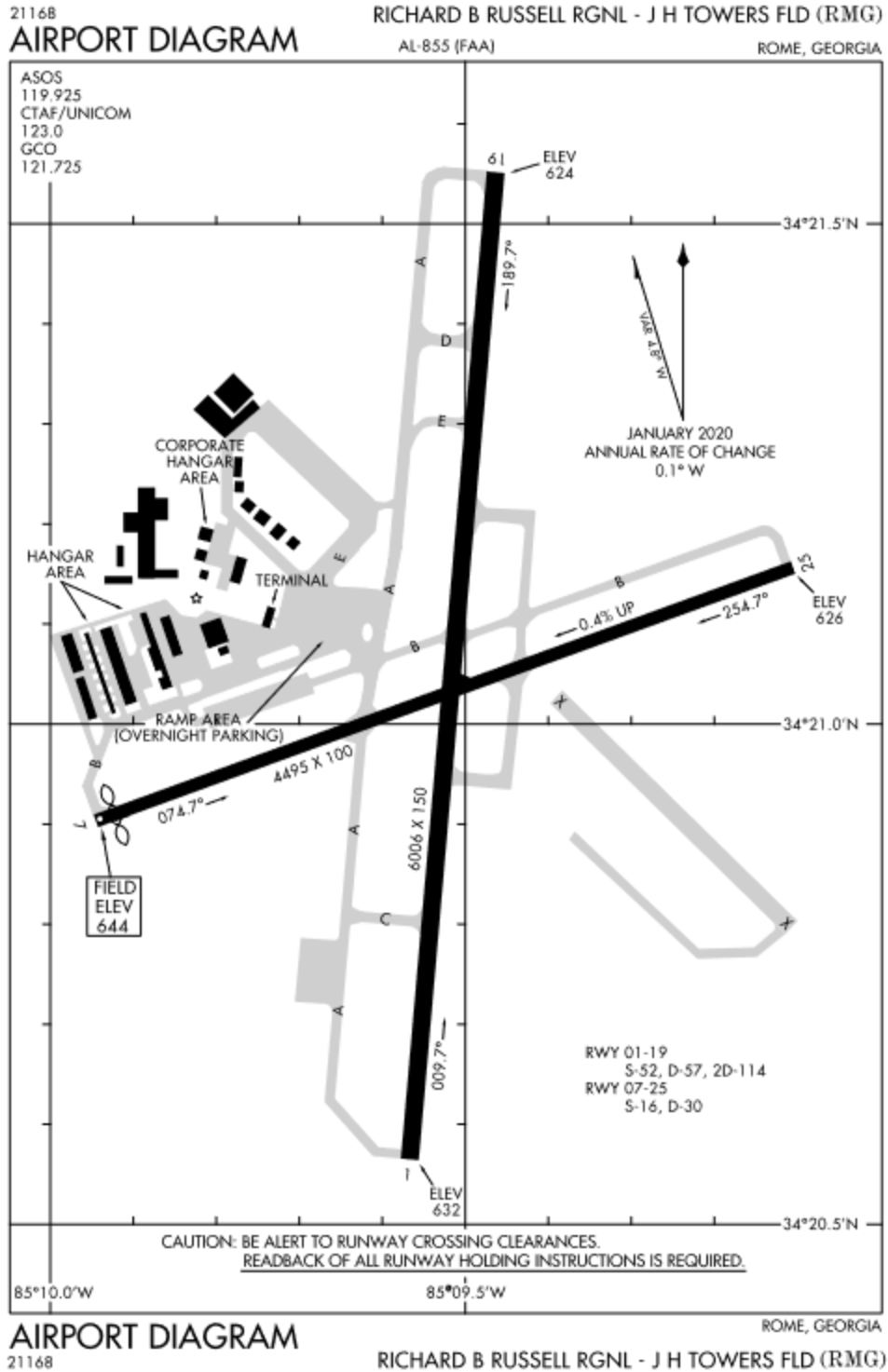

Figure A-9. Richard B. Russell Regional Airport Diagram (source www.aopa.org)

Plans and Specifications

A set of construction plans was acquired, which included geotechnical information and exploration sites, demolition plans, typical sections, runway profiles, and other information. Overall, the plans included a 2-in. overlay strategy with a cross slope that varies through the entire runway. The typical section for the main portion of Runway 7/25 can be found in Figure A-10.

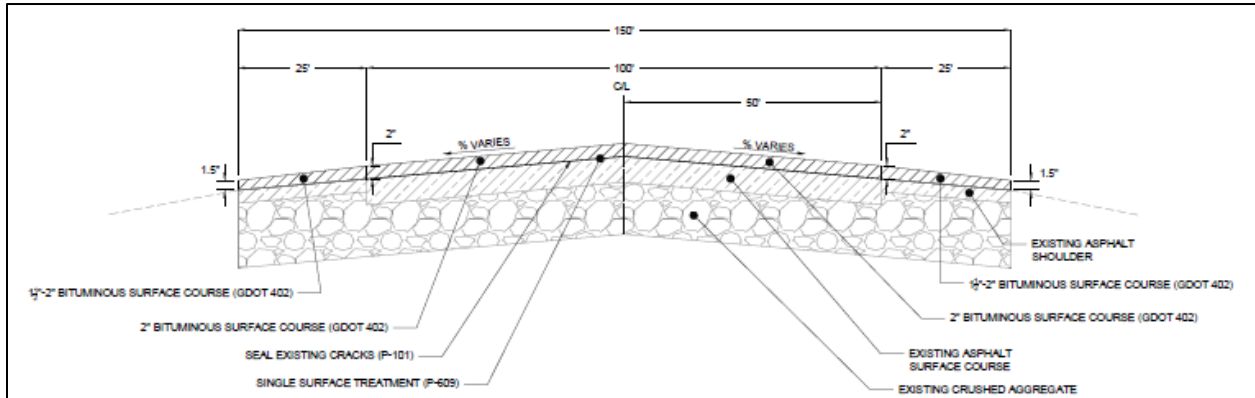

Figure A-10. Runway 7/25 Typical Section

The consultants for the rehabilitation design were Michael Baker International and NOVA Engineering and Environmental

Various federal, state, and local design standards were used in this project:

- ITEM P-101 SURFACE PREPARATION provides equipment and operation requirements.
- GDOT SECTION 402 HOT MIX RECYCLED ASPHALTIC CONCRETE provides requirements for materials, mixture design, testing, construction methods, materials acceptance, QC, and basis of payment.
- GDOT SECTION 413 BITUMINOUS TACK COAT provides requirements for materials, application, measurement, and payment.
- GDOT SECTION 432 MILL ASPHALTIC CONCRETE PAVEMENT provides equipment and operation requirements.
- GDOT SECTION 828 HOT MIX ASPHALTIC CONCRETE MIXTURES provides lower air voids for surface mixes on airport construction.
- FAA ADVISORY CIRCULARS (ACs) 150/5300-13A—*Airport Design*, and 150/5370-10G—*Standards for Specifying Construction of Airports*.

Mix design

No information on mix design submittals and acceptance criteria was provided.

Construction Report

No information on contractor, schedule, notations, delays, etc., was obtained for this project.

Quality Control and Acceptance Results

No information related to laboratory and field results was obtained for this project.

Pavement performance data

Based on the Pavement Management Reports provided by APTech, the PCI measured in 2018 was 100 with no distresses associated. Prior to this rehabilitation strategy, the reported PCI in 2012 was 54 with several distresses, including block cracking, raveling, and weathering.

History of preventive or maintenance activities conducted on the airfield

No information related to any preventive or maintenance activities was reported since the project was finalized.

Aircraft load and traffic data

Based on the ADIP, the overall airport traffic operation per year is as follows:

- Air carrier: 0
- Air taxi: 0
- General aviation local: 30,000
- General aviation itinerant: 30,000
- Military: 1,000
- TOTAL OPERATIONS: 61,000

Based on the ADIP, Runway 7/25 is subjected to the following loads:

- Single wheel: 16,000 lb
- Dual wheel: 30,000 lb

Lumpkin County-Wimpys Airport

Owner: Lumpkin County Airport Authority

Manager: Jimmy Berrong

Address: 682 Camp Wahsega Road, GA 30533

Phone: 706-265-0284

Lumpkin County Airport (9A0) is located 3 miles from the center of Dahlonega, Georgia. The airport covers an area of 64 acres at an elevation of 1328.8 ft. It has one runway, 15/33, as shown in Figure A-11.

Runway 15/33

- PCN: NA
- Dimensions: 3,024 ft x 50 ft
- Rehabilitation and Overlay of Runway 15/33 (State Specifications) completed in 2015
- Project No. AP016-9000-09(187)

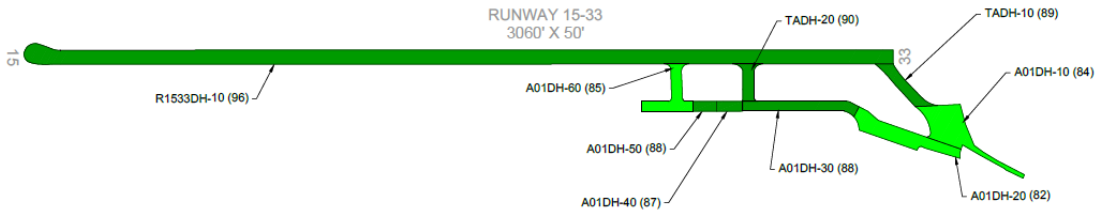

Figure A-11. Lumpkin County-Wimpys Airport Diagram (source APTech)

Plans and Specifications

A set of construction plans was acquired, which included typical sections, runway profiles, and material estimates. Overall, the plans do not specify the thickness of the new asphalt concrete layer or any other rehabilitation strategy. No specifications were available for this project.

Mix design

A document containing the submitted job mix formula indicates that the asphalt mixture was a 9.5 mm NMAAS containing 30% RAP with a performance grade (PG) 64-22 asphalt binder. This JMF was submitted by C.W. Matthews Contracting, Inc.

Construction Report

No information of contractor, schedule, notations, delays, etc. was obtained for this project.

Quality Control and Acceptance Results

No information related to laboratory and field results was obtained for this project.

Pavement performance data

Based on the Pavement Management Reports provided by APTech, the PCI measured in 2019 was 96 with longitudinal and transverse cracking as main distress. Prior to this rehabilitation strategy, the reported PCI in 2012 was 79 with longitudinal and transverse cracking, also as main distress.

History of preventive or maintenance activities conducted on the airfield

No information related to any preventive or maintenance activities was reported since the project was finalized.

Aircraft load and traffic data

Based on the ADIP, the overall airport traffic operation per year is as follows:

- Air carrier: 0
- Air taxi: 0
- General aviation local: 3,000
- General aviation itinerant: 2,000
- Military: 600
- TOTAL OPERATIONS: 5,600

Based on the ADIP, Runway 15/33 is subjected to the following loads:

- Single wheel: 12,000 lb

Illinois

Waukegan National Airport

Owner: Waukegan Port District

Manager: Skip Goss

Address: 2601 Plane Rest Drive, Waukegan, IL 60087

Phone: 847-244-0055

Description of the Airport

Waukegan National Airport (UGN) is located 35 miles north of Chicago. Waukegan National Airport is a general aviation facility categorized by the FAA as a Reliever Airport for Chicago's O'Hare International. Located in Lake County, Illinois, the Waukegan National Airport has 188 based aircraft and approximately 50,500 annual aircraft operations. The airport covers 600 acres (243 ha) at an elevation of 728 ft (220 m). The airport has two runways: 05/23, which is 6,001 ft x 150 ft, and 14/32, which is 3,750 ft x 75 ft (Figure A-12). Runway 14/32 is the focus of this report.

Runway 14/32

- PCN: NA
- Repair and Overlay of Runway 14/32 (Illinois Division of Aeronautics Specifications)
- AIP Project No. 3-17-0105-B44 and IDA Project No. UGN-3908
- Project completed September 2010

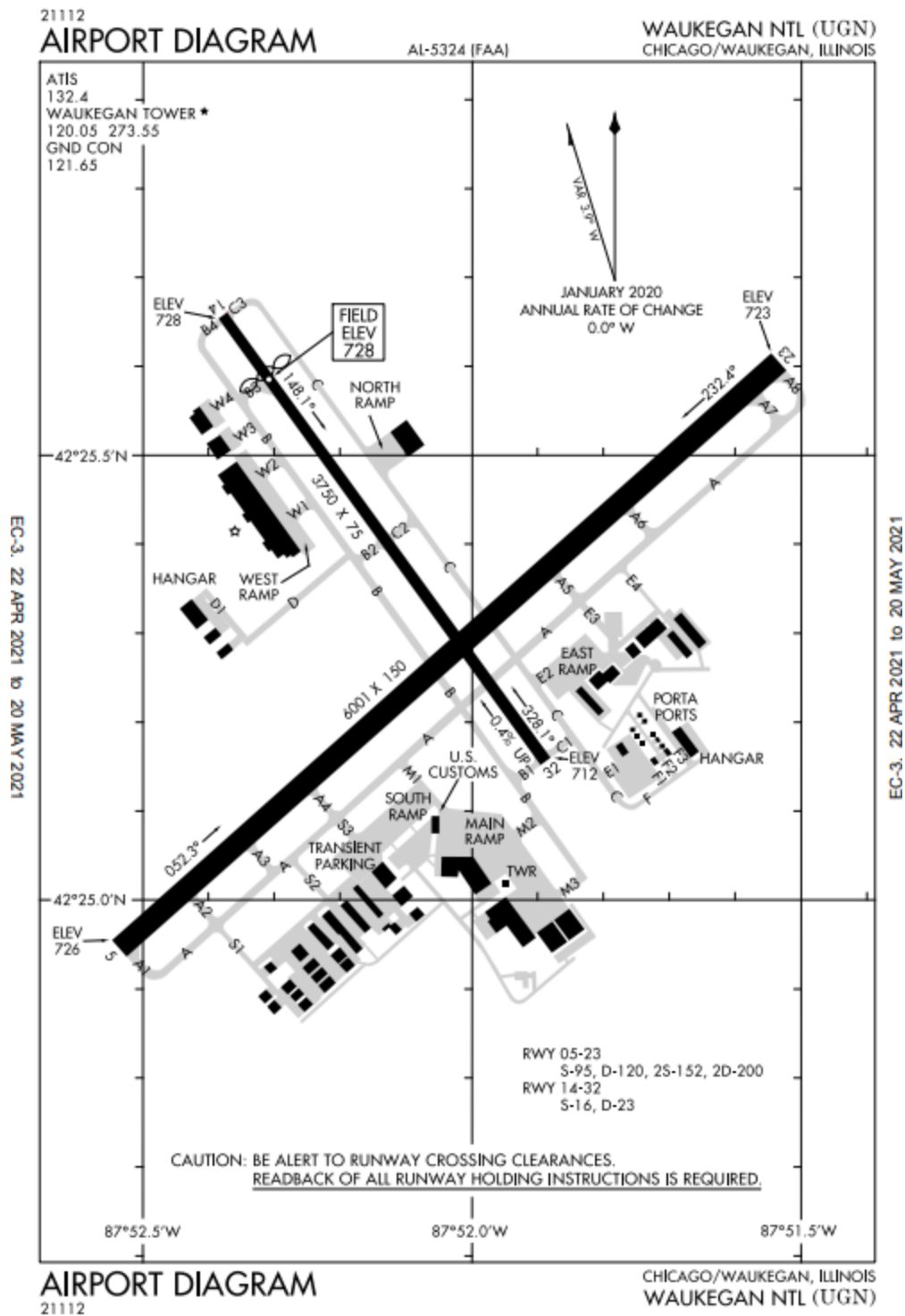

Figure A-12. Waukegan National Airport Diagram

The original (documented) construction of Runway 14/32 (Sections 2, 3, and 4A) occurred in 1965 and consisted of a 5-in. base course (P-154) with 6 in. of Portland cement concrete (PCC) pavement

(P-501). Addition length was added to the runway in 1969 (Sections 1 and 7), which consisted of a 6-in. subbase course (P-154), a 6-in. crushed aggregate base course (P-209), and 6-in. of PCC pavement (P-501). In 1974, the PCC pavement was removed in Sections 3 and 4A and replaced with a 6-in. bituminous base course (P-201) and 6 in. of PCC pavement (P-501). In 1994, the majority of the PCC pavement was cracked and sealed and overlaid with a 4.5-in. bituminous base course (P-201) and a 1.5-in. bituminous surface course (P-401). That rehabilitation was in service until the most recent rehabilitation, which occurred in 2010. The 2010 rehabilitation consisted of partial depth bituminous repair and a bituminous base leveling course (201) overlay with a depth that varied from 2 in. to 3 in. This was followed by a 1.5-in. surface course (401). A summary of the pavement history for Runway 14/32 can be found in Table A-1.

Table A-1 Runway 14/32 Pavement History

Section	Feature No.	Year	Description	IL Project No.	Old Pavement Treatment				
					Nothing	Removal	Mill	Crack & Seat	Rubblize
Runway 14/32 Section 2	40	1965	5" subbase course (154), 6" PCC pavement (501)	65A-5-352					
		1994	4.5" bituminous base course (201), 1.5" bituminous surface course (401)	94A-38-1789				All	
		2011	Partial depth bit repair, 2-3" var. bituminous base course (201), 1.5"-bituminous surface course (401)	UGN-3908					
Runway 14/32 Section 3	42	1965	5" subbase course (154), 6" PCC pavement (501)	65A-5-352					
		1974	Pavement removal, 6" bituminous base course (201), 6" PCC pavement (501)	74A-13-603		All			
		1994	4.5" bituminous base course (201), 1.5" bituminous surface course (401)	94A-38-1789				All	
		2011	Partial-depth bit repair, 2-3" var. bit base course (201), 1.5"-bit surface course (401)	UGN-3908					
Runway 14/32 Section 4A	43	1965	5" subbase course (154), 6" PCC pavement (501)	65A-5-352					
		1974	Pavement removal, 6"-bit base course (201), 6" PCC pavement (501)	74A-13-603		All			

Section	Feature No.	Year	Description	IL Project No.	Old Pavement Treatment				
					Nothing	Removal	Mill	Crack & Seat	Rubblize
		1994	4.5"-bit base course (201), 1.5" bit surface course (401)	94A-38-1789				All	
		1997	Butt joint	97A-45-2062					
		2011	Partial depth bit repair, 2-3" var. bit base course (201), 1.5"-bit surface course (401)	UGN-3908					
Runway 14/32 Section 1	66	1969	6" subbase course (154), 6" crushed agg base course (209), 6" PCC pavement (501)	69A-9-440					
		1994	4.5"-bit base course (201), 1.5"-bit surface course (401)	94A-38-1789					
		2011	Partial depth bit repair, 2-3" var. bit base course (201), 1.5"-bit surface course (401)	UGN-3908					
Runway 14/32 Section 7	67	1969	6" subbase course (154), 6" crushed aggregate base course (209), 6" PCC pavement (501)						
		1995	3.5"- & var. depth-bit base course (201), 1.5"-bit surface course (401)				All		
		2011	Partial depth bit repair, 2-3" var.-bit base course (201), 1.5"-bit surface course (401)						

Plans and Specifications

Runway 14/32

Construction plans and specifications were provided by the Illinois Department of Transportation, Division of Aeronautics. The design consultant for this project was Hanson Professional Services, Inc., located in Oakbrook, Illinois. The scope of the project was to repair and overlay Runway 14/32, under AIP Project No. 3-17-0105-B44 and IDA Project No. UGN-3908.

The plans included a site plan, typical sections and pavement repair details, plan and profile sheets, cross-sections, pavement marking plans, lighting, electrical, etc.

The rehabilitation of Runway 14/32 consisted of partial-depth bituminous repair and a bituminous base leveling course overlay with a depth that varied from 2 in. to 3 in. (P-201). This was followed by a 1.5-in. surface course, with the quantities and item numbers as shown in Table A-2:

Table A-2. Runway 14/32 Bid Quantities

Item No.	Description	Unit	As Bid	Adjusted
AR201610	Bituminous base course	Ton	5,045	4,127
AR401610	Bituminous surface course	Ton	3,035	2,790

The typical section for the runway can be found in Figure A-13.

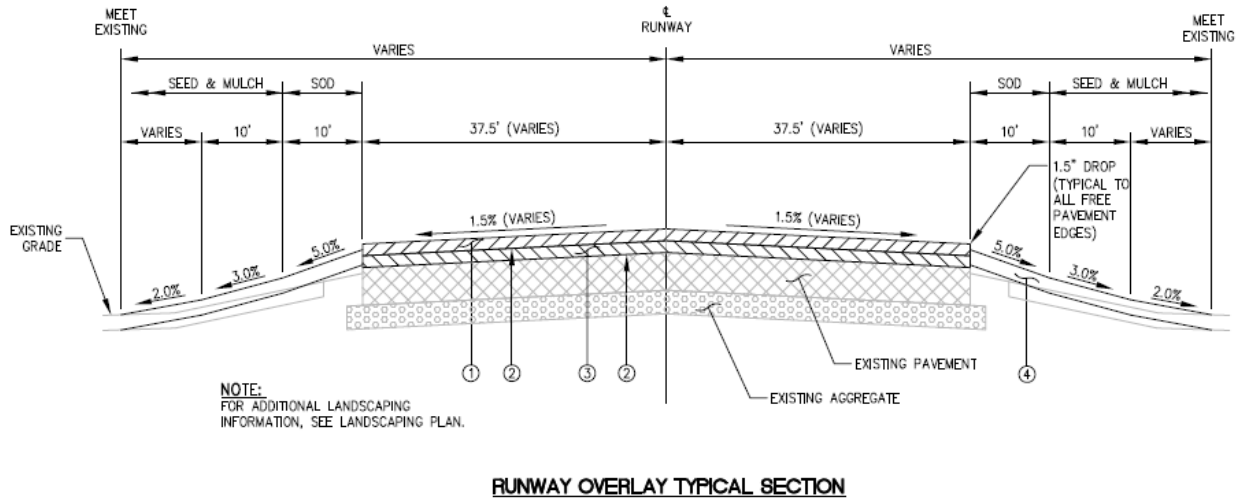

OVERLAY LEGEND	
①	PROPOSED 1.5 INCH BITUMINOUS SURFACE COURSE, ITEM AR401610.
②	PROPOSED BITUMINOUS TACK COAT, ITEM AR603510.
③	PROPOSED BITUMINOUS BASE LEVELING COURSE (DEPTH VARIES APPROXIMATELY 2" TO 3"), ITEM AR201620.
④	PROPOSED TOPSOIL, ITEM AR905520. SEEDING AND MULCHING AREAS, ITEMS AR901510 AND AR908510.

Figure A-13. Runway Overlay Typical Section

In addition to the overlay, there were also isolated spot repair areas, consisting of either partial depth bituminous repair or bituminous pavement removal and replacement. These areas appeared intermittently throughout the pavement.

The Illinois Department of Transportation, Division of Aeronautics Standard Specifications for Construction of Airports specifications were used for the project.

Mix Design

The base mix (A39081BB) was a fine-graded 19.0-mm mix with an N_{design} of 30 gyrations. The optimum binder content was 5.1%, and the mixture contained 20% RAP. The design air voids were 2.0% with a corresponding voids in the mineral aggregate (VMA) of 12.4%. The binder grade was a PG 64-22, supplied by BP Amoco.

The bituminous surface course mix (Mix Design No. A39081SB) was a coarse-graded 9.5-mm mix with an N_{design} of 30 gyrations. The optimum binder content was 6.2%, and the mixture contained no RAP. The design air voids were 2.0% with a corresponding VMA of 14.0%. The binder grade was a PG 64-22 supplied by BP Amoco.

All mix designs were approved by the Illinois Division of Aeronautics.

The mix for the project was produced by Curran Contracting of Crystal Lake, Illinois.

Construction Report

The Notice-to-Proceed on the project was given on October 17, 2009, and the project was substantially completed on September 15, 2010. The project was suspended from October 17, 2009 through June 1, 2010. Therefore, the work on the project occurred between June 1, 2010, and September 15, 2010.

Quality Control and Acceptance Results

The QC and acceptance data that were available met all the established specification criteria, and all lots were accepted at 100% pay.

Pavement performance data

For pavement-evaluation purposes, the runway is divided into seven sections. Based on Pavement Management Reports provided by APTEch, the most recent average PCI for Runway 14/32 was 65.6, rated in 2019. The highest rating was a 71, and the lowest of the seven sections was a 61. A plot of the average PCI ratings since the project was completed is shown in Figure A-14.

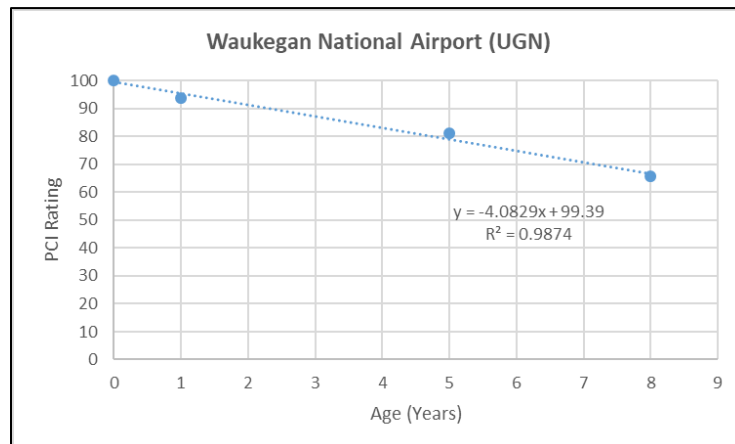

Figure A-14. PCI Ratings

The most prevalent types of distress throughout the seven sections include weathering, medium-severity joint reflective cracking, and medium-severity longitudinal and transverse cracking. Most of the distress deducts are associated with climate, with a small percentage associated with “other.” None of the deducts are associated with load.

History of preventive or maintenance activities conducted on the airfield

There were no records of any preventative maintenance activities conducted on the project.

Aircraft load and traffic data

Based on the ADIP, the overall airport traffic operation per year is as follows:

- Air carrier: 1
- Air taxi: 3,792
- General aviation local: 19,231
- General aviation itinerant: 21,130
- Military: 861
- TOTAL OPERATIONS: 45,015

Based on the ADIP, Runway 14/32 is subjected to the following loads:

- Single wheel: 16,000 lb
- Dual wheel: 23,000 lb

Edgar County Airport

Owner: Sup Board of Edgar County

Manager: Tom Tuttle

Address: 15551 Airport Road, Paris, IL 61944

Phone: 217-466-7433

Description of the Airport

The Edgar County Airport (PRG) is owned by Edgar County, Illinois. It is in Edgar County, approximately 40 miles southeast of Champaign, Illinois and 75 miles west of Indianapolis, Indiana. The airport has an FAA service level classification of General Aviation. The airport covers 180 acres and at an elevation of 654 ft. It has two runways: 09/27, which is 4,501 ft x 75 ft, and 18/36, which is 3,200 ft x 75 ft (Figure A-15). This report focuses on Runway 18/36.

Runway 18/36

- PCN: NA
- Dimensions: 3,200 ft x 75 ft
- Construction of Crosswind Runway 18/36 (Illinois Division of Aeronautics Specifications)
- AIP Project No. 3-17-0077-B13, IDA Project No. PRG-4018
- Initial construction date October 2012



Figure A-15. Map View of Edgar County Airport (Google Maps)

Plans and Specifications

Runway 18/36

The Illinois Department of Transportation, Division of Aeronautics provided construction plans (as-builts) and specifications . The design consultant for the project was Hanson Professional Services, Inc. The scope of the project was the construction of a new runway under Illinois Project No. PRG-4018. The plans included a safety plan, stormwater pollution prevention plan, staging and construction sequencing plans, typical sections, plan and profile sheets, drainage plans, cross-sections, pavement marking plans, lighting, electrical, etc.

Construction of Runway 18/36 consisted of 16 in. of lime stabilized subgrade (AR 152), 6 in. of crushed aggregate base (AR 209), 2.5 in. of asphalt base course (AR 403), and 1.5 in. of asphalt surface course (AR 401). A summary of relevant quantities and pay items are shown in Table A-3.

Table A-3 Runway 18/46 Bid Quantities

Item No.	Description	Unit	Estimated Quantity	As-Built Quantity
AR155616	Soil processing-16"	SY	31,115	31,115
AR209510	Crushed aggregate base course	Tons	10,884	9,855
AR403614	Bituminous base course—Superpave	Tons	4,904	4,949
AR401614	Bituminous surface course—Superpave	Tons	2,958	2,979

The typical section for the main portion of Runway 18/36 and associated legend can be found in Figures A-16 and A-17.

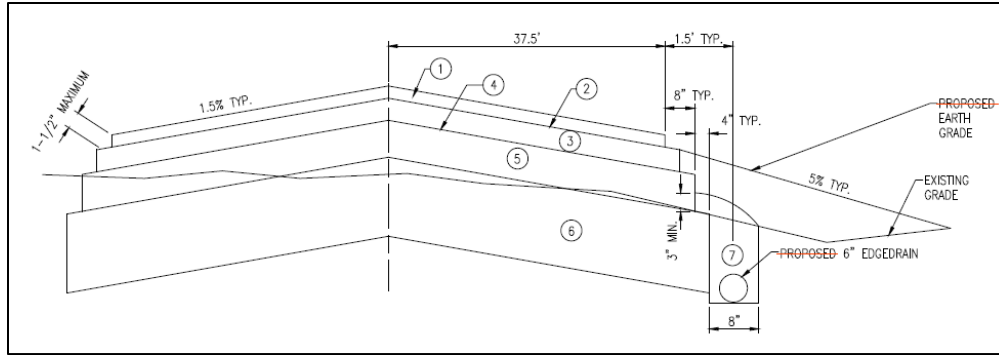

Figure A-16. Typical Section for Runway 18/36

LEGEND FOR N-S RUNWAY, NORTH AND SOUTH TURNAROUND TYPICAL SECTIONS	
①	PROPOSED AR 401 - BITUMINOUS SURFACE COURSE (1-1\2" DEPTH)
②	PROPOSED AR 603 - BITUMINOUS TACK COAT (0.05-0.15 GAL./S.Y.)
③	PROPOSED AR 403 - BITUMINOUS BASE COURSE (2-1\2" DEPTH)
④	PROPOSED AR 602 - BITUMINOUS PRIME COAT (0.35 GAL./S.Y.)
⑤	PROPOSED AR 209 - CRUSHED AGGREGATE BASE COURSE 6" DEPTH)
⑥	PROPOSED AR 152 - BY-PRODUCT LIME MODIFICATION (16" DEPTH)
⑦	PROPOSED AR 705 - POROUS BACKFILL

Figure A-17. Typical Section Legend

Mix Design

The bituminous base course mix (Mix Design No. A40181BB) was a coarse-graded 19.0 mm mix with an N_{design} of 30 gyrations. The optimum binder content was 4.8%, and the mixture contained 15% RAP. The design air voids were 2.0% with a corresponding VMA of 11.6%. The binder grade was a PG 64-22 supplied by Emulsicoat, Inc.

The bituminous surface course mix (Mix Design No. A40181SB) was a coarse-graded 9.5 mm mix with an N_{design} of 30 gyrations. The optimum binder content was 6.2%, and the mixture contained no RAP. The design air voids were 2.0% with a corresponding VMA of 14.6%. The binder grade was a PG 64-22 supplied by Emulsicoat, Inc.

All mix designs were approved by the Illinois Division of Aeronautics.

The mix for the project was produced by Open Road Asphalt of Fairmount, Illinois.

Construction Report

The Notice-to-Proceed for the project was issued on July 27, 2011. Construction began August 5, 2011. The project was substantially completed on October 19, 2012. Final acceptance was on June 21, 2013. No additional construction reports were available.

Quality Control and Acceptance Results

The QC and acceptance data that were available met all the established specification criteria, and all density lots were accepted at 100% pay.

Pavement performance data

Based on Pavement Management Reports provided by APTech, the most recent average PCI for Runway 18/36 was 76, rated in 2019. A plot of the average PCI ratings since the project was completed is shown in Figure A-18.

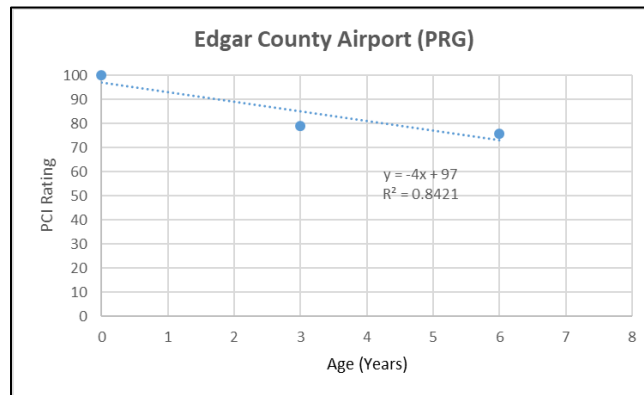

Figure A-18. Edgar County Airport Project Average PCI Ratings

The two most prevalent types of distresses were medium- and low-severity longitudinal and transverse cracking. Weathering was also a noted distress. All the distress deducts on the project were associated with climate. No deducts were associated with load.

History of preventive or maintenance activities conducted on the airfield

There were no records of any preventative maintenance activities conducted on the project.

Aircraft load and traffic data

Based on the ADIP, the overall airport traffic operation per year is as follows:

- Air carrier: 0
- Air taxi: 50
- General aviation local: 3,350
- General aviation itinerant: 3,500
- Military: 0
- TOTAL OPERATIONS: 6,900

The ADIP did not include any load data on either of the runways at this airport.

Bolingbrook's Clow International Airport

Owner: Village of Bolingbrook

Manager: Joseph DePaulo

Address: 375 W Briarcliff Road, Bolingbrook, IL 60440

Phone: 630-226-8400

Description of the Airport

Bolingbrook's Clow International Airport (1C5) is a public airport in Bolingbrook, a village in Will County, Illinois. It is general aviation facility located 29 miles southwest of Chicago. The airport covers an area of 205 acres at an elevation of 675 ft, and has one runway, 18/36 (Figure A-19).

Runway 18/36

- PCN: NA
- Dimensions: 3,360 ft x 75 ft
- Construct Replacement Runway 18/36 (Illinois Division of Aeronautics Specifications)
- IDA Project No. 1C5-4303; AIP Project No. 3-17-SBGP-91, 94, 99, 105N
- Project substantially completed May 2016

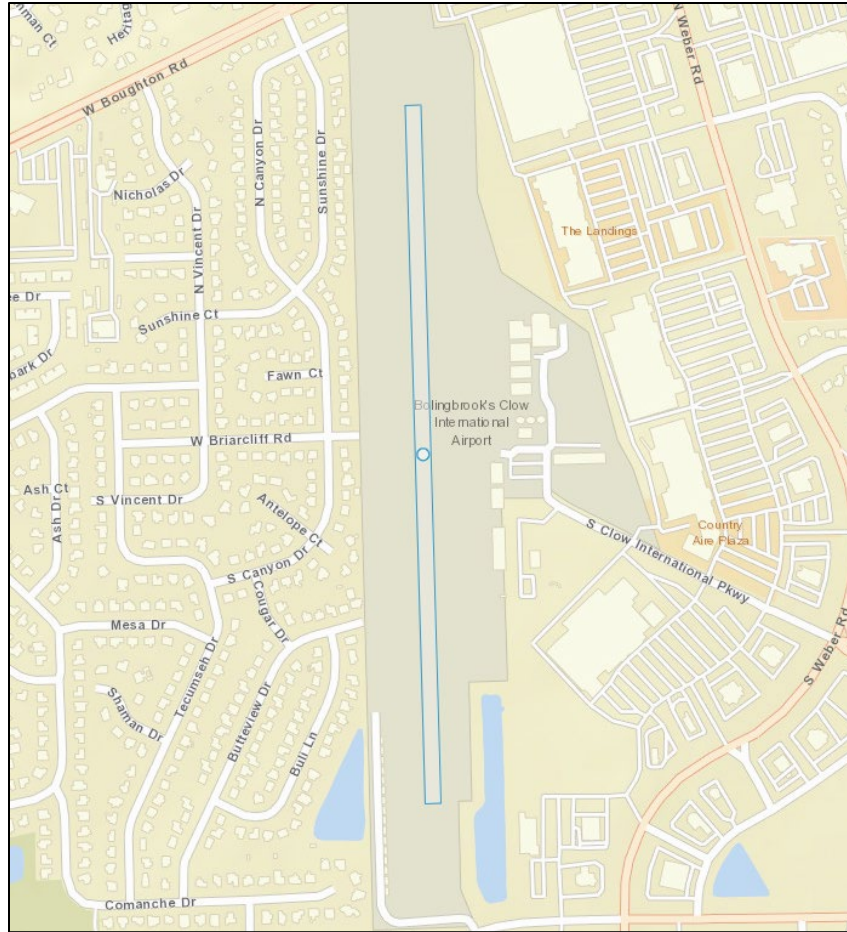

Figure A-19. Map View of Bolingbrook's Clow International Airport

Plans and Specifications

Runway 18/36

The Illinois Department of Transportation, Division of Aeronautics provided construction plans (as-builts) and specifications . The plans included a site plan, construction and safety notes, phasing plan, typical sections and pavement details, a storm water pollution prevention plan, plan and profile sheets, drainage plans, cross-sections, pavement marking plans, lighting, electrical, etc.

The design consultant for the project was Hanson Professional Services, Inc. The scope of the project was the construction of a new runway under Illinois Project No. 1C5-4303.

This rehabilitation consisted of the removal of the existing runway and connecting taxiway pavements, followed by the placement of a 6-in. granular drainage subbase (AR 800), 6 in. of crushed aggregate base (AR209), 4 in. of bituminous base course (AR403), and 2 in. of bituminous surface course (AR401). A summary of quantities and Item Numbers are shown in Table A-4.

Table A-4. Runway 18/36 Bid Quantities

Item No.	Description	Unit	As Bid	Adjusted
AR800927	Granular drainage subbase 6"	SY	35,211	35,211
AR209606	Crushed aggregate base course 6"	SY	35,253	35,253
AR403614	Bituminous base course—Superpave	Tons	8,095	8,095
AR401614	Bituminous surface course—Superpave	Tons	4,051	4,051

The typical section for Runway 18/36 and associated legend can be found in Figures A-20 and A-21.

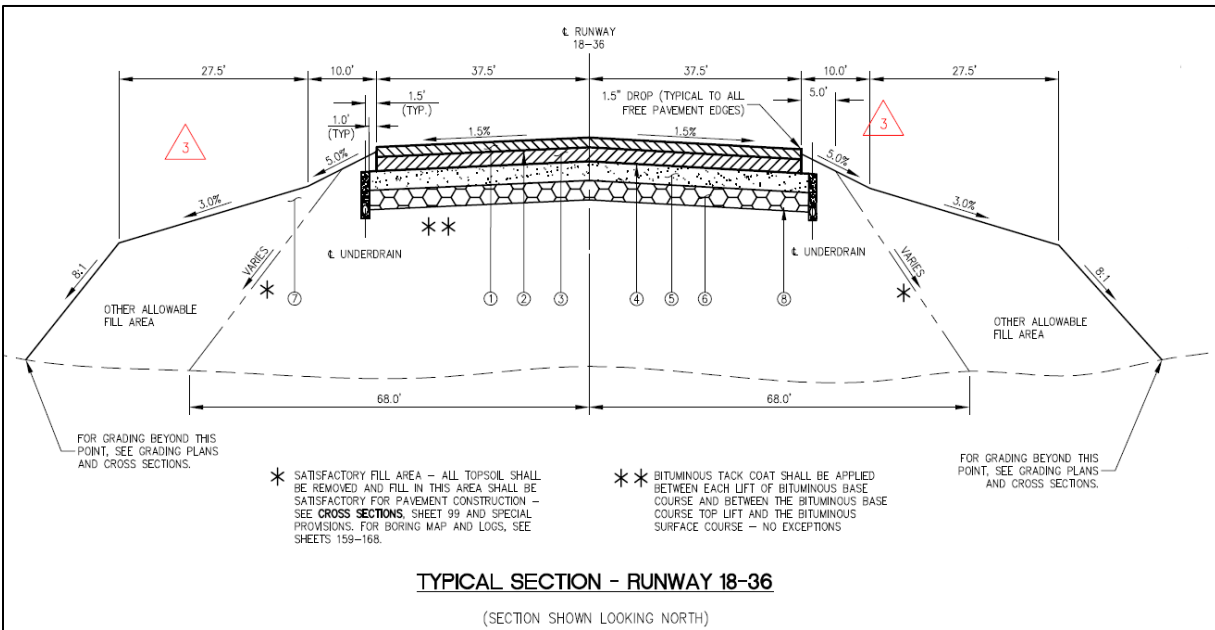

Figure A-20. Typical Section for Runway 18/36

①	PROPOSED 2 INCH BITUMINOUS SURFACE COURSE, ITEM AR401614
②	PROPOSED BITUMINOUS TACK COAT, ITEM AR603510 (BETWEEN ALL LIFTS, .15 GALLONS/SQUARE YARD)
③	PROPOSED 4 INCH BITUMINOUS BASE COURSE, ITEM AR403614
④	PROPOSED BITUMINOUS PRIME COAT, ITEM AR602510 (.30 GALLONS/SQUARE YARD)
⑤	PROPOSED 6 INCH CRUSHED AGGREGATE BASE COURSE, ITEM AR209606
⑥	PROPOSED 6 INCH GRANULAR DRAINAGE SUBBASE, ITEM AR800927
⑦	PROPOSED 4 INCH TOPSOIL, ITEM AR905510
⑧	PROPOSED SEPARATION FABRIC, ITEM AR156513

Figure A-21. Typical Section Legend

Mix Design

The bituminous base course mix (Mix Design No. A43031BB) was a fine-graded 19.0-mm mix with an N_{design} of 30 gyrations. The optimum binder content was 4.9%, and the mixture contained

25% RAP. The design air voids were 2.0% with a corresponding VMA of 11.4%. The binder grade was a PG 64-22 supplied by Seneca Petroleum.

The bituminous surface course mix (Mix Design No. A43031SB) was a coarse-graded 9.5-mm mix with an N_{design} of 30 gyrations. The optimum binder content was 6.6%, and the mixture contained no RAP. The design air voids were 2.0% with a corresponding VMA of 14.7%. The binder grade was a PG 64-22 supplied by Seneca Petroleum.

All mix designs were approved by the Illinois Division of Aeronautics.

The mix for the project was produced by D Construction, Inc. of Coal City, Illinois.

Construction Report

The Notice-to-Proceed on the project was given on May 18, 2015, with the same start date. The project was suspended (winter) from December 10, 2015, through April 25, 2016. The project was substantially completed on May 6, 2016, with final acceptance on September 23, 2016.

Quality Control and Acceptance Results

The available QC and acceptance data met all the established specification criteria, and all lots were accepted at 100% pay. For the base mix, the target binder content was increased at the beginning of Lot 2 from 4.9% up to 5.1% because of high gyratory compacted air voids.

Pavement performance data

Based on Pavement Management Reports provided by APTech, the most recent average PCI for Runway 18/36 was 79, rated in 2019. A plot of the average PCI ratings since the project was completed is shown in Figure A-22.

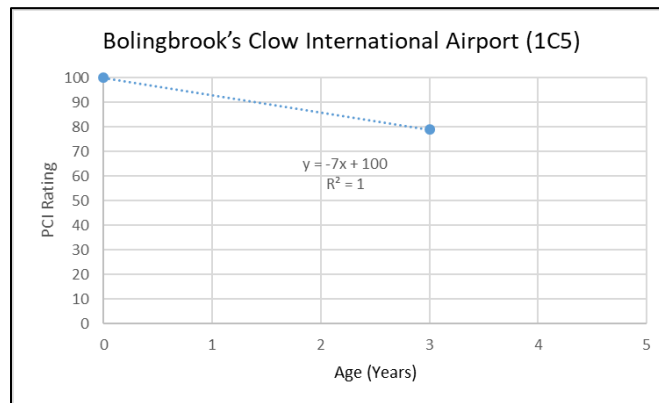

Figure A-22. Bolingbrook's Clow International Airport Project Average PCI Ratings

The three most prevalent types of distresses were low-severity longitudinal and transverse cracking, raveling, and weathering. All the distress deducts on the project were associated with climate. None of the deducts were associated with load.

History of preventive or maintenance activities conducted on the airfield

There are no records of any preventative maintenance activities conducted on the project.

Aircraft load and traffic data

Based on the ADIP, the overall airport traffic operations per year is as follows:

- Air carrier: 0
- Air taxi: 2,000
- General aviation local: 26,000
- General aviation itinerant: 22,000
- Military: 0
- TOTAL OPERATIONS: 50,000

Based on the ADIP, Runway 18/36 is subjected to the following loading:

- Single wheel: 12,500 lb

DuPage Airport

Owner: DuPage Airport Authority

Manager: Mark Doles

Address: 2700 International Drive, Suite 2, West Chicago, IL 60185

Phone: 630-584-2211

Description of the Airport

DuPage Airport (DPA) is a general aviation airport located 29 miles west of downtown Chicago in West Chicago, DuPage County, Illinois. It is owned and operated by the DuPage Airport Authority, which is an independent government body established by law by the State of Illinois. It also serves as a relief airport for O'Hare International Airport and Chicago Midway International Airport, both in nearby Chicago. The airport has an FAA service-level classification as Reliever.

The airport covers 2,800 acres and sits at an elevation of 759 ft. The airport has four runways (see Figure A-23): 02L/20R (7,571 ft x 150 ft), 02R/20L (6,451 ft x 100 ft), 10/28 (4,750 ft x 75 ft), and 15/33 (3,399 ft x 100 ft). Runway 10/28 is the focus of this report.

Runway 10/28

- PCN: NA
- Dimensions: 4,750 ft x 75 ft
- Most recent rehabilitation date: 2013
- Runway 10/28 East and Associated Taxiway Connector Overlay (Illinois Division of Aeronautics Specifications)
- AIP Project No. 3-17-0017-B25, IDA Project No. DPA-4122

The existing runway (prior to rehabilitation) had two predominant typical sections. The first consists of 6 in. on granular base, 6-in. PCC, 9.25 in. of asphalt, and 0.75-in. porous friction course. The second typical section consists of 6-in. crushed aggregate base, 4-in. asphalt treated permeable base, 9.25 in. of asphalt, and a 0.75-in. porous friction course.

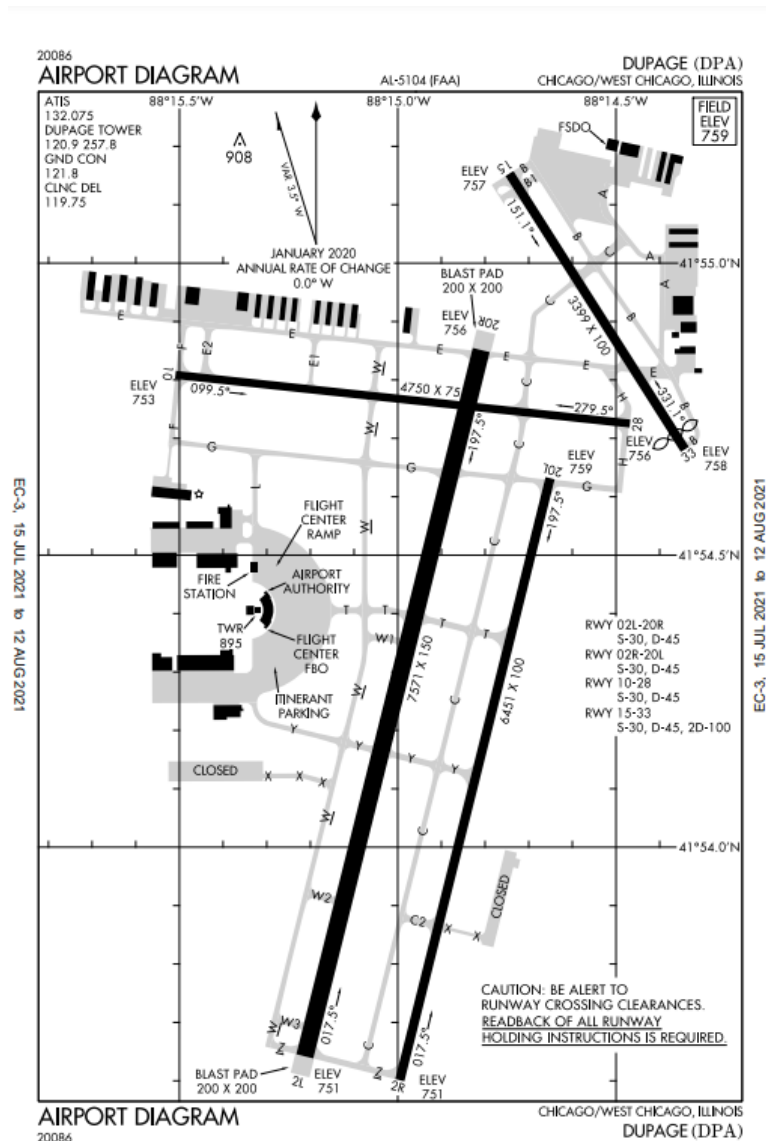

Figure A-23. DuPage Airport

Plans and Specifications

Runway 10/28

Construction plans and specifications were provided by the Illinois Department of Transportation, Division of Aeronautics. The design consultant for the project was CH2MHill. Consulting Engineers. The scope of the project was the overlay of Runway 10/28 East and the associated taxiway connector.

The plans included construction safety notes, safety plan, work area plans, typical sections, sequencing of construction, stormwater pollution-prevention plans, typical sections, plan and profile sheets, cross-sections, pavement marking plans, lighting, electrical, etc.

The rehabilitation of Runway 10/28 consisted of variable depth milling (1.25 in. at centerline to 2 in. at the pavement edge), followed by the placement of a 1-in. leveling course (P-401), and a 2-in. bituminous surface course (P-401). The summary of relevant quantities and pay items is shown in Table A-5.

Table A-5. Runway 10/28 Bid Quantities

Bid Item No.	Description	Units	Quantity
AR401650	Bituminous pavement milling	SY	18,036
AR401620	Bituminous surface course, leveling	Tons	326
AR401610	Bituminous surface course	Tons	2,350
AR401640	Bituminous pavement grooving	SY	9,594

The typical section for the main portion of Runway 10/28 and associated legend can be found in Figures A-24 and A-25.

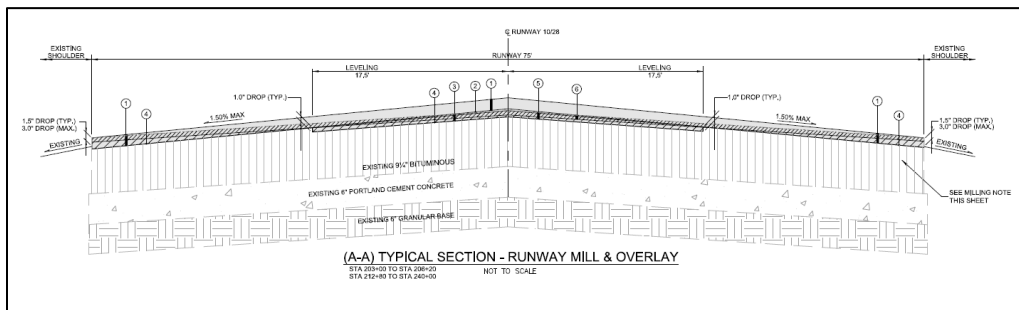

Figure A-24. Runway 10/28 Typical Section

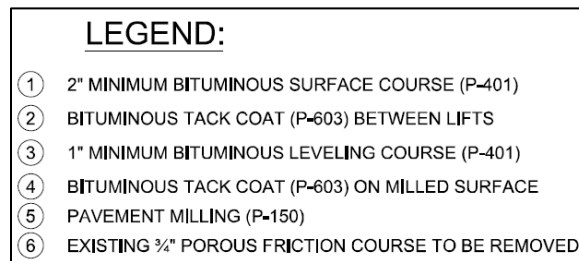

Figure A-25. Typical Section Legend

Mix Design

The bituminous surface course mix (Mix Design No. A4122---1SB) was a fine-graded 9.5-mm mix with an N_{design} of 40 gyrations. The optimum binder content was 6.1%, and the mixture

contained no RAP. The design air voids were 2.0% with a corresponding VMA of 14.1%. The binder grade was a PG 64-22 supplied by B. P. Amoco.

All mix designs were approved by the Illinois Division of Aeronautics.

The mix for the project was produced by Allied Asphalt out of West Chicago, Illinois.

Construction Report

The letting date for the project was September 21, 2012. Although there is no available contract information, the mix design was approved on May 7, 2013. From test data, it appears the mix was produced and placed in the period between May 13, 2013, and May 29, 2013.

Quality Control and Acceptance Results

The available QC and acceptance data met all the established specification criteria, and all lots were accepted at 100% pay.

Pavement performance data

For pavement-evaluation purposes, the runway is divided into two sections. Based on Pavement Management Reports provided by APTEch, the most recent average PCI for Runway 10/28 was 80, rated in 2020, with the rating for both sections 78 and 82. A plot of the average PCI ratings since the project was completed is shown in Figure A-26.

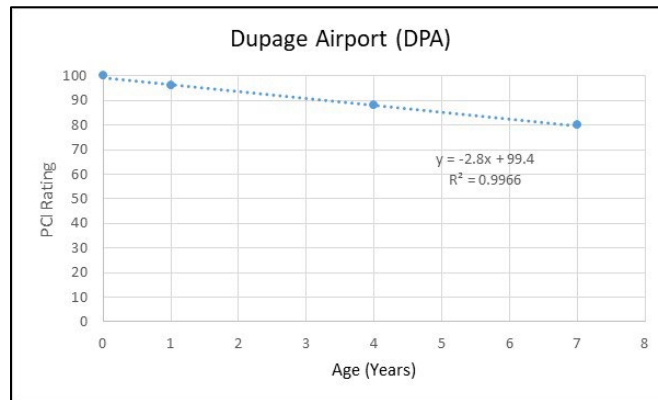

Figure A-26. DuPage Airport Project Average PCI Rating

The primary modes of distress include low-severity longitudinal and transverse cracking, low-severity alligator cracking, and low-severity weathering. With respect to distress deducts, 64% were climate related whereas 36% were load related.

History of preventive or maintenance activities conducted on the airfield

There were no records of any preventative maintenance activities conducted on the project.

Aircraft load and traffic data

Based on the ADIP, the overall airport traffic operation per year is as follows:

- Air carrier: 0
- Air taxi: 5,244
- General aviation local: 77,275
- General aviation itinerant: 50,356
- Military: 235
- TOTAL OPERATIONS: 133,110

Based on the ADIP, Runway 10/28 is subjected to the following loads:

- Single wheel: 30,000 lb
- Dual wheel: 45,000 lb

Chicago Executive Airport

Owner: Cities of Wheeling and Prospect Heights

Manager: George Sakas

Address: 1020 S. Plant Road, Wheeling, IL 60090

Phone: 847-537-2580

Description of the Airport

The Chicago Executive Airport (PWK) is jointly owned by the City of Prospect Heights and the Village of Wheeling. It is in Cook County, 21 miles northwest of downtown Chicago and 9 miles due north of O'Hare international Airport.

Chicago Executive Airport is the fourth-busiest airport in Illinois and has an FAA service level classification of Reliever. The airport covers more than 412 acres at an elevation of 647 ft, and has three active runways: 06/24, 12/30, and 16/34 (see Figure A-27). Runway 16/34 is the focus of this report.

Runway 16/34

- PCN: 39/F/D/X/T
- Dimensions: 5,001 ft x 150 ft
- Most recent rehabilitation: 2016
- Rehabilitation of Runway 16/34 (Illinois Division of Aeronautics Specifications)
- AIP Project No. 3-17-SBGP-120N, 120A, 125D and IDA Project No. PWK-4414

The original construction of Runway 16/34 was prior to 1969 and consisted of 6 in. to 8 in. of crushed aggregate base course (P-209) with 10 in. of asphalt surface course (P-401). In 1989, the runway was overlaid with an additional 2 in. of asphalt surface mix (P-401). In 2001, a crack control system was added, along with a variable depth asphalt leveling course (P-201), 2.5 in. of asphalt base course (P-201), and a 2-in. asphalt surface course (P-401). The most recent

rehabilitation occurred in 2016 and consisted of milling to a depth of 4 in. This was followed by the placement of 4 in. of asphalt surface mix (401) and pavement grooving. A history of the rehabilitation work completed is shown in Table A-6.

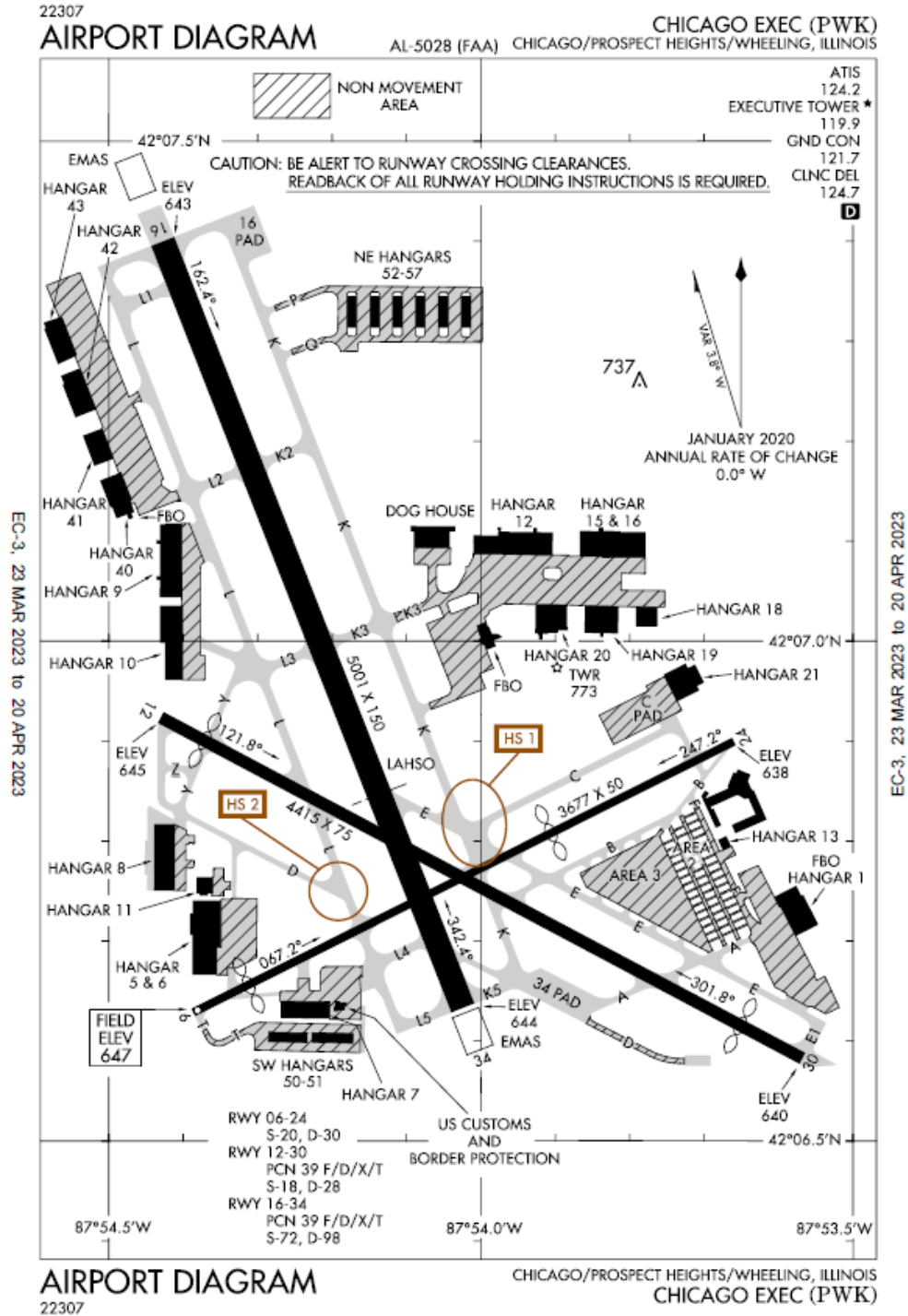

Figure A-27. Chicago Executive Airport

Table A-6. Runway 16/34 Pavement History

Section	Feature No.	Year	Description	IL Project No.	Old Pavement Treatment					Comments
					Nothing	Removal	Mill	Crack & Seat	Rubblize	
	1	< 1969	6"-8" crushed aggregate base course (209), 10" ave bit surface course (401)	NA						
		1989	2" bit surface course (401)	NA						
		1995	Pavement removal	95A-22-1945		All				
Runway 16-34 Section 1	2	< 1969	6"-8" crushed agg base course (209), 10" ave bit surface course (401)	NA						
		1989	2" bit surface course (401)	NA						
		2001	Ref. crack control-System A, var depth bit leveling cse(201), 4" bit base cse (201), 2" bit surf cse(401)	PWK-2804						
		2016	4" bit milling, 4" bit surface course (401), bit pavement grooving (401)	PWK-4414			4			
Runway 16-34 Section 4	3	<1969	6" crushed agg base course (209), 9" bit surface course (401)	NA						
		1989	2" bit surface course (401)	NA						
		2001	Ref. crack control-System A, var depth bit leveling cse(201), 2.5" bit base cse(201), 2" bit surf cse(401)	PWK-2804						
		2016	4" bit milling, 4" bit surface course (401), bit pavement grooving (401)	PWK-4414			4"			
Runway 16-34 Section 5	4	<1969	0"-6" crushed agg base course (209), 9" bit surface course (401)	NA						
		1989	2" bit surface course (401)	NA						
		2001	Ref. crack control-System A, var depth bit leveling cse(201), 2.5" bit base cse(201), 2" bit surf cse(401)	PWK-2804						
		2016	4" bit milling, 4" bit surface course (401), bit pavement grooving (401)	PWK-4414			4"			
Runway 16-34 Section 3	90	<1969	6" crushed agg base course (209), 9" ave bit surface course (401)	NA						
		1989	2" bit surface course (401)	NA						
		2001	6" & var depth bit agg mixture, 6" bit base course (201), 2" bit surface course (401)	PWK-2804						

Section	Feature No.	Year	Description	IL Project No.	Old Pavement Treatment					Comments
					Nothing	Removal	Mill	Crack & Seat	Rubblize	
		2016	4" bit milling, 4" bit surface course (401), bit pavement grooving (401)	PWK-4414			4"			
Runway 16-34 Section 2	102	<1969	6"-8" crushed aggregate base course (209), 10" ave bit surface course (401)	NA						
		1989	2" bit surface course (401)	NA						
		2001	6" & var depth bit aggregate mixture, 6" bit base course (201), 2" bit surface course (401)	PWK-2804						
		2016	4" bit milling, 4" bit surface course (401), bituminous pavement grooving (401)	PWK-4414			4"			

Plans and Specifications

Runway 16/34

Construction plans and specifications were provided by the Illinois Department of Transportation, Division of Aeronautics. The design consultant for the project was Crawford, Murphy and Tilly, Inc., Consulting Engineers. The scope of the project was to rehabilitate Runway 16/34 under Illinois Project No. PWK-4414.

The plans included site plan, sequencing of construction, stormwater pollution prevention plans, typical sections, plan and profile sheets, cross-sections, pavement marking plans, lighting, electrical, etc.

The rehabilitation of Runway 16/34 consisted of milling 4 in. followed by the placement of 4 in. of asphalt surface course, which was placed in two 2-in. lifts. The final surface was then grooved. The summary of relevant quantities and pay items are as shown in Table A-7.

Table A-7. Runway 16/34 Bid Quantities

Item No.	Description	Unit	Estimated Quantity	Record Quantity
AR 401650	Bituminous pavement milling	SY	83,345	83,340
AR401601	Bituminous surface course	Tons	21,450	21,795
AR401640	Bituminous pavement grooving	SY	75,050	74,982

The typical section for the main portion of Runway 16/34, and the associated legend can be found in Figures A-28 and A-29.

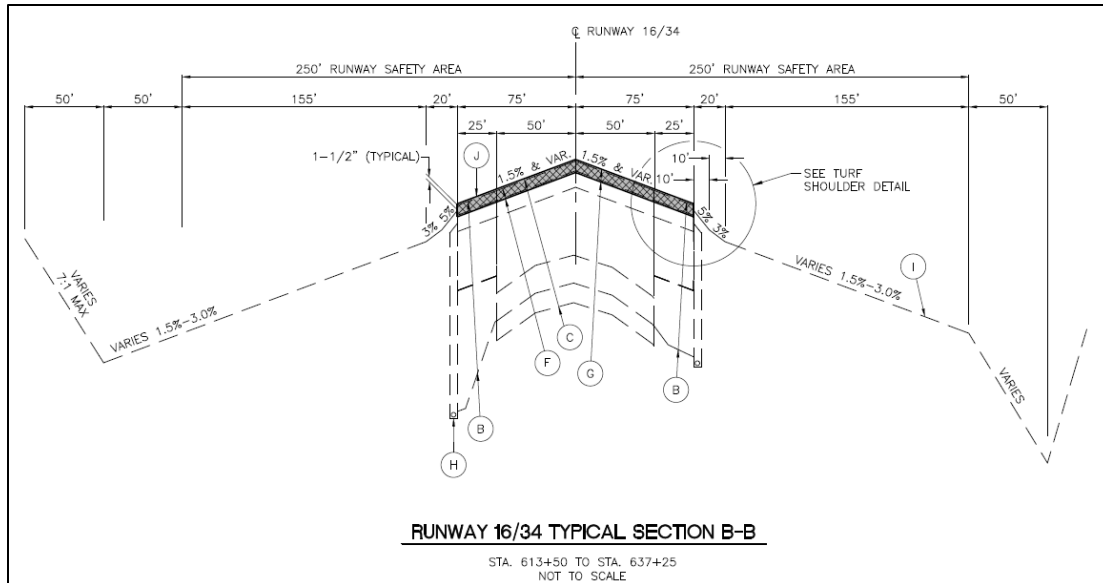

Figure A-28. Runway 16/34 Typical Section

LEGEND	
(A)	EXISTING 13" BITUMINOUS PAVEMENT (401/403) EXISTING 6" CRUSHED AGGREGATE BASE COURSE (209)
(B)	EXISTING 8" BITUMINOUS PAVEMENT (401/201) EXISTING 18" CRUSHED AGGREGATE BASE COURSE (209) EXISTING 6" AND VARIABLE POROUS GRANULAR EMBANKMENT (208)
(C)	EXISTING 22.5" BITUMINOUS PAVEMENT (401/201) EXISTING 6" CRUSHED AGGREGATE BASE COURSE (209)
(D)	EXISTING 14.5" BITUMINOUS PAVEMENT (401/403) EXISTING 6" CRUSHED AGGREGATE BASE COURSE (209)
(E)	EXISTING REFLECTIVE CRACK CONTROL – SYSTEM A (STRIP FABRIC)
(F)	BITUMINOUS PAVEMENT MILLING (3" – 4") (401650)
(G)	NEW 4" BITUMINOUS SURFACE COURSE (401) IN 2–2" LIFTS (TACK COAT BEFORE FIRST LIFT AND BETWEEN LIFTS)
(H)	EXISTING 6" CPPUP W/ SOCK, FILTER FABRIC ENVELOPE AND POROUS BACKFILL (705)
(I)	EXISTING GROUNDLINE
(J)	NEW BITUMINOUS PAVEMENT GROOVING (401640)

Figure A-29. Typical Section Legend

Mix Design

The bituminous surface course mix (Mix Design No. A44141SB) was a coarse-graded 9.5-mm mix with an N_{design} of 40 gyrations. The optimum binder content was 5.5%, and the mixture contained no RAP. The design air voids were 3.0% with a corresponding VMA of 13.6%. The binder grade was a PG 64-22 supplied by Seneca Petroleum. All mix designs were approved by the Illinois Division of Aeronautics. The mix for the project was produced by DuKane Asphalt of Addison, Illinois.

Construction Report

The contractor for the project was R.W. Dunteman Co. of Addison, Illinois. The project was let on January 15, 2016, and the Notice-to-Proceed on the project was given on June 10, 2016. Construction began June 10, 2016. The project was substantially completed on November 14, 2016. The final cost of the project was \$4,426,835.

Quality Control and Acceptance Results

The available QC and acceptance data met all the established specification criteria, and all lots were accepted at 100% pay.

Pavement performance data

For pavement-evaluation purposes, the runway is divided into five sections. Based on Pavement Management Reports provided by APTech, the most recent average PCI for Runway 16/34 was 80.8, rated in 2020. The highest rating of the five sections was an 83, and the lowest was a 79. A plot of the average PCI ratings since the project was completed is shown in Figure A-30.

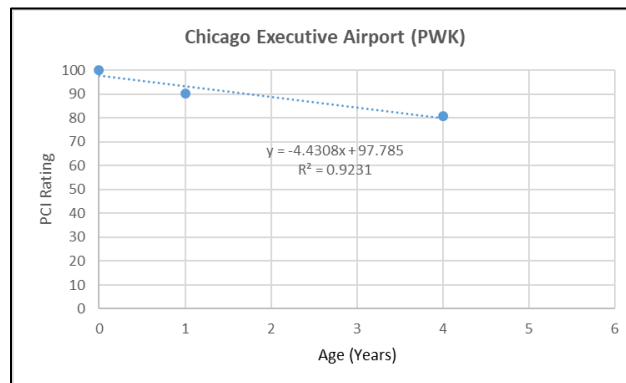

Figure A-30. Chicago Executive Airport Project Average PCI Ratings

The most prevalent types of distress throughout the five sections include low- and medium-severity longitudinal and transverse cracking and low- and medium-severity weathering. Also, one section had high-severity raveling. All the distress deducts on the project were associated with climate. No deducts were associated with load.

History of preventive or maintenance activities conducted on the airfield

There are no records of any preventative maintenance activities conducted on the project.

Aircraft load and traffic data

Based on the ADIP, the overall airport traffic operation per year is as follows:

- Air carrier: 48
- Air taxi: 13,232
- General aviation local: 19,397

- General aviation itinerant: 44,564
- Military: 80
- TOTAL OPERATIONS: 77,321

Based on the ADIP, Runway 06/24 is subjected to the following loads:

- Single wheel: 72,000 lb
- Dual wheel: 98,000 lb

Indiana

Anderson Municipal Airport

Owner: City of Anderson, IN

Manager: Brian McMillen

Address: 282 Airport Road, Anderson, IN 46017

Phone: 765-648-6292

Anderson Municipal Airport (AID) is 3 miles east of Anderson, in Madison County, Indiana. The National Plan of Integrated Airport Systems for 2011–2015 categorized it as a general aviation facility. The airport covers 619 acres at an elevation of 919 ft. It has two asphalt runways: 12/30 is 5,400 by 100 ft and 18/36 is 3,400 by 75 ft (see Figure A-31).

Taxiway A

Rehabilitation and Overlay Taxiway A (FAA Specifications) sections 5, 10 and 15 completed in:

- Construction of western portion of Taxiway A - 2006
- Construction of eastern portion of Taxiway A - 2008
- Construction of central portion of Taxiway A - 2008

Plans and Specifications

No plans or specifications were acquired for this project.

Mix design

No information on mix design submittals and acceptance criteria were provided.

Construction Report

No information of contractor, schedule, notations, delays, etc., were obtained for this project.

Quality Control and Acceptance Results

No information related to laboratory and field results were obtained for this project.

21112
AIRPORT DIAGRAM

AL-5133 (FAA) **ANDERSON MUNI-DARLINGTON FLD (AID)**
 ANDERSON, INDIANA

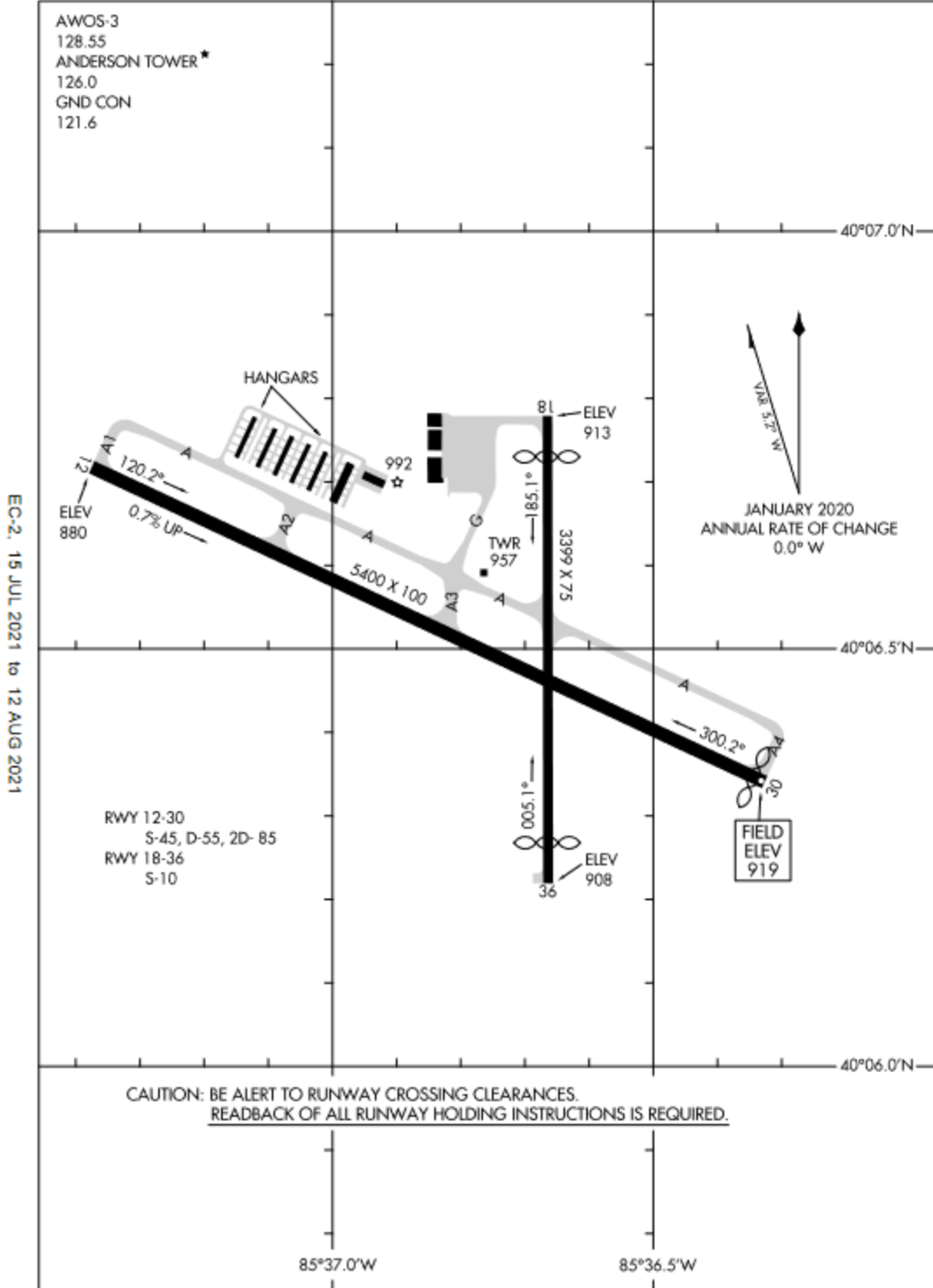

21112
AIRPORT DIAGRAM

ANDERSON, INDIANA
ANDERSON MUNI-DARLINGTON FLD (AID)

Figure A-31. Anderson Municipal Airport Diagram (source www.aopa.org)

Pavement performance data

Based on the Pavement Management Reports provided by APTEch, in 2019:

Section 05 had a PCI of 58. Low-severity longitudinal and transverse (L&T) cracking was observed in an unsealed condition, whereas medium-severity L&T cracking was recorded where unsealed crack widths exceeded 1/4 in. Low-severity raveling and weathering were also observed during the inspection.

Section 10 had a PCI of 72. Low-severity L&T cracking was observed in an unsealed condition, whereas medium-severity L&T cracking was recorded where unsealed crack widths exceeded 1/4 in. Low-severity weathering was recorded in areas where asphalt binder and fine material appeared to be missing, leaving the surface of the coarse aggregate exposed. High-severity L&T cracking was recorded in areas where the cracking had deteriorated substantially, producing areas of parallel secondary cracking wider than 1 ft.

Section 15 had a PCI of 61. Low-severity L&T cracking was identified in an unsealed condition. Medium-severity L&T cracking was recorded where the unsealed crack widths exceeded 1/4 in. Small amounts of low-severity rutting were observed. Low-severity weathering was recorded in areas where asphalt binder and fine material appeared to be missing, leaving the surface of the coarse aggregate exposed. A plot of the PCI ratings since the most recent rehabilitation is shown in Figure A-32.

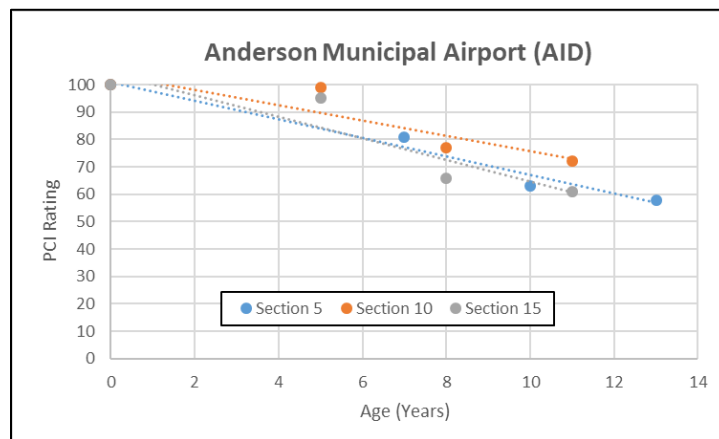

Figure A-32. Anderson Municipal Airport Project Average PCI Ratings

History of preventive or maintenance activities conducted on the airfield

No information related to any preventive or maintenance activities was reported since the project was finalized.

Aircraft load and traffic data

Based on the ADIP, the overall airport traffic operation per year is as follows:

- Air carrier: 0

- Air taxi: 1,162
- General aviation local: 9,292
- General aviation itinerant: 8,712
- Military: 193
- TOTAL OPERATIONS: 19,359

Based on the ADIP, Runway 12/30 (which is connected to Taxiway A) is subjected to the following loads:

- Single wheel: 45,000 lb
- Dual wheel: 55,000 lb
- Two dual wheels in tandem: 85,000 lb

Columbus Municipal

Owner: City of Columbus, IN

Manager: Brian Payne

Address: 4770 Ray Boll Boulevard, Columbus, IN 47203

Phone: 812-376-2519

Columbus Municipal Airport (BAK) is 3 miles north of Columbus, in Bartholomew County, Indiana. Columbus Municipal Airport covers 2,000 acres at an elevation of 656 ft. It has two runways: 5/23 is 6,400 ft x 150 ft, and 14/32 is 5,000 ft x 100 ft (Figure A-33).

Taxiway D

Rehabilitation of Taxiway D (FAA Specifications) sections 10 and 15 was completed in 2012.

Plans and Specifications

No plans or specifications were acquired for this project.

Mix design

No information on mix design submittals and acceptance criteria was provided.

Construction Report

No information of contractor, schedule, notations, delays, etc., was obtained for this project.

Quality Control and Acceptance Results

No information related to laboratory and field results was obtained for this project.

20366

AIRPORT DIAGRAM

AL-594 (FAA)

COLUMBUS MUNI (BAK)
COLUMBUS, INDIANA

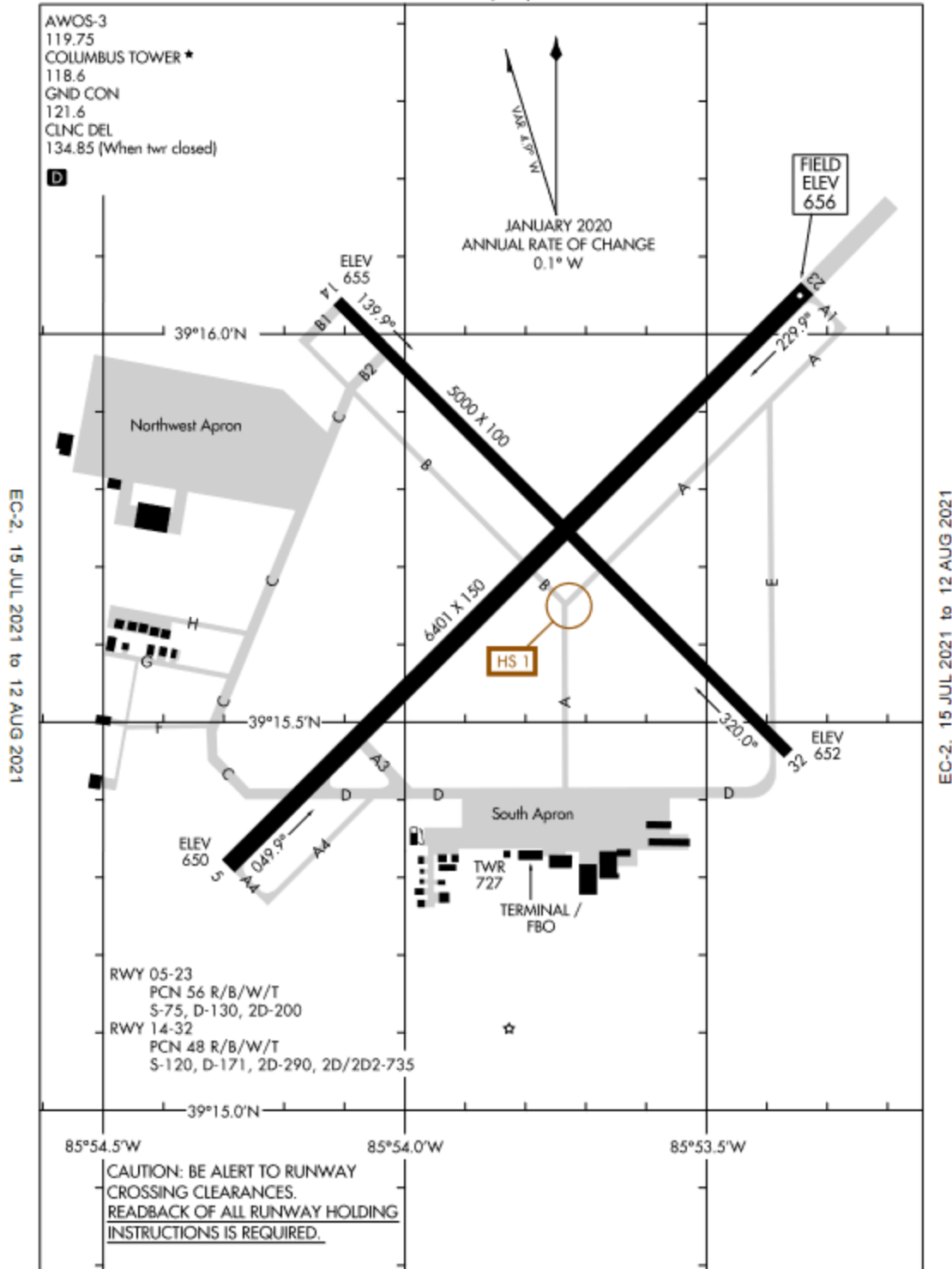

EC-2, 15 JUL 2021 to 12 AUG 2021

EC-2, 15 JUL 2021 to 12 AUG 2021

AIRPORT DIAGRAM

20366

COLUMBUS, INDIANA
COLUMBUS MUNI (BAK)

Figure A-33. Columbus Municipal Airport Diagram (source www.aopa.org)

Pavement performance data

Based on the Pavement Management Reports provided by APTEch, in 2019, Sections 10 and 15 were in similar condition and had PCIs of 85 and 86, respectively. Low-severity L&T cracking was identified in a sealed condition. Low-severity weathering was recorded where the asphalt binder had worn away from the surface of the coarse aggregate, and an oxidized pavement was identified. In addition, small amounts of medium-severity weathering were observed in Section 10, where the surface had been abraded from paint removal, leaving the coarse aggregate exposed.

History of preventive or maintenance activities conducted on the airfield

No information related to any preventive or maintenance activities was reported since the project was finalized.

Aircraft load and traffic data

Based on the ADIP, the overall airport traffic operation per year is as follows:

- Air carrier: 0
- Air taxi: 336
- General aviation local: 19,291
- General aviation itinerant: 20,157
- Military: 2,464
- TOTAL OPERATIONS: 42,248

Based on the ADIP, Runways are subjected to the following loads:

- Single wheel: 75,000 lb
- Dual wheel: 130,000 lb
- Two dual wheels in tandem: 200,000 lb

Logansport - Cass County

Owner: Logansport Cass Airport Authority

Manager: Jill VanHorn

Address: 3735 S. Airport Road, Logansport, IN 46947

Phone: 574-753-4300

Logansport/ Cass County Airport (GGP) is a public airport 2 miles south of Logansport, in Cass County, Indiana, at an elevation of 656 ft. Runway 09/27 is 5,400 x 150 ft (Figure A-34).

Runway 09/27

Rehabilitation of Runway 09/27 (FAA Specifications) was completed in 2003.

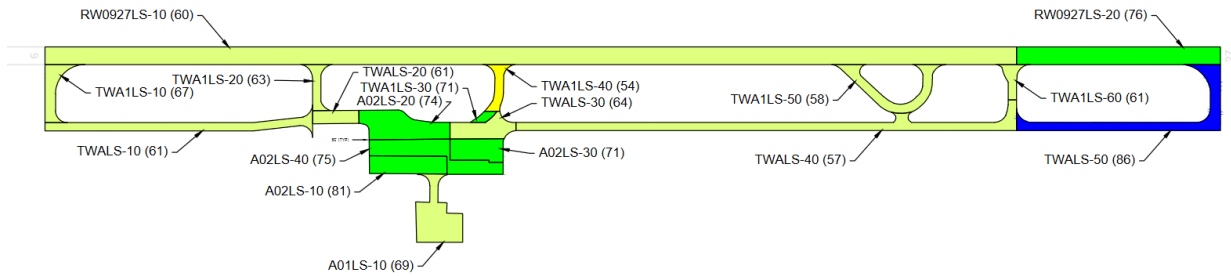

Figure A-34. Logansport Airport Diagram (source APTech)

Plans and Specifications

No plans or specifications were acquired for this project.

Mix design

No information on mix design submittals and acceptance criteria was provided.

Construction Report

No information of contractor, schedule, notations, delays, etc., was obtained for this project.

Quality Control and Acceptance Results

No information related to laboratory and field results was obtained for this project.

Pavement performance data

Based on the Pavement Management Reports provided by APTech, in 2018:

Runway 09/27 Section 10 had a PCI of 60. Low-, medium-, and high-severity L&T cracking, low-severity raveling, low-severity rutting, low-severity swelling, and low-severity weathering were observed during the inspection. Low-severity L&T cracking was observed in both an unsealed and sealed condition, whereas the medium-severity L&T cracking was recorded where crack sealant was no longer performing satisfactorily.

Runway 09/27 Section 20 had a PCI of 76. Low- and medium-severity L&T cracking, low-severity raveling, and low-severity weathering were recorded. Medium-severity L&T cracking was recorded where crack sealant no longer prevented water from penetrating the pavement surface, whereas the low-severity L&T cracking was observed in both a sealed and unsealed condition.

History of preventive or maintenance activities conducted on the airfield

No information related to any preventive or maintenance activities was reported since the project was finalized.

Aircraft load and traffic data

Based on the ADIP, the overall airport traffic operation per year is as follows:

- Air carrier: 0
- Air taxi: 159
- General aviation local: 3,439
- General aviation itinerant: 3,905
- Military: 313
- TOTAL OPERATIONS: 7,816

Based on the ADIP, Runways are subjected to the following loads:

- Single wheel: 20,000 lb

Peru Municipal Airport

Owner: Peru Boac

Manager: Kelly Wolf

Address: 1635 N. 400 W. Peru, IN 46970

Phone: 765-472-1990

Peru Municipal Airport (I76) is a public airport 4 miles (6.4 km) northwest of Peru, in Miami County, Indiana, at an elevation of 779 ft. Runway 1/19 is 5,400 x 75 ft (Figure A-35).

Runway 1/19

Reconstruction of Runway 1-19 (FAA Specifications) was completed in 2009.

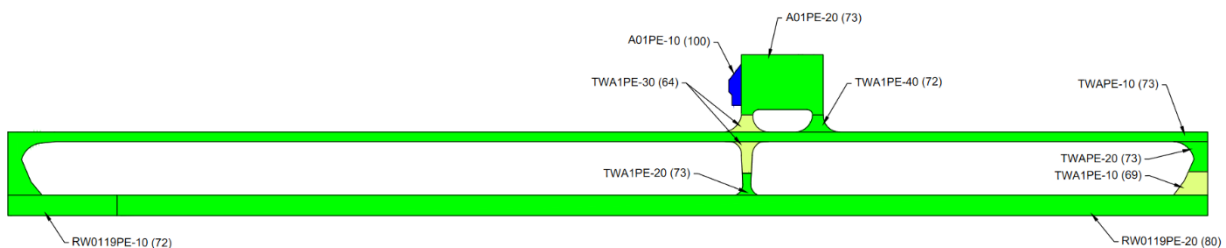

Figure A-35. Peru Municipal Airport Diagram (source APTech)

Plans and Specifications

No plans or specifications were acquired for this project.

Mix design

No information on mix design submittals and acceptance criteria was provided.

Construction Report

No information of contractor, schedule, notations, delays, etc., was obtained for this project.

Quality Control and Acceptance Results

No information related to laboratory and field results was obtained for this project.

Pavement performance data

Based on the Pavement Management Reports provided by APTEch, in 2018:

Runway 1/19 Section 10 had a PCI of 72. Medium-severity alligator cracking, low- and medium-severity depression, low- and medium-severity L&T cracking, and low-severity weathering were observed in the section. Low-severity L&T cracking was observed in both an unsealed and sealed condition, whereas the medium-severity L&T cracking was recorded where crack sealant was no longer performing satisfactorily.

Runway 1/19 Section 20 had a PCI of 80. Low-severity (both sealed and unsealed) L&T cracking, medium-severity L&T cracking, and low-severity weathering were identified during the inspection. Medium-severity L&T cracking was recorded where crack sealant failed and no longer prevented water from penetrating the pavement surface.

History of preventive or maintenance activities conducted on the airfield

No information related to any preventive or maintenance activities was reported since the project was finalized.

Aircraft load and traffic data

Based on the ADIP, the overall airport traffic operation per year is as follows:

- Air carrier: 0
- Air taxi: 0
- General aviation local: 1,910
- General aviation itinerant: 636
- Military: 0
- TOTAL OPERATIONS: 2,546

Based on the ADIP, Runways are subjected to the following loads:

- Single wheel: 10,000 lb

Michigan

Cheboygan County Airport

Owner: Cheboygan Airport Authority

Manager: Kevin Van Gordon

Address: 1520 Levering Road, Cheboygan, MI 49721

Phone: 231-627-5571

Description of the Airport

The Cheboygan County Airport (SLH) is a public-use airport located 2 miles west of the city of Cheboygan, in Cheboygan County, Michigan. It is owned by the Cheboygan Airport Authority. It is classified by the FAA as a general aviation facility. The airport covers more than 350 acres at an elevation of 640 ft and has two active runways, 17/35 and 10/28 (Figure A-36). Runway 10/28 is the focus of this report.

Runway 10/28

- PCN: NA
- Dimensions: 4,005 ft x 75 ft
- Most recent rehabilitation: 2010
 - Construction of Runway 17/35 (Michigan specifications)
 - Project No. FM16-4-C21



Figure A-36. Cheboygan County Airport Map

Plans and Specifications

Runway 17/35

Minimal plans were located for the project. The design consultant was R.W. Armstrong and Associates. The scope of the project was essentially to construct a new runway. Specifications were from the Michigan Department of Transportation Airports Division, Standard Specification P-411.

The runway structure consists of 6 in. of aggregate base course (P-208), followed by the placement of two 1.5-in. layers of bituminous structural course.

The typical section for the runway can be found in Figures A-37 and A-38.

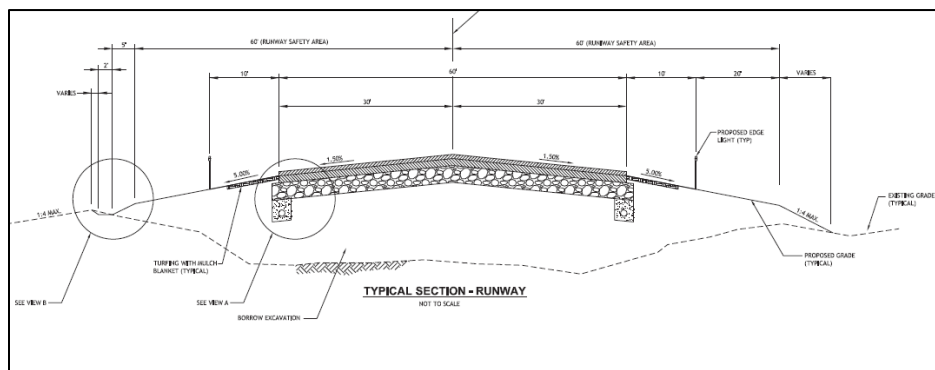

Figure A-37. Typical Section Runway 17/35

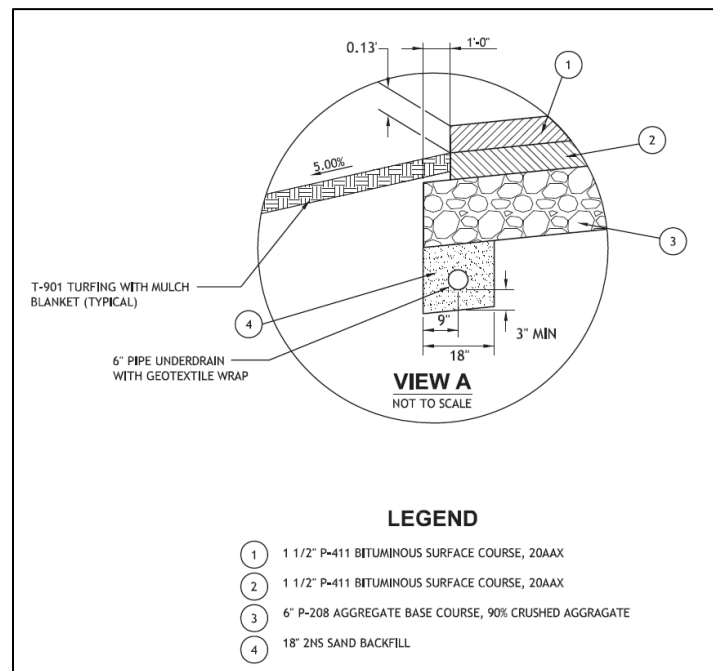

Figure A-38. Details of Typical Section Runway 17/35

Mix Design

Unavailable

Construction Report

Unavailable

Quality Control and Acceptance Results

Unavailable

Pavement performance data

Based on Pavement Management Reports provided by APTech, the most recent average PCI for Runway 17/35 was 80, rated in 2020. A plot of the average PCI ratings since the project was completed is shown in Figure A-39.

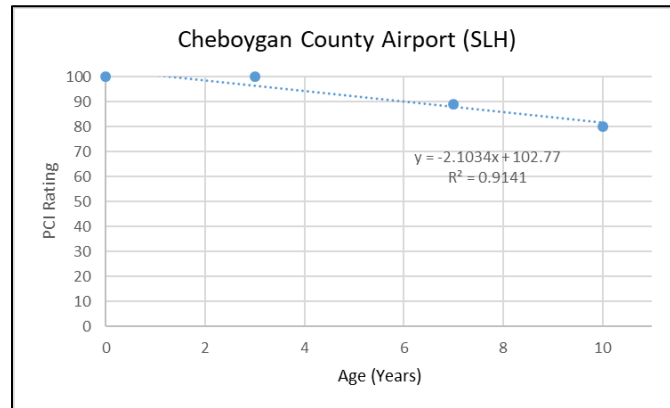

Figure A-39. Cheboygan County Airport Project Average PCI Ratings

The most prevalent types of distress throughout the runway include medium-severity swelling, low-severity alligator cracking, and low- and medium-severity L&T cracking. Of the distress deducts, 17% are related to load, 49% to climate, and 34% to other.

History of preventive or maintenance activities conducted on the airfield

There were no records of any preventative maintenance activities conducted on the project.

Aircraft load and traffic data

Based on the ADIP, the overall airport traffic operation per year is as follows:

- Air carrier: 0
- Air taxi: 0
- General aviation local: 3,427
- General aviation itinerant: 3,427
- Military: 0
- TOTAL OPERATIONS: 6,854

Based on the ADIP, Runway 06/24 is subjected to the following loads:

- Single wheel: 23,000 lb
- Dual wheel: 34,000 lb
- Two dual wheels in tandem: 60,000 lb

Houghton County Memorial Airport

Owner: Houghton County

Manager: Dennis M. Hext

Address: 23810 Airpark Boulevard, Suite 113, Calumet, MI 49913

Phone: 906-482-3970

Description of the Airport

Houghton County Memorial Airport (CMX) is a county-owned, public-use airport located 5 miles southwest of Calumet, in Houghton County, Michigan. The airport is situated on the Keweenaw Peninsula in the northwest part of the Upper Peninsula of Michigan. The airport covers an area of 1,996 acres at an elevation of 1,095 ft. It has two asphalt paved runways: 13/31 and 7/25 (see Figure A-40).

The report focuses on Runway 7/25.

Runway 07/25

- PCN: 18/F/C/X/U
- Dimensions: 5,201 ft x 100 ft
- Most recent rehabilitation: 2010
 - Reconstruction of Runway 7/25 and Runway Safety Areas (Michigan)
 - Project No. FM 31-6-C103; Federal Project No. 3-26-0041-3009

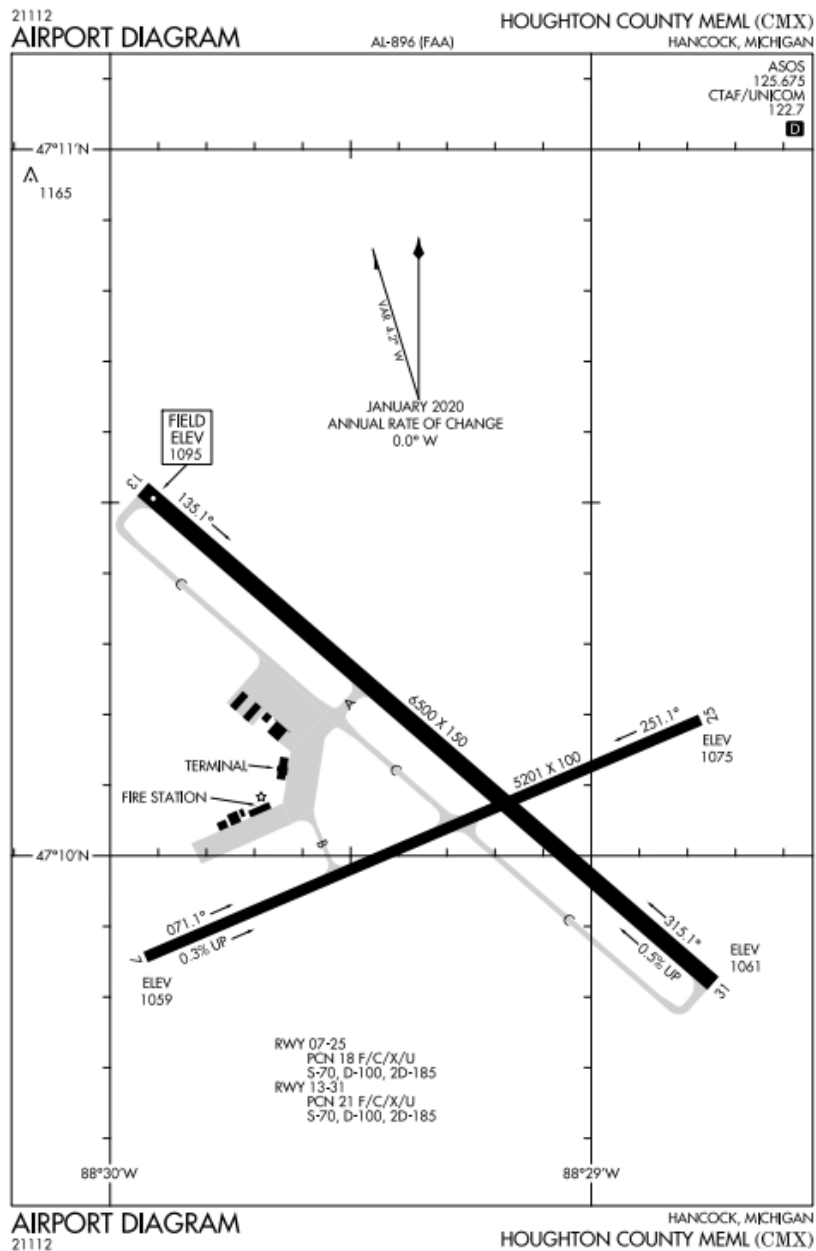

Figure A-40. Houghton County Memorial Airport

Plans and Specifications

The design consultant for the project was Peckham Engineering, Inc. The plans (as-builts) included a safety/phasing plan, typical sections, plan and profile sheets, drainage plans, soil erosion control plans, cross-sections, pavement marking plans, lighting, electrical, etc. Specifications were from the Michigan Department of Transportation Airports Division, Standard Specification P-411.

The reconstruction work on the project consisted of the placement of 17 in. of non-frost susceptible Type 3 subbase, 6-in. maximum size (Item No. 1547021); 24 in. of non-frost susceptible Type 2

subbase, 3-in. maximum size (Item No. 1547021) placed in two layers; 4 in. of non-frost susceptible Type 1 base, 1.5-in. maximum size (Item No. 2087021); 6 in. of bituminous aggregate base course (Item No. 4117031) placed in three 2-in. lifts; and 3 in. of bituminous surface course (Item No. 4110631) placed in two 1.5-in. lifts.

A summary of relevant quantities and pay items is shown in Table A-8.

Table A-8 Runway 07/25 Bid Quantities

Item No.	Description	Unit	Bid Quantity	Final Quantity
1547021	Non-Frost Susceptible Subbase Course, Type 3, Compacted Measure	C. Yd.	25,725	25,565
1547021	Non-Frost Susceptible Subbase Course, Type 2, Compacted Measure	C. Yd.	37,507	37,244
2087021	Non-Frost Susceptible Base, Type 1, Compacted Measure	C. Yd.	6,476	7,338
4117031	Misc. Bituminous Aggregate Base Course	Tons	21,025	18,930
4110631	Bituminous Aggregate Surface Course	Tons	10,615	12,735

The typical section for the main portion of Runway 07/25 and associated legend can be found in Figures A-41 and A-42.

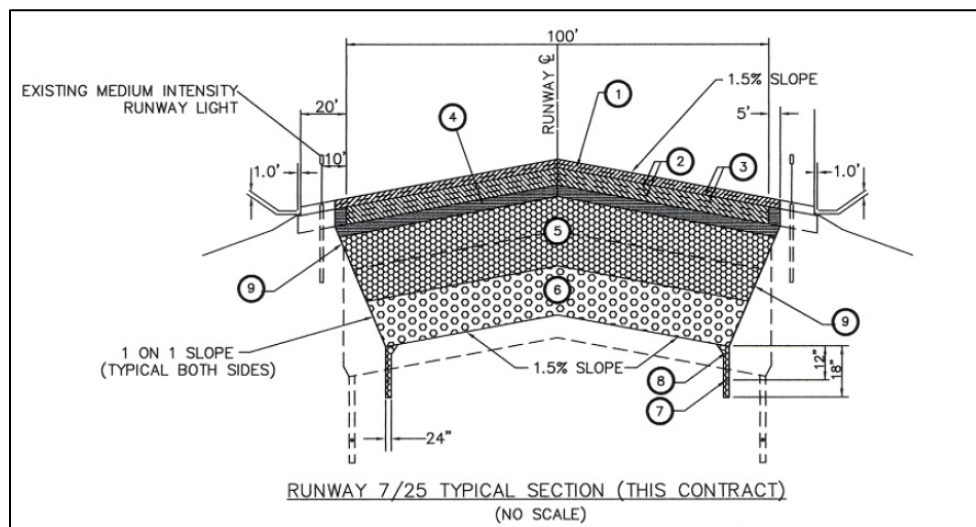

Figure A-41. Runway 07/25 Typical Section

- ① ITEM NO. 4110631: BITUMINOUS AGGREGATE SURFACE COURSE, 20AAA COMPOSITION, SPECIFICATION P-411, PG 58-28 ASPHALT BINDER, PLACED IN TWO, ONE AND ONE HALF (1.5") INCH COURSES. COMPACTED IN PLACE. COMPACTION SHALL BE DETERMINED ON THE BASIS OF PERCENT AIR VOIDS, IN THE COMPLETED COURSE.
- ② ITEM NO. 4117031: MISC. BITUMINOUS AGGREGATE BASE COURSE, 20AAA COMPOSITION WITH RECYCLE, SPECIFICATION P-411, PG 58-28 ASPHALT BINDER, CONFORMING TO THE DESIGN FOR AIRCRAFT GROSS WEIGHTS OF 60,000 LBS OR MORE (TABLE II) PLACED IN THREE 2-INCH COURSES, COMPACTED IN PLACE. THE BINDER GRADE SELECTION FOR USE IN THE RECYCLED MIXTURE SHALL BE DIVIDED INTO TWO CATEGORIES BY PERCENTAGE OF THE CONTRIBUTION OF RECLAIMED ASPHALT PAVEMENT (RAP) BINDER TO THE TOTAL BINDER, BY WEIGHT, IN THE MIXTURE: CATEGORY ONE (0-15% RAP BINDER BY WEIGHT OF THE TOTAL BINDER IN THE MIXTURE): NO BINDER GRADE ADJUSTMENT IS MADE TO COMPENSATE FOR THE STIFFNESS OF THE ASPHALT BINDER IN THE RAP. CATEGORY TWO (15-30% RAP BINDER BY WEIGHT OF THE TOTAL BINDER IN THE MIXTURE): THE SELECTED BINDER GRADE FOR THE ASPHALT BINDER IS ONE GRADE LOWER FOR THE HIGH TEMPERATURE THAN THE BINDER GRADE REQUIRED FOR THE SPECIFIED PROJECT MIXTURE TYPE. (FOR EXAMPLE: ASPHALT BINDER PG 58-28 BECOMES PG 52-28 FOR CATEGORY TWO). THE MAXIMUM AMOUNT OF RAP BINDER BY WEIGHT OF THE TOTAL BINDER IN THE MIX SHALL NOT EXCEED 30 PERCENT UNLESS OTHERWISE APPROVED BY THE ENGINEER. COMPACTION SHALL BE DETERMINED ON THE BASIS OF PERCENT AIR VOIDS, IN THE COMPLETED COURSE.
- ③ ITEM NO. 6030515: BITUMINOUS TACK COAT, SPECIFIED EMULSIFIED ASPHALT, SS1h, ASTM 1557, APPLICATION RATE 0.10 GAL/SYD. BETWEEN EACH COURSE OF ASPHALT PAVEMENT.
- ④ ITEM NO. 2087021: MISC. NON FROST SUSCEPTIBLE BASE, TYPE 1, 1.5-INCH MAXIMUM SIZE, COMPACTED IN PLACE, PER CUBIC YARD. PLACED IN ONE FOUR (4) INCH THICK LAYER COMPACTED TO NOT LESS THAN 100 PERCENT DENSITY. SEE SPECIFICATION SHEET 5.
- ⑤ ITEM NO. 1547021: MISC. NON FROST SUSCEPTIBLE SUBBASE: TYPE 2, 3-INCH MAXIMUM SIZE, COMPACTED IN PLACE, PER CUBIC YARD, PLACED IN TWO TWELVE INCH THICK LAYERS, TOTAL THICKNESS 24-INCHES. FIRST LAYER COMPACTED TO 95 PERCENT DENSITY, SECOND LAYER COMPACTED TO 100 PERCENT DENSITY.
- ⑥ ITEM NO. 1547021: MISC. NON FROST SUSCEPTIBLE SUBBASE: TYPE 3, 6-INCH MAXIMUM SIZE, COMPACTED IN PLACE, PER CUBIC YARD, PLACED IN ONE SEVENTEEN INCH THICK LAYER, COMPACTED TO 95 PERCENT DENSITY.
- ⑦ ITEM NO. 7050511: 6-INCH PIPE UNDERDRAIN: PIPE SHALL BE PLASTIC PIPE AS SPECIFIED UNDER 2.12, SPEC. D-705, PIPE UNDERDRAINS FOR AIRPORTS, WITH PIPE WRAP.
- ⑧ ITEM NO. 7057021: MISC. POROUS BACKFILL , SHALL BE OPEN GRADED AGGREGATE (MDOT 34R) PLACED IN ONE 18-INCH LAYER, COMPACTED IN PLACE.
- ⑨ ITEM NO. 8007011: MISC. GEOTEXTILE SEPARATOR, AS SPECIFIED.

Figure A-42. Typical Section Legend

Mix Design

No mix design information was available.

Construction Report

No construction information was available.

Quality Control and Acceptance Results

No QC or acceptance data were available.

Pavement performance data

Based on Pavement Management Reports provided by APTech, the most recent average PCI for Runway 07/25 was 84, last rated in 2018. A plot of the PCI ratings since the project was completed is shown in Figure A-43.

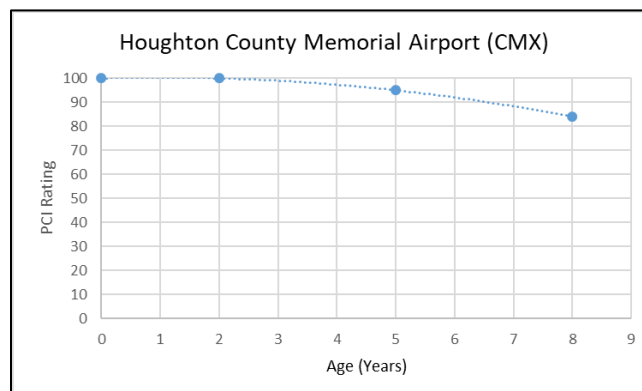

Figure A-43. Houghton County Airport Project Average PCI Ratings

Primary distresses include longitudinal and transverse cracking, raveling, and weathering (all low-severity). One hundred percent of the distress deducts are climate related.

History of preventive or maintenance activities conducted on the airfield

There were no records of any preventative maintenance activities conducted on the project.

Aircraft load and traffic data

Based on the ADIP, the overall airport traffic operation per year is as follows:

- Air carrier: 3,000
- Air taxi: 2,164
- General aviation local: 6,000
- General aviation itinerant: 4,870
- Military: 20
- TOTAL OPERATIONS: 16,054

Based on the ADIP, Runway 07/25 is subjected to the following loads:

- Single wheel: 70,000 lb
- Dual wheel: 100,000 lb
- Two dual wheels in tandem: 185,000 lb

Kirsch Municipal Airport)

Owner: City of Sturgis

Manager: Michael Hughes

Address: 130 N. Nottawa, Sturgis, MI 49091

Phone: 269-651-2321

Description of the Airport:

Kirsch Municipal Airport (IRS) is a publicly owned, public-use airport in Sturgis, Michigan. The airport is in the southern portion of Michigan, roughly 5 miles north of the Indiana border. The airport covers an area of 148 acres at an elevation of 925 ft. It has two paved runways: 06/24 (3,601 ft x 75 ft) and 18/36 (5,201 ft x 100 ft) (see Figure A-44).

This report focuses on Runway 06/24.

Runway 06/24

- PCN: NA
- Dimensions: 5,201 ft x 100 ft
- Most recent rehabilitation: 2013
- Rehabilitate and Mark Runway 6/24 (3,601 ft x 75 ft) and Taxiway C (1,246 ft x 35 ft)
- Project No. FM 78-1-C28

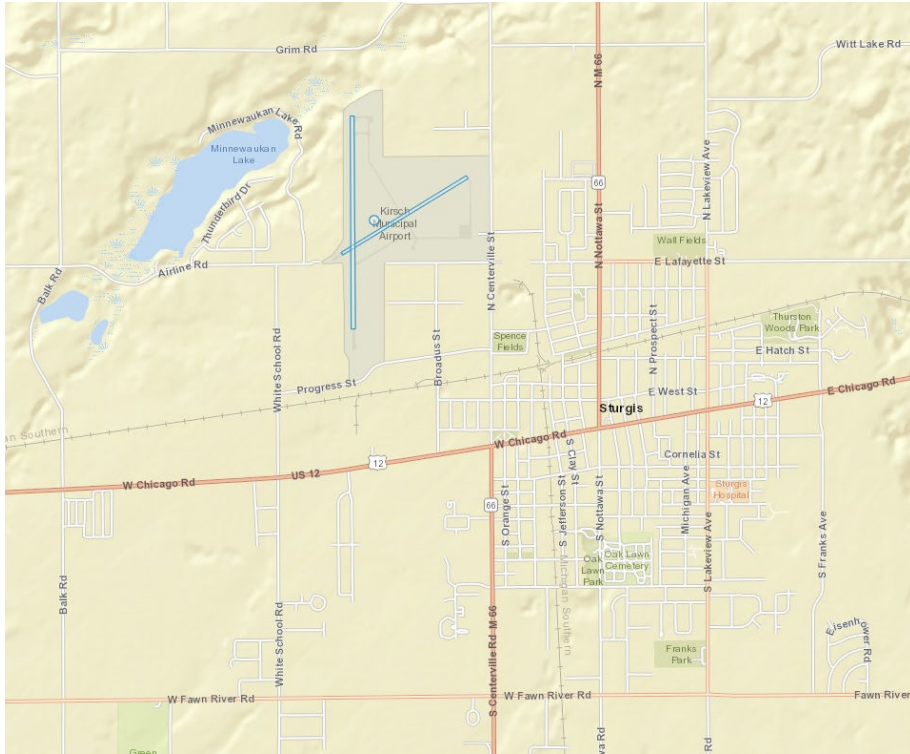

Figure A-44. Kirsch Municipal Airport

Plans and Specifications

The design consultant for the project was QOE Consulting of Lansing, Michigan. The limited plans that were available included the typical sections for Runway 6/24 and Taxiway C, pavement pulverizing plans, and the grading and paving plans for both the runway and taxiway. Specifications were from the Michigan Department of Transportation Airports Division, Standard Specification P-411.

The rehabilitation work on the project consisted of 9 in. to 12 in. of pulverized bituminous/ P-208 aggregate base, 1.5 in. of bituminous leveling course (P-411), and 1.5 in. of bituminous surface course (P-411). Note: The pulverized bituminous layer is likely referring to full depth reclamation, which is covered under P-207.

The typical section for the main portion of Runway 06/24 and associated legend can be found in Figures A-45 and A-46.

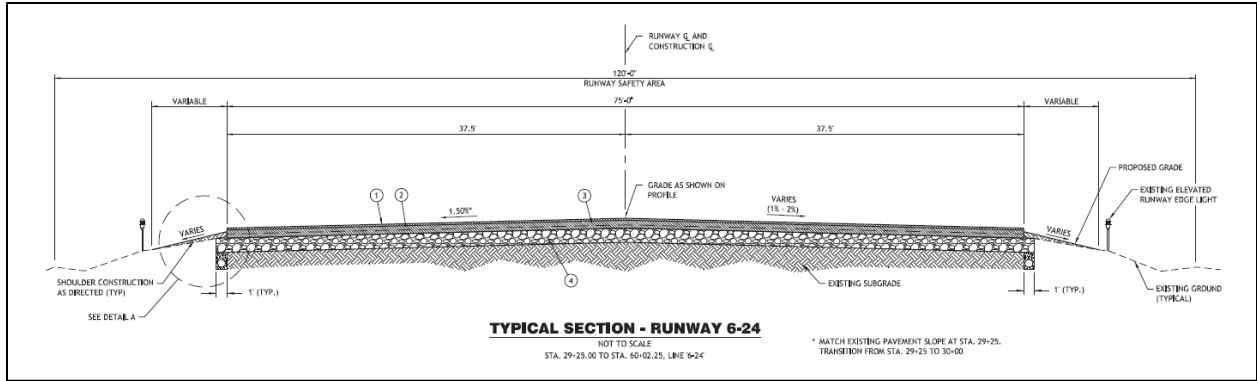

Figure A-45. Runway 06/24 Typical Section

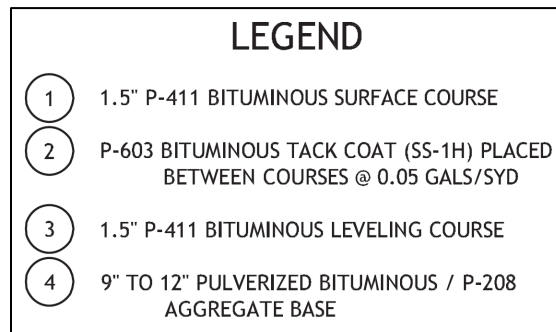

Figure A-46. Typical Section Legend

Mix Design

No mix design information was available.

Construction Report

No construction information was available.

Quality Control and Acceptance Results

No QC or acceptance data were available.

Pavement Performance Data

Based on Pavement Management Reports provided by APTEch, the most recent average PCI for Runway 06/24 was 84, last rated in 2018. A plot of the PCI ratings since the project was completed is shown in Figure A-47.

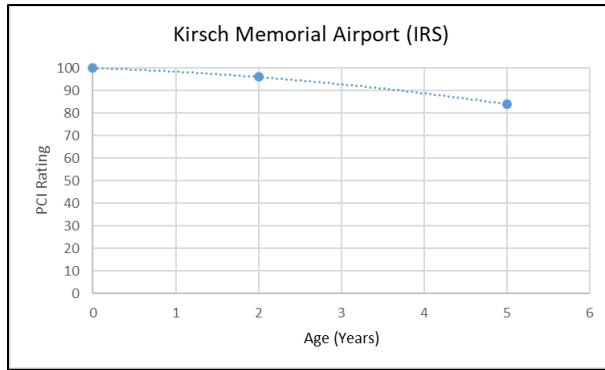

Figure A-47. PCI Ratings

Primary distresses include L&T cracking, raveling, and weathering, all low severity. The distribution of the distress deducts is 100% climate related.

History of preventive or maintenance activities conducted on the airfield

There were no records of any preventative maintenance activities conducted on the project.

Aircraft load and traffic data

Based on the ADIP, the overall airport traffic operation per year is as follows:

- Air carrier: 0
- Air taxi: 0
- General aviation local: 2,000
- General aviation itinerant: 6,000
- Military: 0
- TOTAL OPERATIONS: 8,000

Based on the ADIP, Runway 06/24 is subjected to the following loads:

- Single wheel: 19,000 lb
- Dual wheel: 25,000 lb
- Two dual wheels in tandem: 58,000 lb

Marlette Township Airport (77G)

Owner: Marlette Township
 Manager: Phil Roach
 Address: 6725 Airport Road, Marlette, MI 48453
 Phone: 810-459-4674

Description of the Airport:

Marlette Township Airport is a publicly owned, general aviation airport located in Marlette Township, Michigan. The airport is located approximately 60 miles north of Detroit. It has an FAA service level of general aviation. The airport covers an area of 480 acres at an elevation of 895 ft. It has two paved runways: 01/19 (3,500 ft x 75 ft) and 09/27 (3,795 ft x 75 ft) (see Figure A-48).

This report focuses on Runway 01/19.

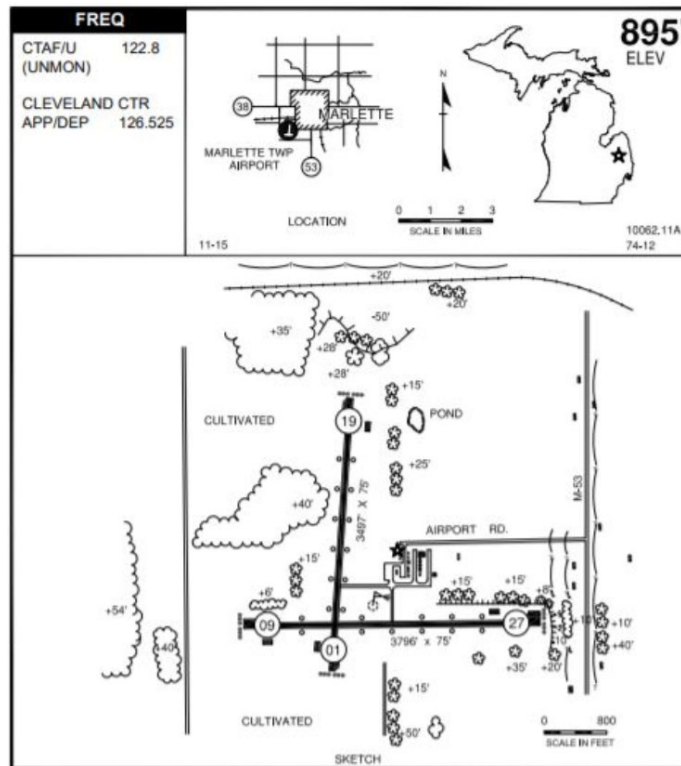

Figure A-48. Marlette Township Airport

Runway 01/19

- PCN: NA
- Dimensions: 3,500 ft x 75 ft
- Most recent rehabilitation: 2015
 - Runway 1/19 rehabilitation
 - Federal Project No. F-26-0062-1811
 - State Contract No. FM-74-12-C23

Plans and Specifications

The design consultant for the project was C&S Engineers, Inc. of Livonia, Michigan. The plans included a summary of contract quantities, supplemental specifications, construction safety/phasing plans, grading plans, profiles, typical sections and pavement repair details, drainage

and soil erosion details, and lighting and electrical plan for the runway. Specifications were from the Michigan Department of Transportation Airports Division, Standard Specification P-411.

The Airport Pavement Design Data shown in the plans indicate the runway was designed for Aircraft Design Group and Aircraft Approach Category IIIB, with an aircraft gross weight of under 12,500 lb and a tire pressure under 100 psi.

The rehabilitation work on the project consisted of milling 3 in. followed by the placement of two layers of bituminous surface course (P-411), each at a thickness of 1.5 in.

The typical section for the main portion of Runway 01/19 can be found in Figure A-49.

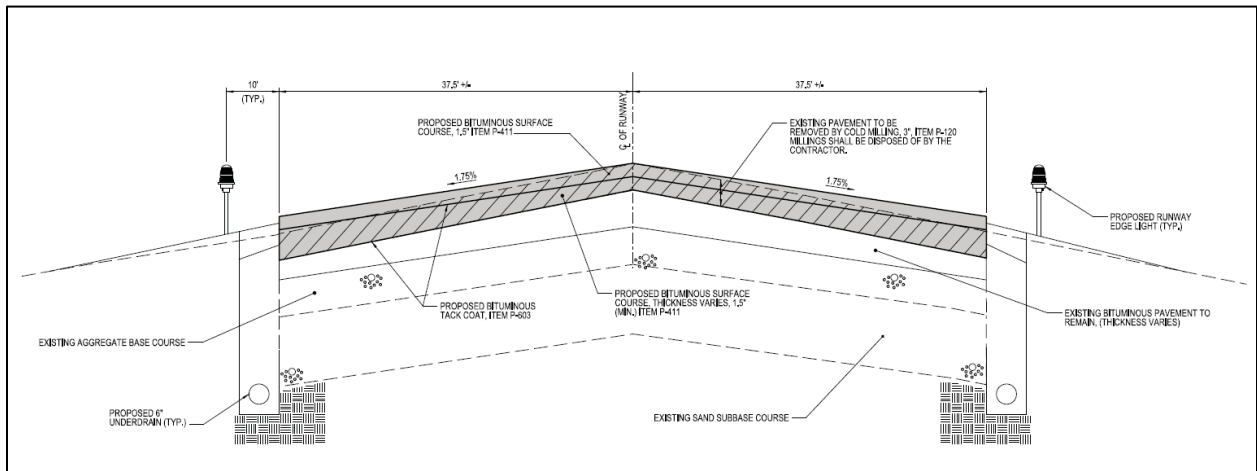

Figure A-49. Runway 06/24 Typical Section

A summary of relevant pay items is shown in Table A-9.

Table A-9. Runway 06/24 Bid Quantities

Item Number	Description	Units	Quantity
4000531	Cold Mill Bituminous Pavement	SY	36,000
4110620	3" Bituminous Aggregate Surface Course	Tons	7,900

Mix Design

The plans indicate that a 20AAX mix design was used. No additional mix design information was available.

Construction Report

No construction information was available.

Quality Control and Acceptance Results

No QC or acceptance data were available.

Pavement Performance Data

Based on Pavement Management Reports provided by APTEch, the most recent average PCI for Runway 01/19 was 89, last rated in 2020. A plot of the PCI ratings since the project was completed is shown in Figure A-50.

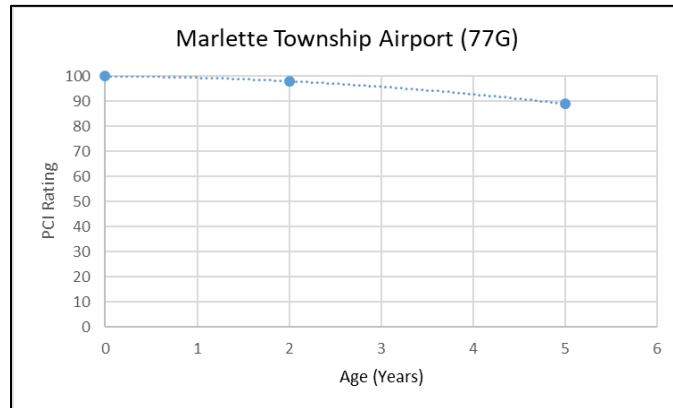

Figure A-50. Marlette Township Airport Project Average PCI Ratings

Primary distresses include low-severity L&T cracking and weathering. One hundred percent of the distress deducts are climate related.

History of preventive or maintenance activities conducted on the airfield

There were no records of any preventative maintenance activities conducted on the project.

Aircraft load and traffic data

Based on the ADIP, the overall airport traffic operation per year is as follows:

- Air carrier: 0
- Air taxi: 0
- General aviation local: 5,000
- General aviation itinerant: 5,000
- Military: 0
- Total Operations: 10,000

Oakland County International Airport (PTK)

Owner: County of Oakland

Manager: Cheryl Bush

Address: 1200 N. Telegraph Road, Pontiac, MI 48341

Phone: 248-666-3900

Description of the Airport

Oakland County International Airport is a county-owned, public-use airport located in Waterford Township, Oakland County, Michigan. It is approximately 30 miles northwest of Detroit, and 30 miles due north of the Detroit Metropolitan Wayne County Airport. The airport has an FAA service level classification as Reliever.

The airport covers 750 acres and sits at an elevation of 981 ft. The airport has three runways as shown in Figure A-51: 09L/27 (5,676 ft x 100 ft), 09R/27L (6,521 ft x 150 ft), and 18/36 (2,582 ft x 75 ft). Runway 18/36 is the focus of this report.

Runway 18/36

- PCN: 2/F/A/X/U
- Dimensions: 2,582 ft x 75 ft
- Most recent rehabilitation date: 2006

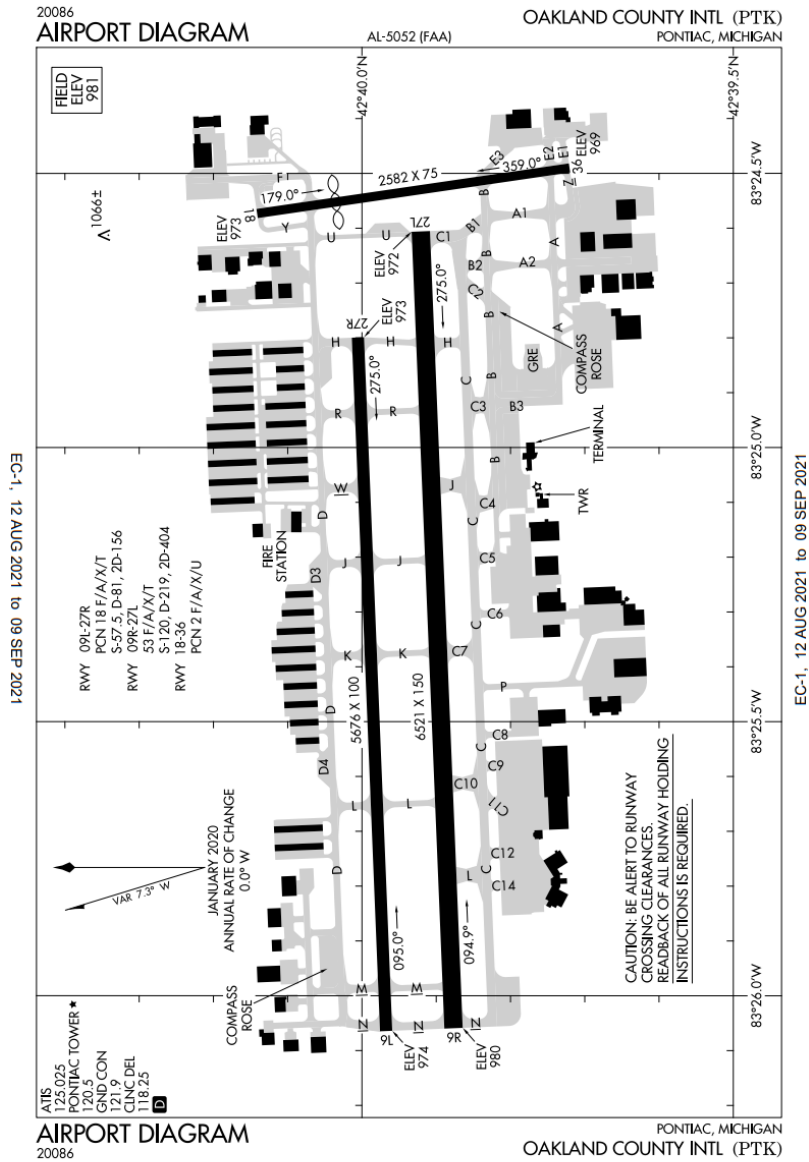

Figure A-51. Oakland County International Airport

Plans and Specifications

Plans for the project were not available. Specifications were from the Michigan Department of Transportation Airports Division, Standard Specification P-411.

Mix Design

The mix designs for the project were not available.

Construction Report

Construction reports were not available.

Quality Control and Acceptance Results

QC and acceptance data were not available for the project.

Pavement performance data

Based on Pavement Management Reports provided by APTEch, the most recent average PCI for Runway 18/36 was 65, rated in 2020. A plot of the average PCI ratings since the project was completed is shown in Figure A-52.

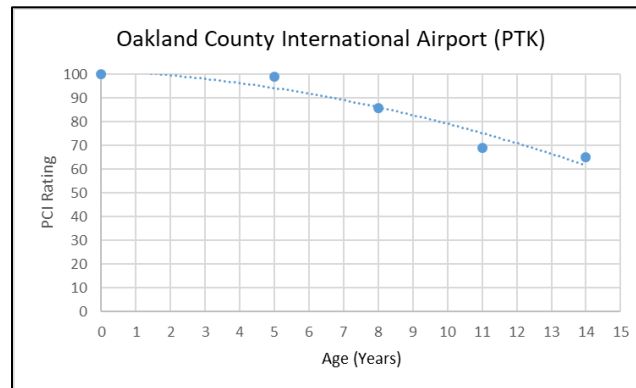

Figure A-52 PCI Rating

The most prevalent types of distress throughout the runway include high-, medium-, and low-severity longitudinal and transverse cracking, and medium-severity weathering. Of the distress deducts, 100% are related to climate.

History of preventive or maintenance activities conducted on the airfield

There were no records of any preventative maintenance activities conducted on the project.

Aircraft load and traffic data

Based on the ADIP, the overall airport traffic operations per year is as follows:

- Air carrier: 247
- Air taxi: 9,075
- General aviation local: 66,271
- General aviation itinerant: 47,435
- Military: 304
- TOTAL OPERATIONS: 123,332

No maximum aircraft gross weights were shown on the ADIP.

St. Clair County International Airport (PHN)

Owner: Saint Clair County

Manager: Kathy Reaume

Address: 201 McMorrان Boulevard, Port Huron, MI 48060

Phone: 810-364-6890

Description of the Airport

St. Clair County International Airport is a public airport owned by the government of St. Clair County, Michigan. It is in Kimball Township, 5 miles southwest of the central business district of Port Huron, MI. The airport has an FAA service level classification of Reliever.

The airport covers 1,135 acres and sits at an elevation of 650 ft. The airport has two runways (see Figure A-53): 04/22 (5,104 ft x 100 ft) and 10/28 (4,000 ft x 75 ft). Runway 10/28 is the focus of this report.

Runway 10/28

- PCN: NA
- Dimensions: 4,000 ft x 75 ft
- Most recent rehabilitation date: 2005

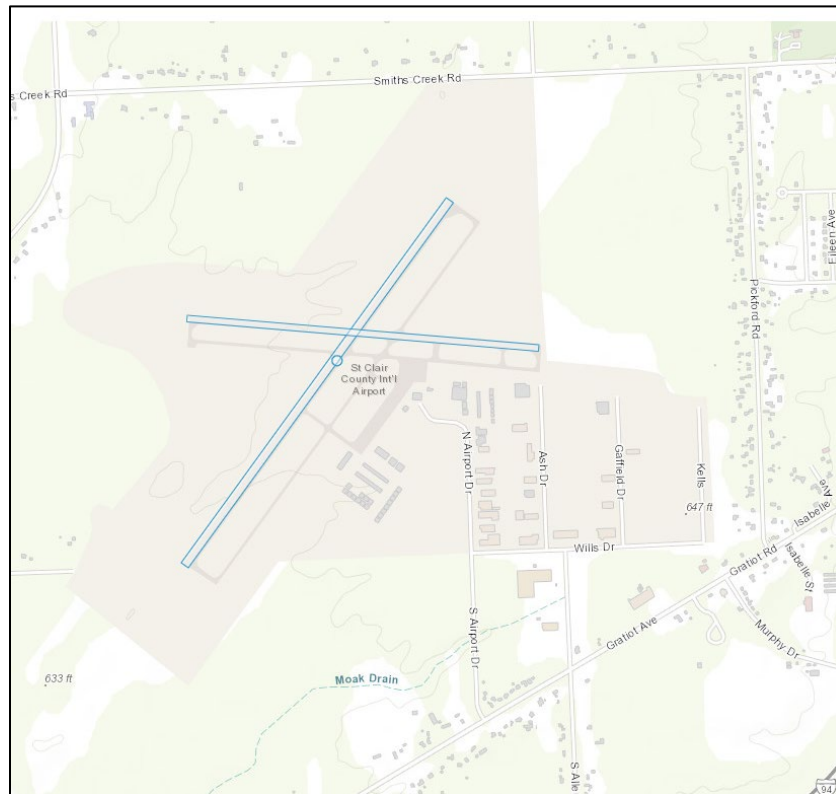

Figure A-53. St. Clair County International Airport

Plans and Specifications

Plans for the project were not available. This project used FAA P-401 specifications.

Mix Design

The mix designs for the project were not available.

Construction Report

Construction reports were not available.

Quality Control and Acceptance Results

QC and acceptance data were not available for the project.

Pavement performance data

Based on Pavement Management Reports provided by APTEch, the most recent average PCI for Runway 10/28 was 60, rated in 2018. A plot of the average PCI ratings since the project was completed is shown in Figure A-54.

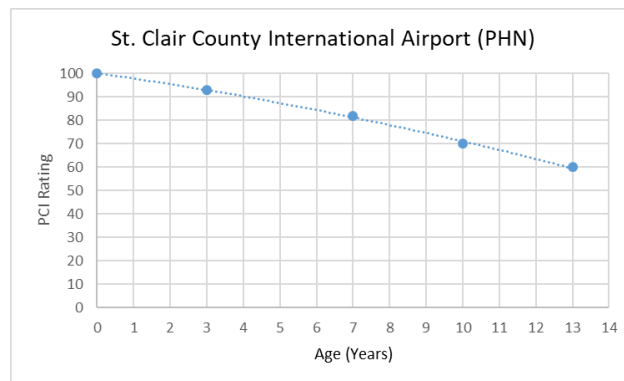

Figure A-54 PCI Rating

The primary distresses consisted of medium-severity longitudinal and transverse cracking, and low- and medium-severity weathering. There were also more than 12,000 square ft of patching on the runway. One hundred percent of the distress deducts were related to climate.

History of preventive or maintenance activities conducted on the airfield

There were no records of any preventative maintenance activities conducted on the project.

Aircraft load and traffic data

Based on the ADIP, the overall airport traffic operation per year is as follows:

- Air carrier: 0
- Air taxi: 0
- General aviation local: 7,000
- General aviation itinerant: 20,000

- Military: 500
- TOTAL OPERATIONS: 27,500

Based on the ADIP, Runway 07/25 is subjected to the following loads:

- Single wheel: 40,000 lb
- Dual wheel: 55,000 lb
- Two dual wheels in tandem: 90,000 lb

Wisconsin

Amery Municipal Airport

Owner: City of Amery

Manager: Ay Griggs

Address: 118 Center Street, Amery, WI 54001

Phone: 715-268-7486

Description of the Airport

Amery Municipal Airport (AAH) is a city-owned, public-use airport located 2 nautical miles south of the central business district of Amery, a city in Polk County, Wisconsin. It is included in the FAA National Plan of Integrated Airport Systems for 2021–2025, where it is categorized as a local general aviation facility.

The airport covers 218 acres and sits at an elevation of 1,088 ft. The airport has one runway (see Figure A-55): 18/36 (4,000 ft x 75 ft).

Runway 18/36

- PCN: NA
- Dimensions: 4,000 ft x 75 ft
- Most recent rehabilitation date: 2015

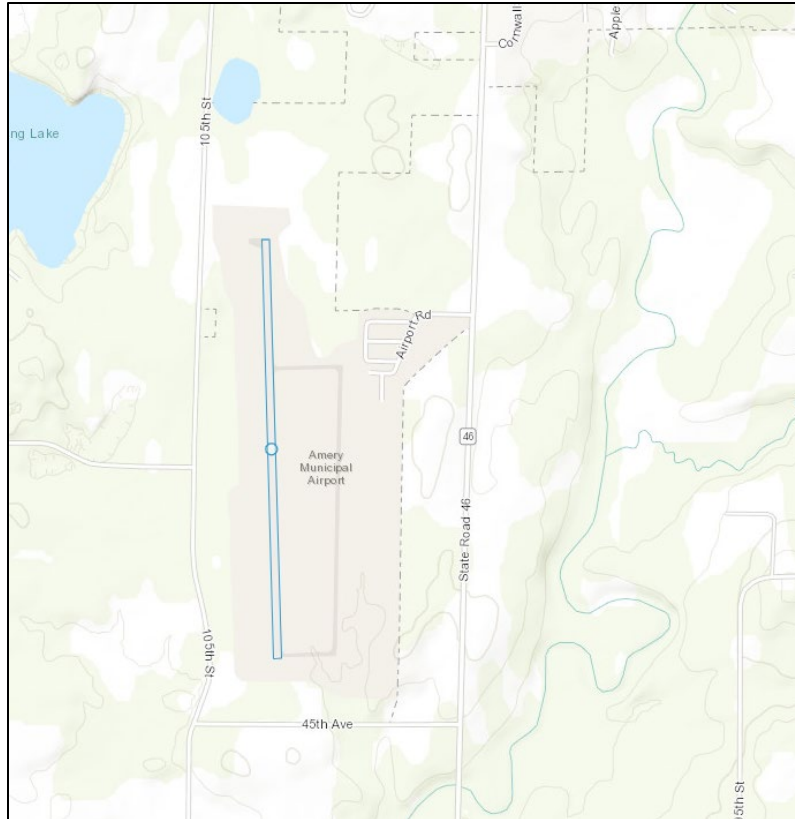

Figure A-55. Amery Municipal Airport

Plans and Specifications

Plans for the project were not available. The project used FAA specifications.

Mix Design

The mix designs for the project were not available.

Construction Report

Construction reports were not available.

Quality Control and Acceptance Results

QC and acceptance data were not available for the project.

Pavement performance data

Based on Pavement Management Reports provided by APTEch, Runway 18/36 was divided into two segments. The most recent average PCI for the two segments was 80 (individual ratings were 77 and 83) rated in 2020. A plot of the average PCI ratings since the project was completed is shown in Figure A-56.

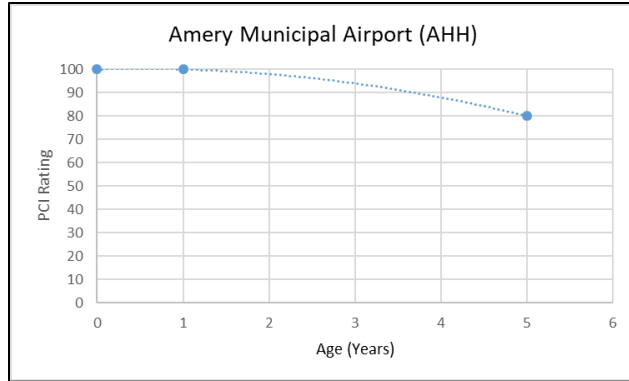

Figure A-56. PCI Rating

Primary distresses include low- and medium-severity L&T cracking. One hundred percent of the distress deducts are climate related.

History of preventive or maintenance activities conducted on the airfield

There were no records of any preventative maintenance activities conducted on the project.

Aircraft load and traffic data

Based on the ADIP, the overall airport traffic operation per year is as follows:

- Air Carrier: 0
- Air Taxi: 200
- General Aviation Local: 7,000
- General Aviation Itinerant: 6,600
- Military: 100
- TOTAL OPERATIONS: 13,900

Based on the ADIP, Runway 18/36 is subjected to the following maximum aircraft gross weights:

- Single Wheel: 12,500 lb

Prairie du Chien Municipal Airport

Owner: City of Prairie du Chien
 Address: P.O. Box 324, Prairie du Chien, WI 53821
 Phone: 608-326-6406

Manager: Chad Abram
 Address: 214 East Blackhawk, P.O. Box 324, Prairie du Chien, WI 53821
 Phone: 608-326-6406

Description of the Airport

Prairie du Chien (PDC) is a city-owned, public-use airport located 2 miles southwest of Prairie du Chien, a city in Crawford County, Wisconsin. It is included in the FAA National Plan of Integrated Airport Systems for 2019–2023, where it is categorized as a basic general aviation facility. The airport covers 257 acres and it is located at an elevation of 661 ft. The airport has two runways: 11/29 (3,999 ft x 75 ft) and 14/32 (5,000 ft x 75 ft) (see Figure A-57). This report focuses on Runway 11/29.

Reconstruct Runway 11/29

Reconstruction date: 2012

Project Number AIP 3-55-0067-09

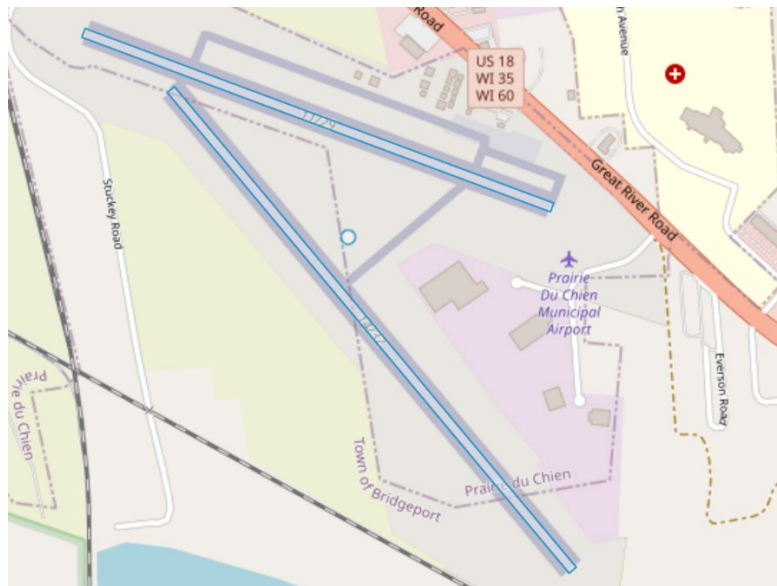

Figure A-57. Prairie du Chien Municipal Airport (open street map)

Plans

Construction plans (as-built) and specifications were provided by the Wisconsin Department of Transportation, Division of Aeronautics. The design consultant for the project was Omni Associates, from Appleton, Wisconsin. The scope of the project was the construction of a new Runway 11/29.

The plans included a site plan, summary of quantities, construction and safety plan, existing conditions, typical sections and pavement details, plan and profile sheets, drainage plans, cross-sections, pavement marking plans, lighting, electrical, etc.

This rehabilitation consisted of the removal of the existing runway pavements, followed by the placement of a 6-in. pulverized asphalt pavement and base; 3-in. hot-mix asphalt (HMA) pavement; type E-3 in two layers, upper lift 1 1/2 in. of a 12.5-mm NMA mix with PG 64-28P;

lower lift 1 1/2 in. of a 12.5-mm NMAS with PG 58-28. The typical section for the Apron is shown in Figure A-58.

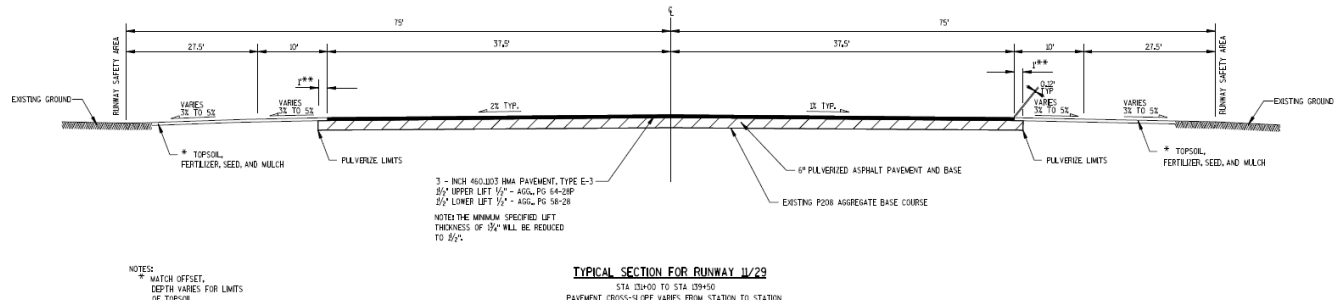

Figure A-58. Typical Section for Runway 11/29

Specifications

The specifications for the project related to HMA pavement were the Standard Specifications for Highway and Structure Construction, 2011 edition; Item 460 “Hot Mix Asphalt Pavement.”

Mix Design

Mathy Construction designed the HMA lower and upper lifts. They consisted of a 12.5-mm NMAS mix, E-3 (traffic between 1–3 equivalent single-axle loads [ESALs] $\times 10^6$), N_{design} of 75 gyrations. The optimum binder content was 5.9%, and the mixtures contained 15% RAP. The design air voids were 4.0% with a corresponding VMA of 15%. The binder grade was a PG 64-28P (Midwest Fuels-LaCrosse) for the upper layer and a PG 58-28 (Midwest Fuels-LaCrosse) for the lower layer with the same design.

Construction Report

A total of 6,935 tons of asphalt was placed from July 6 to July 11, 2012. On Runway 11/29, a total of 3,382 tons of asphalt was placed as binder mat, and 267.67 tons were placed as binder mat on the Taxiway C and C2 expansion areas. On Runway 11/29, a total of 2,975 tons was placed as surface mat and 311 tons were placed as surface mat on the Taxiway C and C2 expansion areas. The binder mat was placed in 2 days and surface mat in 3 days.

Quality Control and Acceptance Results

The asphalt was tested according to the State of Wisconsin Department of Transportation Standard Specifications for Highway and Structure Construction. The lot size for density acceptance was 750 tons. Each lot met the requirements for density and air voids. Control charts were developed for QC of the mix during production. These control charts indicate the quality of the mix was within specification limits for air voids, gradation, and asphaltic content.

Pavement performance data

Based on Pavement Management Reports provided by APTEch for pavement condition conducted in 2020:

- Runway section 10 had a PCI rating of 73. The primary distresses included low- and medium-severity longitudinal and transverse cracking, alligator cracking, and weathering. Seventy-seven percent of the distress deducts were related to climate, and 23% were related to load.
- Runway section 20 had a PCI rating of 78. The primary distresses included low- and medium-severity longitudinal and transverse cracking, and weathering. One hundred percent of the distress deducts were related to climate.

History of preventive or maintenance activities conducted on the airfield

There were no records of preventative maintenance activities conducted on the project.

Aircraft load and traffic data

Based on the ADIP, the overall airport traffic operation per year is as follows:

- Air carrier: 0
- Air taxi: 500
- General aviation local: 7,200
- General aviation itinerant: 4,550
- Military: 50
- TOTAL OPERATIONS: 12,300

Based on the ADIP, Runway 11/29 is subjected to the following loads:

- Single wheel: 24,000 lb
- Dual wheel: 40,000 lb

Fort Atkinson Municipal Airport

Owner: City of Fort Atkinson
Manager: Andy Selle
101 North Main Street
Fort Atkinson, WI 53538
920-563-7760

Description of the Airport

Fort Atkinson Municipal Airport (61C) is a city-owned, public-use airport located 3 miles northeast of Fort Atkinson, a city in Jefferson County, Wisconsin. It is included in the FAA National Plan of Integrated Airport Systems for 2019–2023, where it is categorized as a local general aviation facility. The airport covers 118 acres and is located at an elevation of 800 ft. The airport has one runway, 03/21 (3,800 ft x 60 ft), as shown in Figure A-59. This report focuses on the reconstruction of Runway 03/21.

Reconstruct Runway 03/21

Reconstruction date: 2013

Project Number AIP 3-55-0004-08



Figure A-59. Fort Atkinson Municipal Airport (open street map)

Plans

Partial information was available related to plans. The design consultant for the project was MSA Professional Services of Madison, Wisconsin. The reconstruction work consisted of milling bituminous surface (thickness varied) and constructing a new bituminous surface in one lift, 2 in. 12.5 mm NMAAS mix with PG 64-28P. The typical section for Runway 03/21 is shown in Figure A-60.

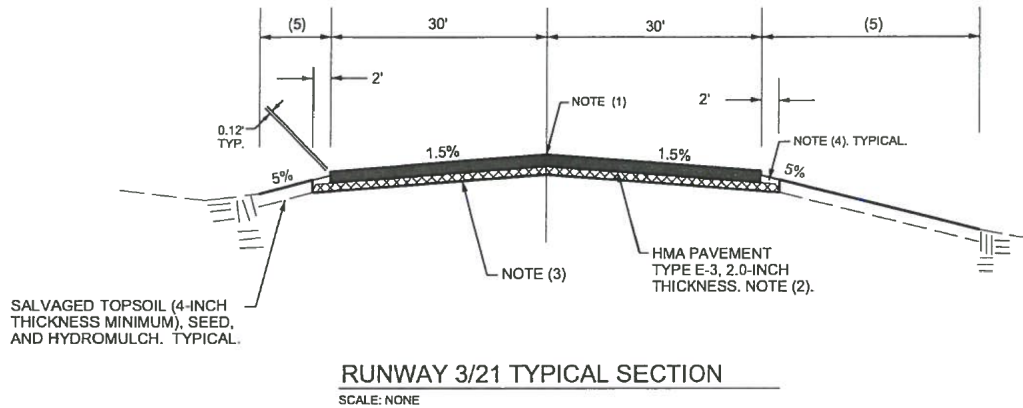

Figure A-60. Typical Section Runway 03/21

Specifications

The specifications for the project related to HMA pavement were the Standard Specifications for Highway and Structure Construction, 2011 edition; Item 460.1103 “Hot Mix Asphalt Pavement.”

Mix Design

Road Rock Companies designed the HMA lower and upper lifts. They consisted of 12.5 mm NMAS mixes, E-3 (traffic between 1 and 3 ESALs $\times 10^6$), N_{design} of 75 gyrations. The optimum binder content was 5.9%, and the mixtures contained 15% RAP. The design air voids were 4.0% with a corresponding VMA of 15%. The binder grade was a PG 64-28P (Midwest Fuels-LaCrosse) for upper layer, and a PG 58-28 (Midwest Fuels-LaCrosse) for the lower layer with the same design.

Construction Report

Construction reports were not available.

Quality Control and Acceptance Results

QC and acceptance data were not available for the project.

Pavement performance data

Pavement condition data are based on Pavement Management Reports provided by APTEch for 2020.

- Runway 03/21, section 10, had a PCI rating of 79. The primary distresses included low- and medium-severity longitudinal and transverse cracking, and weathering, and low-severity alligator cracking. Eighty-one percent of the distress deducts were related to climate, and 19% were related to load.
- Runway 03/21, section 20, had a PCI rating of 88. The primary distresses included low-severity longitudinal and transverse cracking, medium- and high-severity raveling, and

low-severity weathering. One hundred percent of the distress deducts were related to climate.

- Runway 03/21, section 30, had a PCI rating of 90. The primary distresses included low-severity longitudinal and transverse cracking, and low-severity weathering. One hundred percent of the distress deducts were related to climate.

History of preventive or maintenance activities conducted on the airfield

There were no records of preventative maintenance activities conducted on the project.

Aircraft load and traffic data

Based on the ADIP, the overall airport traffic operation per year is as follows:

- Air carrier: 0
- Air taxi: 200
- General aviation local: 7,350
- General aviation itinerant: 3,300
- Military: 50
- TOTAL OPERATIONS: 10,900

Based on the ADIP, Runway 03/21 is subjected to the following loads:

- Single wheel: 12,000 lb

Crandon Municipal Airport

Owner:

City of Crandon
601 W. Washington Street, P.O. Box 335
Crandon, WI 54520
715-478-2400

Manager:

Norman Knoll
8765 Mary Street
Argonne, WI 54511
715-649-3225

Description of the Airport

Crandon Municipal Airport (Y55) is a city-owned, public-use airport located 3 miles southwest of Crandon, a city in Forest County, Wisconsin. It is included in the FAA National Plan of Integrated Airport Systems for 2021–2025, where it is categorized as a basic general aviation facility. The airport covers 259 acres and is located at an elevation of 1,650 ft. The airport has two runways: 11/29 (3,550 ft x 75 ft), and 1/19 (2,742 ft x 100 ft), as shown in Figure A-61. This report focuses on Runway 11/29.

Reconstruct Runway 11/29

Reconstruction date: 2012

Project Number AIP 3-55-0004-08

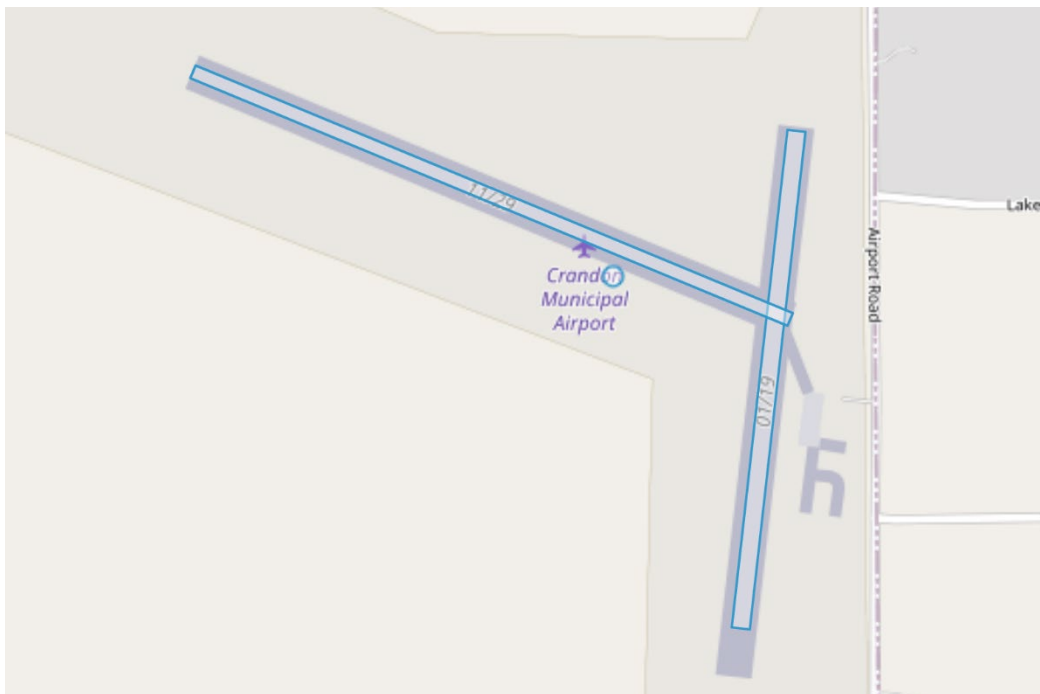

Figure A-61. Crandon Municipal Airport (open street map)

Plans

Partial information was available related to plans. The design consultant for the project was MSA Professional Services of Madison, Wisconsin. The reconstruction work was as follows: Reconstruction of Runway 11/29 included full pulverization to a depth of 10 in. New pavement included bituminous surface type E-3 in two lifts, 2 in. binder course (19mm NMAS), with PG 58-28, and a 1.5-in. surface course (12.5mm NMAS) with PG 64-28. The typical section for the 11/29 is shown in Figure A-62.

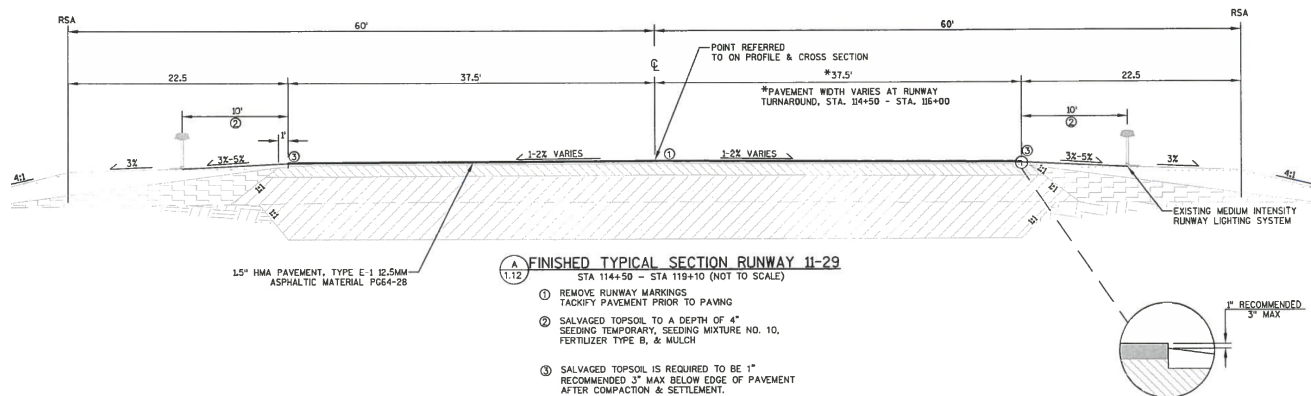

Figure A-62. Typical Section Runway 11/29

Specifications

The specifications for the project related to HMA pavement were the *Standard Specifications for Highway and Structure Construction*, 2011 edition; Item 460—Hot Mix Asphalt Pavement.

Mix Design

The mix designs for the project were not available.

Construction Report

Construction reports were not available.

Quality Control and Acceptance Results

The minimum required average lot density for Type E-3 binder course constructed directly on recycled base course was 89.5%, and for the Type E-3 surface course was 91.5%. Each average lot density for both the lower and upper layers met minimum requirements. Sample test results indicate that both mixes met the acceptable verification parameters (V_a and VMA), as specified in 460.2.8.3.1.6.

Pavement performance data

Based on Pavement Management Reports provided by APTech for pavement condition conducted in 2018:

- Runway 11/29 had a PCI rating of 69. The primary distresses included low- and medium-severity longitudinal and transverse cracking, and medium- and high-severity weathering. One hundred percent of the distress deducts were related to climate.

History of preventive or maintenance activities conducted on the airfield

There were no records of preventative maintenance activities conducted on the project.

Aircraft load and traffic data

Based on the ADIP, the overall airport traffic operation per year is as follows:

- Air carrier: 0
- Air taxi: 200
- General aviation local: 7,350
- General aviation itinerant: 3,300
- Military: 50
- TOTAL OPERATIONS: 10,900

Based on the ADIP, Runway 11/29 is subjected to the following loads:

Single Wheel: 12,000 lb

Clintonville Municipal Airport

Owner:

City of Clintonville

Address: City Hall; 50 Tenth Street, Clintonville, WI 54929

Phone: 715-823-7600

Manager:

Caz Muske

Address: City Hall, 50 Tenth Street, Clintonville, WI 54929

Phone: 715-250-0220

Description of the Airport

Clintonville Municipal Airport (CLI) is located 2 miles southeast of Clintonville in Waupaca County, Wisconsin. It is categorized as a local general aviation facility. The airport has three runways: 14/32 (4,599 ft x 75 ft); 04/22 (3,812 ft x 75 ft); and 09/27 (2,002 ft x 170 ft) (see Figure A-63). This report focuses on Runway 04/22.

Reconstruct 04/22 and Extension

Reconstruction date: 2014

Project Number AIP 3-55-0004-08

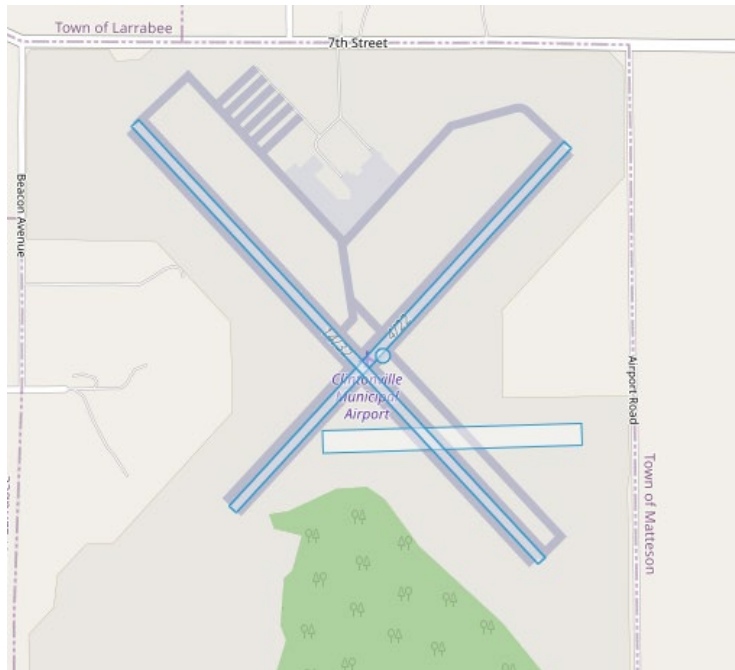

Figure A-63. Clintonville Municipal Airport (open street map)

Plans

Partial information was available related to plans. The design consultant for the project was OMNI Associates of Appleton, Wisconsin. The reconstruction work consisted of a new bituminous surface in two lifts: for lower layer, a 1.25-in. 19 mm NMAS with PG 58-28, and an upper layer with 1.75-in. 12.5 mm NMAS with PG 64-28P. The typical section for Runway 04/22 is shown in Figure A-64.

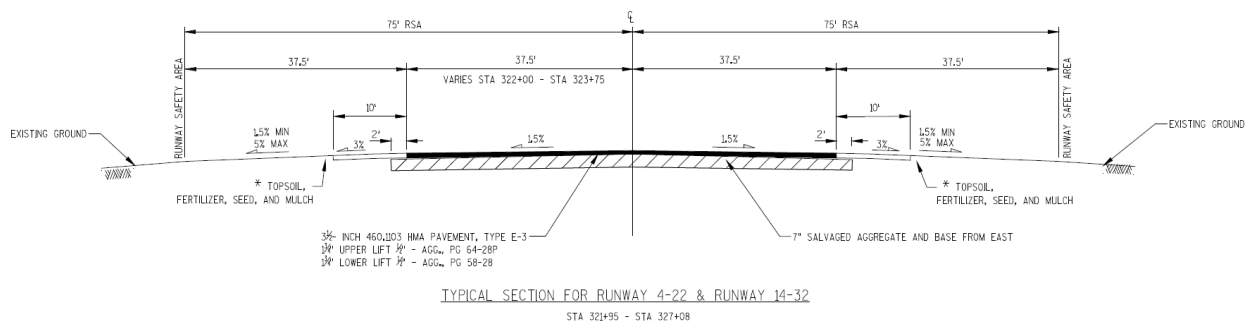

Figure A-64. Typical Section for Runway 04/22

Specifications

The specifications for the project related to HMA pavement were the Standard Specifications for Highway and Structure Construction, 2013 edition; Item 460 “Hot Mix Asphalt Pavement.”

Mix Design

The contractor, Northeast Asphalt, Inc. prepared the mix design.

Construction Report

Construction reports were not available.

Quality Control and Acceptance Results

Northeast Asphalt, Inc. placed HMA Pavement mix type E-3, 12.5mm NMAS on Runway 04/22 and approaching taxiways for a total of 7,633 tons. They used a PG 58-28 for the lower lift and PG 64-28P for surface. A report of volumetric mix design, verified by the Wisconsin DOT, was received and determined to meet project specifications. Northeast Asphalt performed the QC test and OMNNI Associates performed the quality verification test on the mix. Density was done at randomly selected locations by OMNNI Associates. All tests met project specifications.

Pavement performance data

Based on Pavement Management Reports provided by APTEch for pavement condition conducted in 2020:

- Runway 04/22 had a PCI rating of 84. The primary distresses included low- and medium-severity longitudinal and transverse cracking, and low weathering. One hundred percent of the distress deducts were related to climate.

History of preventive or maintenance activities conducted on the airfield

There were no records of preventative maintenance activities conducted on the project.

Aircraft load and traffic data

Based on the ADIP, the overall airport traffic operation per year is as follows:

- Air carrier: 0
- Air taxi: 750
- General aviation local: 5,000
- General aviation itinerant: 5,730
- Military: 20
- TOTAL OPERATIONS: 11,500

Based on the ADIP, Runway 04/22 is subjected to the following loads:

- Single wheel: 30,000 lb
- Dual wheel: 55,000 lb

Baraboo-Wisconsin Dells Regional

Owner: Airport Commission

Manager: Bill Murphy

Address: 101 South Boulevard, Baraboo, WI 53913

Phone: 608-355-2700

Description of the Airport

Baraboo-Wisconsin Dells Regional Airport (DLL) is a city-owned, public-use airport located 3 miles northwest of Baraboo in Sauk County, Wisconsin. It is included in the FAA National Plan of Integrated Airport Systems for 2019–2023, where it is categorized as a regional general aviation facility. The airport covers 312 acres and is located at an elevation of 979 ft. The airport has two runways: 1/19 (5,100 ft x 75 ft) and 14/32 (2,746 ft x 100 ft) (see Figure A-65). This report focuses on the apron.

Reconstruct Apron

Reconstruction date: 2011

AIP Project No. 3-55-0004-08

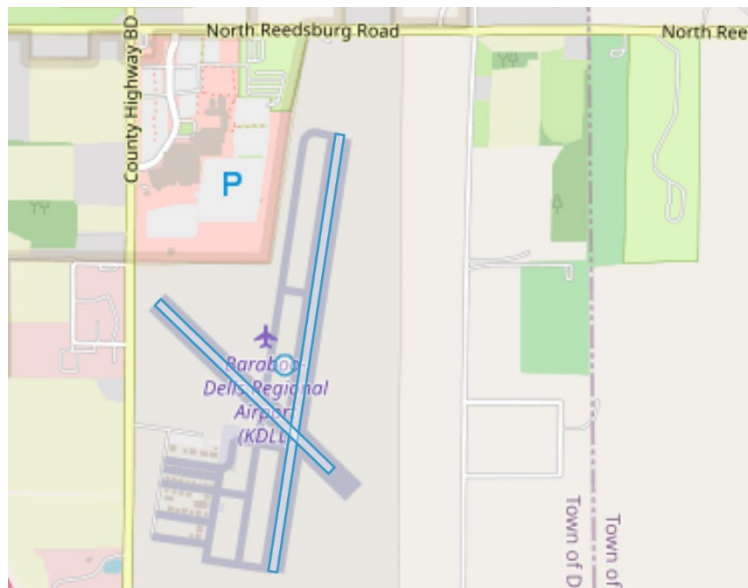

Figure A-65. Baraboo-Wisconsin Dells Regional (open street map)

Plans

Partial information related to plans was available. The design consultant for the project was MSA Professional Services of Madison, Wisconsin. The reconstruction work was as follows: apron consisted of milling bituminous surface (thickness varies) and construct new bituminous surface in two lifts, 2.25-in. binder course (19-mm NMA) with PG 58-28, and 1.75-in. surface course (12.5-mm NMA) with PG 64-28P. The typical section for the apron is shown in Figure A-66.

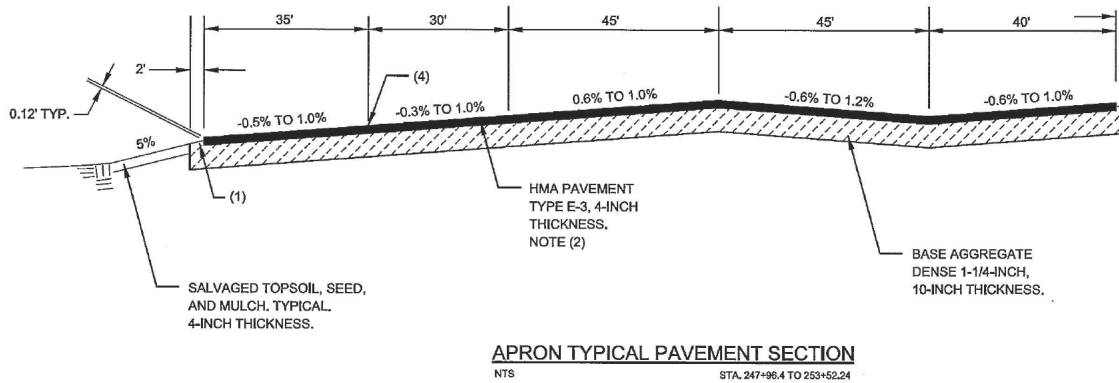

Figure A-66. Typical Section Apron

Specifications

This project used FAA specifications.

Mix Design

The mix designs for the project were not available.

Construction Report

Construction reports were not available.

Quality Control and Acceptance Results

QC and acceptance data were not available for the project.

Pavement performance data

Based on Pavement Management Reports provided by APTech for pavement condition conducted in 2018, the apron had a PCI rating of 73. The primary distresses included low- and medium-severity longitudinal and transverse cracking, and weathering. One hundred percent of the distress deducts were related to climate.

History of preventive or maintenance activities conducted on the airfield

There were no records of preventative maintenance activities conducted on the project.

Aircraft load and traffic data

Based on the ADIP, the overall airport traffic operation per year is as follows:

- Air carrier: 0
- Air taxi: 1,000
- General aviation local: 7,500

- General aviation itinerant: 19,000
- Military: 2,500
- TOTAL OPERATIONS: 30,000

Based on the ADIP, Runway 14/32 is subjected to the following load:

- Single wheel: 20,000 lb
- Dual wheel: 55,000 lb

Bloyer Field (Y72)

Owner: City of Tomah
 Manager: William Kobleska
 Address: City of Tomah, 819 Superior Avenue, Tomah, WI 54660
 Phone: 608-374-7440

Description of the Airport

Bloyer Field (Y72) is a city-owned, public-use airport located 1 mile east of Tomah, a city in Monroe County, Wisconsin. The airport provides general aviation services. The airport covers 160 acres and it is located at an elevation of 966 ft. The airport has one runway 7/25 (3,900 ft x 75 ft) (see Figure A-67). This reports focuses on the Apron and Taxiway A.

Reconstruct Apron and Taxiway A

Reconstruction date: 2014
 Project Number SAP 0741-40-55



Figure A-67. Bloyer Field (open street map)

Plans

Partial information related to plans was available. The design consultant for the project was MSA Professional Services of Madison, Wisconsin.

The reconstruction for the Apron and Taxiway B consisted of milling 2 in. to 4 in. of bituminous surface and regrading, compacting existing base course or new base as necessary, and constructing new bituminous surface in two lifts, 1.5 in each (12.5 NMAS), with PG 58-28.

The typical sections for the Apron, and Taxiway B are shown in Figures A-68 and A-69.

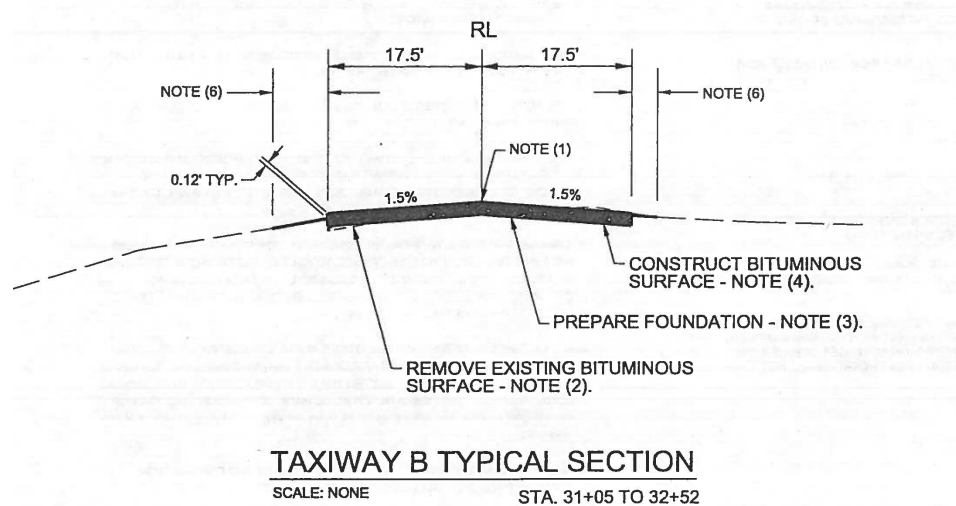

Figure A-68. Typical Section Taxiway B

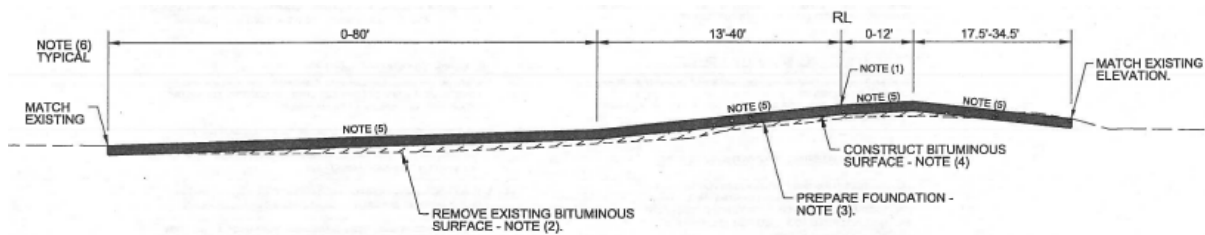

Figure A-69. Typical Section Apron

Specifications

This project used FAA specifications.

Mix Design

The mix designs for the project were not available.

Construction Report

Construction reports were not available.

Quality Control and Acceptance Results

QC and acceptance data were not available for the project.

Pavement Performance Data

Based on Pavement Management Reports provided by APTEch for pavement condition conducted in 2020:

- The Apron had a PCI rating of 87. The primary distresses included low- and medium-severity longitudinal and transverse cracking, raveling, and weathering. One hundred percent of the distress deducts were related to climate.
- Taxiway A had a PCI of 90. The primary distresses included low- and medium-severity longitudinal and transverse cracking. One hundred percent of the distress deducts were related to climate.

History of preventive or maintenance activities conducted on the airfield

There were no records of preventative maintenance activities conducted on the project.

Aircraft load and traffic data

Based on the ADIP, the overall airport traffic operation per year is as follows:

- Air carrier: 0
- Air taxi: 50
- General aviation local: 5,000
- General aviation itinerant: 2,000
- Military: 100
- TOTAL OPERATIONS: 7,150

No information about maximum aircraft gross weight was available from the ADIP.

Cumberland Municipal Airport (UBE)

Owner: City of Cumberland

Address: City Hall Box 155, Cumberland, WI 54829

Phone: 715-822-2752

Manager: Rick Brekke

Address: 224 241/2 Avenue, Cumberland, WI 54829
Phone: 715-205-4474

Description of the Airport

Cumberland Municipal Airport (UBE) is a city-owned, public-use airport located 3 miles southeast of Cumberland, a city in Barron County, Wisconsin. It is included in the FAA National Plan of Integrated Airport Systems for 2021–2025, in which it is categorized as a local general aviation facility. The airport covers 160 acres and it is located at an elevation of 1,243 ft. The airport has two runways: 09/27 (4,043 ft x 75 ft) and 18/36 (1,996 ft x 120 ft) (see Figure A-70). This project focuses on the Rehabilitation Runway 09/27, Taxiway E, and Apron.

Rehabilitation Runway 09/27, Taxiway E, and Apron

Rehabilitation date: 2015

Project Number: A.I.P. 3-55-0016-10, Contract 2

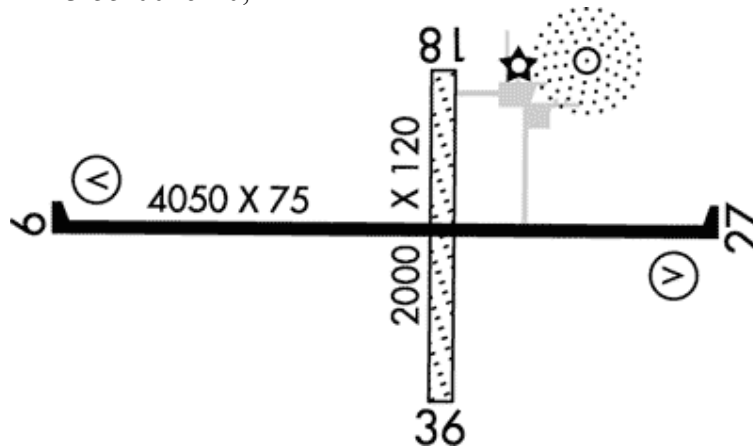

Figure A-70. Cumberland Municipal Airport (source aopa.org)

Plans

Partial information related to plans was available. The design consultant for the project was Cooper Engineering of Rice Lake, Wisconsin. The rehabilitation work was as follows: for Runway 09/27 and Taxiway E, the project consisted of milling 2.5 in. of HMA followed by the placement of two layers of HMA pavement Type E-1 (12.5-mm NMAS), each at a thickness of 1.75 in. For the Apron, the project consisted of milling 3 in. of HMA followed by the placement of two 1.75-in. layers of HMA pavement type E-3 (12.5 mm NMAS). The typical sections for Runway 09/27, Taxiway E, and the Apron can be found in Figures A-71 to A-73.

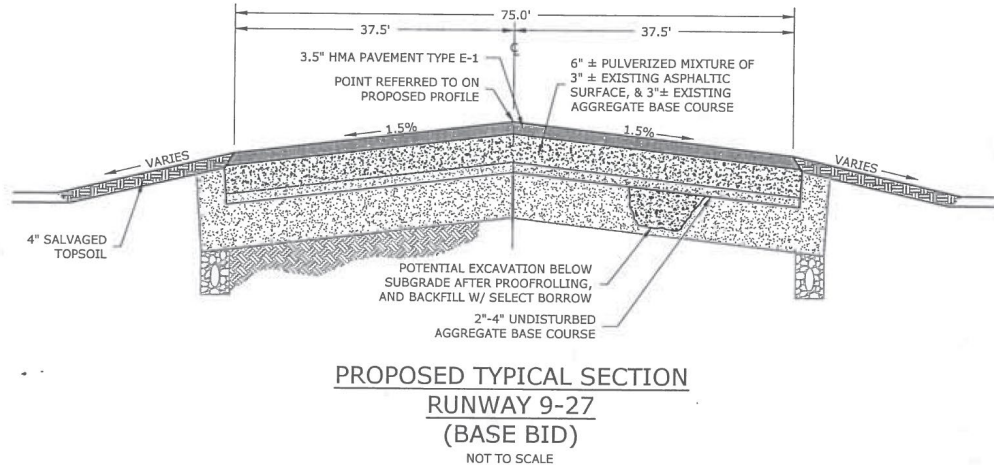

Figure A-71. Typical Section Runway 09/27

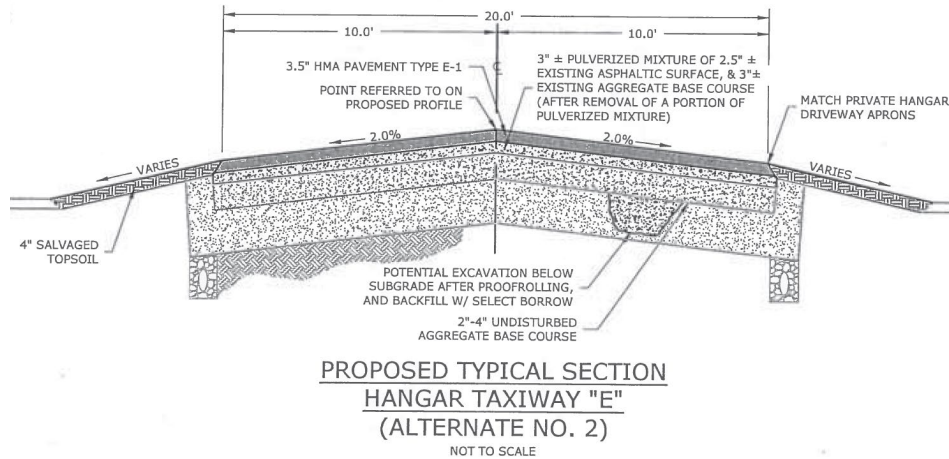

Figure A-72. Typical Section Taxiway E

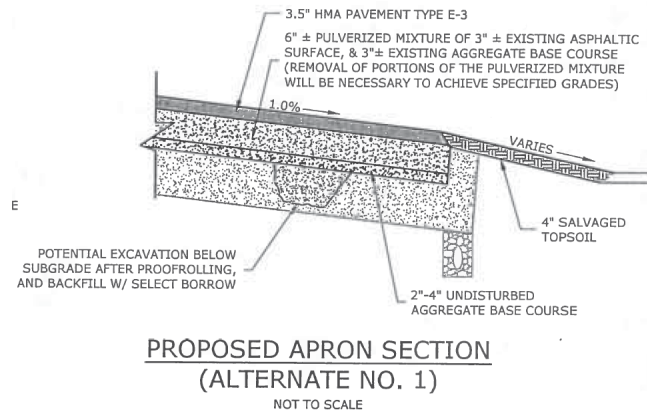

Figure A-73. Typical Section Apron

Specifications

This project used FAA specifications.

Mix Design

The mix designs for the project were not available.

Construction Report

Construction reports were not available.

Quality Control and Acceptance Results

QC and acceptance data were not available for the project.

Pavement Performance Data

Based on Pavement Management Reports provided by APTEch survey 2020:

- Runway 09/27 had a PCI rating of 75. The primary distresses included low- and medium-severity L&T cracking, and 100% of the distress deducts were related to climate.
- Apron PCI was 77. The primary distresses included alligator cracking, and low- and medium-severity L&T cracking. Twenty-one percent of the distress deducts were related to load, and 79% were related to climate.
- Taxiway E had a PCI of 83. The primary distresses included low- and medium-severity L&T cracking, and 100% of the distress deducts were related to climate.

History of preventive or maintenance activities conducted on the airfield

There were no records of preventative maintenance activities conducted on the project.

Aircraft load and traffic data

Based on the ADIP, the overall airport traffic operation per year is as follows:

- Air carrier: 0
- Air taxi: 0
- General aviation local: 2,900
- General aviation itinerant: 8,000
- Military: 0
- TOTAL OPERATIONS: 10,900

No information about maximum aircraft gross weight was available on the ADIP.

East Troy Municipal Airport

Owner: Village of East Troy
Address: 2015 Energy Drive, East Troy, WI 53120
Phone: 262-642-6255

Manager: Walter Watkins
Address: P.O. Box 57, Fontana, WI 53125
Phone: 262-215-2949

Description of the Airport

East Troy Municipal Airport (57C) is a village-owned, public-use airport located 2 miles northeast of East Troy, Wisconsin, a village in Walworth County, Wisconsin. It is included in the FAA National Plan of Integrated Airport Systems for 2019–2023, where it is categorized as a local general aviation facility.

The airport covers 214 acres and is located at an elevation of 860 ft. The airport has two runways: 08/26 (3,900 ft x 75 ft) and 18/36 (2,446 ft x 100 ft) (see Figure A-74). This report focuses on the reconstruction of Runway 08/26 in 2014, and the construction of Taxiway B in 2003.

Reconstruct Runway 08/26

Reconstruction date: 2014
Project Number AIP 3-55-0018-08

Construction of Taxiway B

Construction date: 2003
No information was available regarding Project Number.



Figure A-74. East Troy Municipal Airport (open street map)

Plans

Partial information related to plans was available for the reconstruction of Runway 08/26. The design consultant for the project was Nielsen Madsen & Barber S.C. of Racine, Wisconsin.

The reconstruction work of Runway 08/26 consisted of milling existing asphalt pavement and constructing new asphaltic concrete pavement in two lifts: 2.25-in. lower course (19mm NMAS) and 1.75-in. upper course (12.5 mm NMAS).

The typical section for Runway 08/26 is shown in Figure A-75.

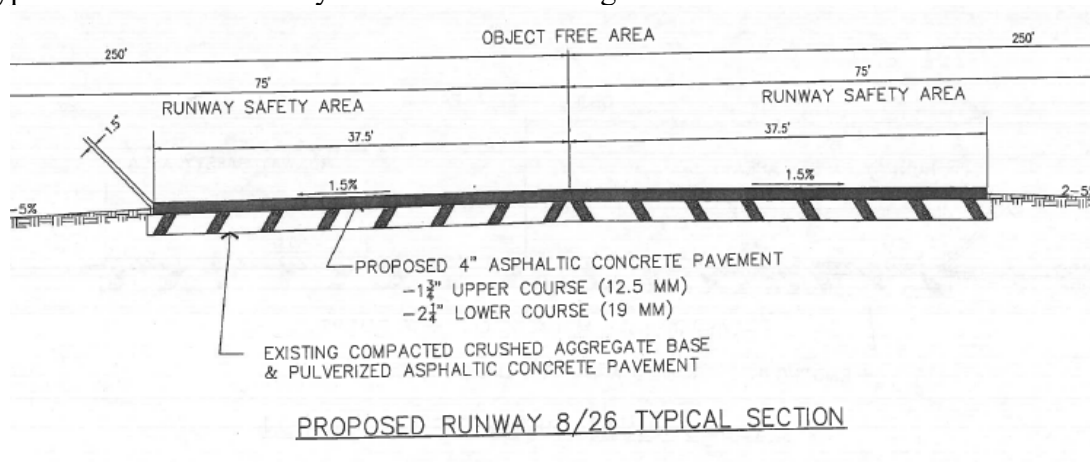

Figure A-75. Typical Section Runaway 08/26

Specifications

The reconstruction of Runway 08/26 used FAA specifications.

The construction of Taxiway B used Highway specifications.

Mix Design

The mix designs for the project were not available.

Construction Report

Construction reports were not available.

Quality Control and Acceptance Results

QC and acceptance data were not available for the project.

Pavement performance data

Based on Pavement Management Reports provided by APTech for pavement condition conducted in 2018:

- Runway 08/26 had a PCI rating of 76. The primary distresses included low-severity L&T cracking, and weathering. One hundred percent of the distress deducts were related to climate.
- Taxiway B had a PCI rating of 61. The primary distresses included medium-severity alligator cracking, low- and medium-severity longitudinal and transverse cracking, and low- and medium-severity weathering. Thirty-three percent of the distress deducts were related to load, and 67% were related to climate.

History of preventive or maintenance activities conducted on the airfield

There were no records of preventative maintenance activities conducted on the project.

Aircraft load and traffic data

Based on the ADIP, the overall airport traffic operation per year is as follows:

- Air carrier: 0
- Air taxi: 800
- General aviation local: 20,000
- General aviation itinerant: 20,000
- Military: 200
- TOTAL OPERATIONS: 41,000

Based on the ADIP, Runway 18/26 is subjected to the following maximum aircraft gross weights:

- Single wheel: 12,000 lb

Fond Du Lac County Airport

Owner: Fond Du Lac County
Address: 160 S Macy, Fond Du Lac, WI 54935
Phone: 920-922-4162

Manager: Jim Thomas
Address: N 6308 Rolling Meadows Drive, Fond Du Lac, WI 54937
Phone: 920-926-0653

Description of the Airport

Fond Du Lac County Airport (FLD) is a county-owned, public-use airport located 1 mile west of Fond du Lac, a city in Fond du Lac County, Wisconsin. It is included in the FAA National Plan of Integrated Airport Systems for 2019–2023, where it is categorized as a regional general aviation facility. The airport covers an area of 586 acres at an elevation of 808 ft. It has two runways: 18/36 (5,941 ft x 100 ft) and 09/27 (1,098 ft x 75 ft) (see Figure A-76). This report focuses on the Apron area.

Reconstruct Apron

Reconstruction date: 2007.

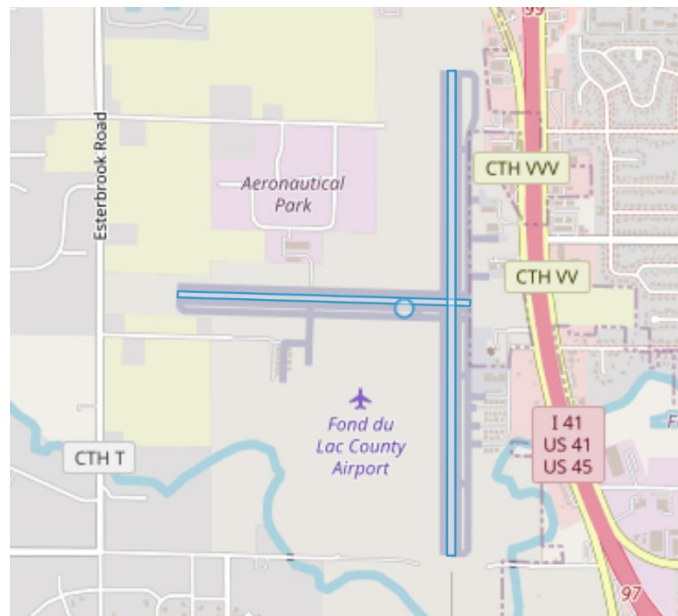

Figure A-76. Fond Du Lac County Airport (open street map)

Plans

Plans were not available.

Specifications

This project used FAA specifications.

Mix Design

The mix designs for the project were not available.

Construction Report

Construction reports were not available.

Quality Control and Acceptance Results

QC and acceptance data were not available for the project.

Pavement performance data

Based on Pavement Management Reports provided by APTEch for pavement condition conducted in 2019:

- Apron had a PCI rating of 69. The primary distresses included low- and medium-severity longitudinal and transverse cracking, moderate and high weathering, and low depression. Ninety-six percent of the distress deducts were related to climate and 4% to other distresses.

History of preventive or maintenance activities conducted on the airfield

There were no records of preventative maintenance activities conducted on the project.

Park Falls Municipal

Owner: City of Park Falls

Address: City Hall, 400 4th Avenue South, Park Falls, WI 54552

Phone: 715-762-2436

Manager: Spike Macgregor

Address: 1048 Marian Lane, Park Falls, WI 54552

Phone: 715-661-3500

Description of the Airport

Park Falls Municipal Airport (PKF) is a city-owned, public airport located 2 nautical miles northeast of Park Falls, a city in Price County, Wisconsin. It is included in the FAA National Plan of Integrated Airport Systems for 2021–2025, where it is categorized as a basic general aviation facility. The airport covers 72 acres and is located at an elevation of 1,501 ft. The airport has one runway: 18/26 (3,200 ft x 60 ft) (see Figure A-77). This report focuses on the reconstruction of Runway 18/36.

Reconstruct Runway 18/36

Reconstruction date: 2015

Project Number AIP 3-55-0063-13



Figure A-77. Park Falls Municipal Airport (open street map)

Plans

Partial information related to plans was available. The design consultant for the project was Cooper Engineering of Rice Lake, Wisconsin. The reconstruction of Runway 18/36 was as follows: milling 2 in. of asphaltic pavement followed by the placement of two layers of HMA pavement Type E-3 each at a thickness of 1.5 in., with PF 64-34. Binder mat was 12.5 mm NMAS and surface mat 9.5 mm NMAS. The typical section for the Runway 18/36 is shown in Figure A-78.

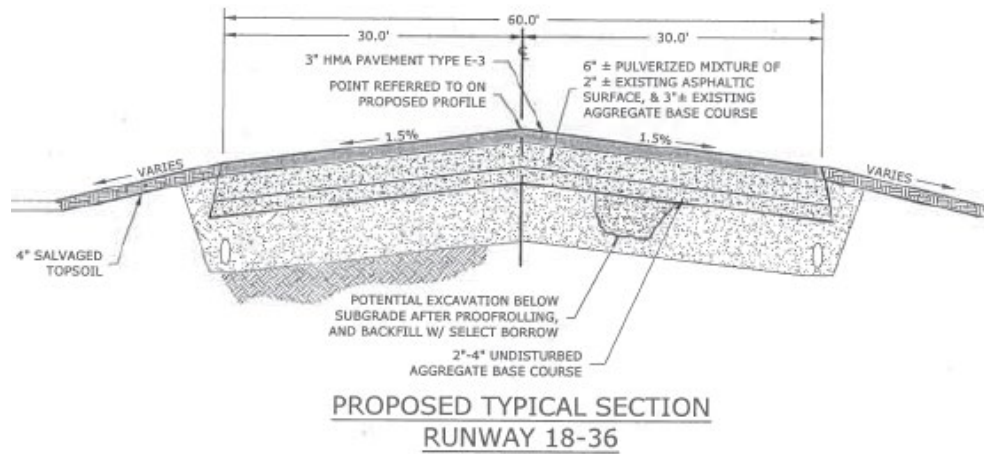

Figure A-78. Typical Section Runway 18/36

Specifications

This project used FAA specifications.

Mix Design

The mix designs for the project were not available.

Construction Report

Construction reports were not available.

Quality Control and Acceptance Results

QC and acceptance data were not available for the project.

Pavement performance data

Based on Pavement Management Reports provided by APTEch for pavement condition conducted in 2018:

- Runway 18/36 had a PCI rating of 73. The primary distresses included low- and medium-severity L&T cracking, and weathering. One hundred percent of the distress deducts were related to climate.

History of preventive or maintenance activities conducted on the airfield

There were no records of preventative maintenance activities conducted on the project.

Aircraft load and traffic data

Based on the ADIP, the overall airport traffic operation per year is as follows:

- Air carrier: 0

- Air taxi: 200
- General aviation local: 2,700
- General aviation itinerant: 3,850
- Military: 0
- TOTAL OPERATIONS: 6,750

Based on the ADIP, Runway 18/36 is subjected to the following loads:

- Single wheel: 20,000 lb

APPENDIX B—COMPARISON OF STATE AND FAA SPECIFICATIONS

Georgia

A review of the Georgia Department of Transportation (GDOT) surface course specification (2013, Sections 400 and 800), as compared to the current Federal Aviation Administration (FAA) surface source specification (P-401), identified the following significant differences:

Coarse aggregate: For the Clay Lumps & Friable particles test, the GDOT requirement is a maximum of 1% (FAA requirement is a maximum of 0.3%). The GDOT specification has a flat and elongated requirement of maximum 10%, whereas FAA specifies a maximum of 8%. GDOT allows the use of mica schist (10% maximum) and glassy particles or slag (30% maximum).

Fine aggregate: The GDOT specification does not have a liquid limit, plasticity index, or soundness and clay lumps and friable particles requirements. Sand equivalent requirements vary in the GDOT specifications based on the aggregate source.

Bituminous material: GDOT specification requires performance graded (PG) 67-22 for all mixtures. For mixtures containing reclaimed asphalt pavement (RAP), the engineer determines the PG grade. PG 76-22 is required as specified by the Design Engineer.

Mix design criteria: The Superpave design method is used following AASHTO TP 4 and PP 2D (updated to T 312 and R 30, respectively). The FAA requirement is 75 (>60,000) and 50 (<60,000). The GDOT specification does contain an Asphalt Pavement Analyzer (APA) rut test of 6.0 mm maximum (100 psi hose pressure at 64°C), whereas FAA specifies 5.0 mm under the same testing conditions.

Placement requirements: Indiana Department of Transportation (INDOT) does not specify an offset for the transverse joint, whereas the FAA requirement is 10 ft.

Longitudinal joints: The GDOT specification does not specify any type of joint, whereas the FAA requirement specifies that they should be cut back if they are left exposed for more than 4 hours or have cooled to less than 175 °F. With respect to joint density, GDOT does not require a minimum density.

Acceptance: GDOT specifies the lot size as 1 day's production. The tests performed are asphalt content, gradation (3/8, No. 4 and No. 8 sieves), in-place air voids, and smoothness. Maximum pavement mean air void is 7.8% (92.2% G_{mm}). Acceptance is based on pavement mean air voids (density); pay factors for binder content; 3/8, No.4, and No. 8 sieves; and smoothness index. The FAA specification defines a lot as 1 day's production divided into equal sublots of 400–600 tons each. The FAA also uses a percent within limits specification. However, their acceptance quality characteristics (AQC) include mat density, joint density, air voids, grade, and smoothness.

Smoothness: GDOT requires to straightedge transverse joints immediately after forming the joint and to correct any irregularity that exceeds 3/16 in. in 10 ft (5 mm in 3 m). The

FAA uses either a profilograph or an inertial profiler but does not specify corrections on transverse joints.

Illinois

The specifications for the project were the Illinois Standard Specifications for Construction of Airports, published by the Illinois Department of Transportation, Division of Aeronautics, with a published date of April 1, 2012. A review of the Illinois surface course specification (Item 401), as compared to the current FAA surface source specification (P-401), identified the following significant differences:

Coarse aggregate: For the sodium sulfate soundness test, the Illinois Department of Transportation (ILDOT) requirement is a maximum of 15% (FAA requirement is a maximum of 12%). The ILDOT specification does not have any flat and elongated requirements nor does it have a fractured faces requirement.

Fine aggregate: The ILDOT specification does not have a liquid limit or plasticity index requirement. The soundness requirement is a maximum of 15% (FAA is 10%). The ILDOT specification also allows more clay lumps, friable particles, and natural sand, and does not have a sand equivalent requirement.

Bituminous material: ILDOT specification requires a PG 64-22 binder unless otherwise specified. There are no PG+ requirements nor provisions for grade bumping in the specification.

Mix design criteria: For N_{design} , ILDOT requires 40 gyrations for >60,000 lb and 30 gyrations for under 60,000 lb. The FAA requirement is 75 (>60,000) and 50 (<60,000). The ILDOT specification does not contain an APA rut test. The target air voids are determined by the ILDOT Division of Aeronautics on a case-by-case basis within the range of 2%–4%. ILDOT also specifies voids filled with asphalt and doesn't specify voids in the mineral aggregate (VMA) (probably because the design air voids vary).

Construction test section: The ILDOT specification requires a minimum density of 94.0% G_{mm} , whereas the FAA requires 94.5% in the test section.

Placement requirements: ILDOT specifications require only a 2-ft offset with respect to the placement of underlying transverse joints, whereas the FAA requirement is 10 ft.

Longitudinal joints: The ILDOT specification requires the longitudinal joints to be cut back only if they are “irregular, damaged, or otherwise defective,” whereas the FAA requires that they be cut back if they are left exposed for more than 4 hours or have cooled to less than 175 °F. With respect to joint density, ILDOT requires a minimum density of 90%, whereas the FAA requirement is 92.5%.

Acceptance: For lot sizes, ILDOT defines a lot as four sublots of 500 tons each. The FAA specification defines a lot as 1 day's production divided into equal sublots of between 400 and 600 tons each. The ILDOT specifications use a PWL specification for in-place air voids (density) acceptance with the specification limits of 1%–7%. A PWL of 90% equates

to 100% pay. The FAA also uses a PWL specification. However, their acceptance quality characteristics (AQC) include mat density, joint density, air voids, grade, and smoothness.

Smoothness: The ILDOT specifications use a 16-ft straightedge placed parallel to the centerline. Any humps or depressions exceeding 1/4 in. must be corrected. The FAA uses either a profilograph or an inertial profiler.

Indiana

A review of the Indiana surface course specification (2008 Sections 400 and 900), as compared to the current FAA surface source specification (P-401), identified the following significant differences:

Coarse aggregate: For the Clay Lumps & Friable particles test, the INDOT requirement is a maximum of 1% (FAA requirement is a maximum of 0.3%). The INDOT specification has a flat and elongated requirement of maximum 10%, whereas the FAA specifies a maximum of 8%.

Fine aggregate: The INDOT specification does not have a liquid limit or plasticity index requirement.

Bituminous material: INDOT requires PG 58-28 and PG 64-28 binder for mixtures containing greater than 15% RAP. Binders PG 64-22, 70-22, and 76-22 are required for mixes without RAP.

Mix design criteria: The Superpave design method is used following a modified AASHTO M 323 criteria. The FAA requirement is 75 (>60,000) and 50 (<60,000). The INDOT specification does not contain an APA rut test.

Construction test section: INDOT requires a minimum density of 94.0% G_{mm} , whereas the FAA requires 94.5% in the test section.

Placement requirements: INDOT does not specify an offset for the transverse joint, while the FAA requirement is 10 ft.

Longitudinal joints: INDOT does not specify any type of joint, whereas the FAA requires that they be cut back if they are left exposed for more than 4 hours or have cooled to less than 175 °F. INDOT does not require a minimum joint density.

Acceptance: For lot sizes, INDOT defines a lot as 4 sublots of 600 tons each. The FAA specification defines a lot as 1 day's production divided into equal sublots of 400–600 tons each. The 2008 INDOT specifications use a composite pay factor for binder content, air voids at N_{design} , VMA at N_{design} , and field density. The FAA also uses a PWL specification. However, their AQC include mat density, joint density, air voids, grade, and smoothness.

Smoothness: The INDOT specifications allows the use of 16-ft or 10-ft straightedges and profilographs. Payment was based on a zero blanking band on the final profile index. The FAA uses either a profilograph or an inertial profiler.

Michigan:

The specifications for the projects were published by the Michigan Department of Transportation Airports Division, with an FAA approval date of October 2007. A review of the P-411 specifications (Plant Mix Bituminous Pavements) as compared to the current FAA surface course specification (P-401) identified the following significant differences:

Coarse aggregate: The Michigan Department of Transportation (MDOT) specification does not include a soundness requirement (FAA requires a 12% maximum for sodium sulfate and an 18% maximum for magnesium sulfate). It also allows up to 5% of soft particles (the P-401 specification limits clay lumps and friable particles to a 1% maximum).

Fine aggregate: The MDOT specification does not require soundness on fine aggregate, whereas the FAA requires a 10% maximum for sodium sulfate and a 15% maximum for magnesium sulfate. The MDOT does not have restrictions on natural sand, whereas the FAA limits sand from 0% to 15%. The MDOT specification has a maximum plasticity index of 8 percent, whereas the FAA maximum is 4%.

Bituminous material: The type of binder used is specified in the plans or other contract documents. Specified binders include: PG 58-22, 58-28, 58-34, PG 64-22, 64-28, 64-34. No provisions for grade bumping or PG+ requirements are specified.

Mix design criteria: For pavements with aircraft gross weights <60,000 lb and tire pressure <100 psi: the Marshall Mix Design method (50 blow) is used in accordance with Asphalt Institute's MS-2. Design air voids are 2.5%. The nominal maximum aggregate size of the mixture is 12.5 mm. Minimum VMA is 14.5%. Minimum stability is 1,000 lb. Flow is 8–18. Reclaimed asphalt pavement is not permitted unless stated otherwise in the contract.

Construction test section: MDOT specifications require in-place air voids of 1.0%–7.0% (93.0%–99.0% G_{mm})

Placement requirements: Longitudinal joints must be offset by 1 ft. Transverse joints in adjacent lanes and previously placed layers shall be offset 10 ft.

Longitudinal joints: Does not require cutback joints.

Acceptance: Lot is 1 day's production or 2,000 tons. Binder content and gradation (2 times per day) has to fall within specified limits. Density is four sublots. PWL spec has limits at 1%–7%. There is no density requirement on the joint.

Smoothness: 16 ft straightedge.

APPENDIX C—SUMMARY OF DISTRESSES

The individual airport distresses and distress deducts for each of the airports included in this study follow. They are summarized by airport, runway number, and by section number. During a PCI inspection, the pavement is divided into branches that are divided into sections. Each section is divided into sample units. The type and severity of each type of airport pavement distress is assessed by visual inspection of the pavement sample units. The quantity of the distress is measured as described in Appendix X1 and Appendix X2 of ASTM D5340. The distress data are then used to calculate the PCI for each sample unit. The PCI of the pavement section is determined based on the PCI of the inspected sample units within the section.

A brief description of each item in the summaries is as follows:

- Distress: Code used by the PAVER™ Distress Identification Manual to categorize the distress into one of sixteen distress types.
- Description: A brief description of the type of distress being reported.
- Severity: Description of how severe the distress is, based on low, medium, and high.
- Quantity: Total amount of distress measured in that section.
- Units: Unit of measure for the type of distress.
- Density: Intensity of the distresses based on the quantity of distresses divided by the total section size.
- Deduct: Deduct values based on charts in Appendix X3 of ASTM D5340.

The deducts are then characterized into one of three categories: load related, climate related, and other and a percentage for each category is determined.

Table C-1. Columbus Airport (CSG) - Runways 06/24 and 13/31

Columbus Runway 6-24 Section 10C									
Distress	Description	Severity	Quantity	Units	Density	Deduct	% of Distress Deduct		
48	L & T CR	L	13,918.00	Ft	5.96	16.73	Load	Climate	Other
56	SWELLING	L	301.00	SqFt	0.13	1.25	0	93	7
Columbus Runway 6-24 Section 10E									
Distress	Description	Severity	Quantity	Units	Density	Deduct	% of Distress Deduct		
48	L & T CR	M	801.00	Ft	0.34	6.94	Load	Climate	Other
48	L & T CR	L	18,579.00	Ft	7.96	20.27	0	95	5
56	SWELLING	L	334.00	SqFt	0.14	1.33			
Columbus Runway 6-24 Section 10W									
Distress	Description	Severity	Quantity	Units	Density	Deduct	% of Distress Deduct		
48	L & T CR	M	134.00	Ft	0.06	4	Load	Climate	Other
48	L & T CR	L	18,706.00	Ft	8.01	20.35	0	95	5
56	SWELLING	L	287.00	SqFt	0.12	1.22			
Columbus Runway 12-30 Section 10									
Distress	Description	Severity	Quantity	Units	Density	Deduct	% of Distress Deduct		
48	L & T CR	L	7,256.00	Ft	2.68	9.21	Load	Climate	Other
							0	100	0
Columbus Runway 12-30 Section 20									
Distress	Description	Severity	Quantity	Units	Density	Deduct	% of Distress Deduct		
48	L & T CR	L	750.00	Ft	2.89	9.76	Load	Climate	Other
							0	100	0
Columbus Runway 12-30 Section 30									
Distress	Description	Severity	Quantity	Units	Density	Deduct	% of Distress Deduct		
							Load	Climate	Other
							0	0	0

Table C-2. Winder-Barrow County Airport (WDR)—Runways 05/23 and 13/31

Winder Runway 5-23 Section 10									
Distress	Description	Severity	Quantity	Units	Density	Deduct	% of Distress Deduct		
48	L & T CR	L	35,741.00	Ft	8.77	21.53	Load	Climate	Other
57	WEATHERING	L	407,373.00	SqFt	100	5.96	0	100	0
Winder Runway 13-31 Section 10									
Distress	Description	Severity	Quantity	Units	Density	Deduct	% of Distress Deduct		
48	L & T CR	L	16,488.00	Ft	2.79	9.51	Load	Climate	Other
52	RAVELING	L	493.00	SqFt	0.08	1	0	100	0
57	WEATHERING	L	59,061.00	SqFt	10	1.72			

Table C-3. Dahlonega–Wimpy’s Lumpkin County Airport (9A0)—Runway 15/33

Dahlonega Runway 15-33 Section 10									
Distress	Description	Severity	Quantity	Units	Density	Deduct	% of Distress Deduct		
48	L & T CR	L	1,428.00	Ft	0.92	4.78	Load	Climate	Other
							0	100	0

Table C-4. Waukegan National Airport (UGN)—Runway 14/32

Waukegan Runway 14-32 Section 1									
Description	Distress	Severity	Quantity	Units	Density	Deduct	% of Distress Deduct		
							Load	Climate	Other
JT REF. CR	47	Low	625.50	Ft	1.85	5.25			
JT REF. CR	47	Medium	721.50	Ft	2.14	16.73	0	100	0
L & T CR	48	Low	243.00	Ft	0.72	4.42			
L & T CR	48	Medium	576.00	Ft	1.71	14.49			
WEATHERING	57	Medium	33,750.00	SqFt	100.00	20.34			
Waukegan Runway 14-32 Section 2									
Description	Distress	Severity	Quantity	Units	Density	Deduct	% of Distress Deduct		
							Load	Climate	Other
JT REF. CR	47	Low	2,232.00	Ft	2.20	6.06			
JT REF. CR	47	Medium	1,548.00	Ft	1.53	13.00	0	100	0
L & T CR	48	Low	432.00	Ft	0.43	3.93			
L & T CR	48	Medium	864.00	Ft	0.85	10.47			
SWELLING	56	Low	216.00	SqFt	0.21	1.50			
WEATHERING	57	Medium	101,250.00	SqFt	100.00	20.34			
Waukegan Runway 14-32 Section 3									
Description	Distress	Severity	Quantity	Units	Density	Deduct	% of Distress Deduct		
							Load	Climate	Other
JT REF. CR	47	Low	700.00	Ft	3.11	7.85			
JT REF. CR	47	Medium	300.00	Ft	1.33	11.61	0	84	16
L & T CR	48	Low	464.00	Ft	2.06	7.58			
L & T CR	48	Medium	366.67	Ft	1.63	14.16			
SWELLING	56	Medium	97.33	SqFt	0.43	11.81			
WEATHERING	57	Medium	22,500.00	SqFt	100.00	20.34			
Waukegan Runway 14-32 Section 4A									
Description	Distress	Severity	Quantity	Units	Density	Deduct	% of Distress Deduct		
							Load	Climate	Other
L & T CR	48	Low	249.00	Ft	2.37	8.40			
L & T CR	48	Medium	277.00	Ft	2.64	18.18	0	98	2
SWELLING	56	Low	6.00	SqFt	0.06	1.00			
WEATHERING	57	Medium	10,500.00	SqFt	100.00	20.34			
Waukegan Runway 14-32 Section 5A									
Description	Distress	Severity	Quantity	Units	Density	Deduct	% of Distress Deduct		
							Load	Climate	Other
L & T CR	48	Low	455.00	Ft	6.07	16.93			
L & T CR	48	Medium	100.00	Ft	1.33	12.84	0	100	0
WEATHERING	57	Medium	7,500.00	SqFt	100.00	20.34			
Waukegan Runway 14-32 Section 6									
Description	Distress	Severity	Quantity	Units	Density	Deduct	% of Distress Deduct		
							Load	Climate	Other
JT REF. CR	47	Low	375.00	Ft	3.33	8.24			
L & T CR	48	Low	110.00	Ft	0.98	4.90	0	100	0
L & T CR	48	Medium	80.00	Ft	0.71	9.67			
WEATHERING	57	Medium	11,250.00	SqFt	100.00	20.34			
Waukegan Runway 14-32 Section 7									
Description	Distress	Severity	Quantity	Units	Density	Deduct	% of Distress Deduct		
							Load	Climate	Other
JT REF. CR	47	Low	600.00	Ft	1.78	5.06			
JT REF. CR	47	Medium	750.00	Ft	2.22	17.19	0	55	45
L & T CR	48	Low	318.00	Ft	0.94	4.83			
L & T CR	48	Medium	57.00	Ft	0.17	4.67			
SWELLING	56	High	120.00	SqFt	0.36	30.24			
SWELLING	56	Medium	120.00	SqFt	0.36	11.56			
WEATHERING	57	Medium	33,750.00	SqFt	100.00	20.34			

Table C-5. Bolingbrook's Clow International Airport (1C5)—Runway 18/36

Bolingbrook Runway 18-36 Section 1									
Description	Distress	Severity	Quantity	Units	Density	Deduct	% of Distress Deduct		
							Load	Climate	Other
L & T CR	48	Low	9,246.29	Ft	3.74	11.89			

Bolingbrook Runway 18-36 Section 1									
Description	Distress	Severity	Quantity	Units	Density	Deduct	% of Distress Deduct		
RAVELING	52	Low	11,062.86	SqFt	4.47	6.39	0	100	0
WEATHERING	57	Low	247,500.00	SqFt	100.00	5.96			

Table C-6. DuPage Airport (DPA)—Runway 10/28

DuPage Runway 10-28 Section 1									
Description	Distress	Severity	Quantity	Units	Density	Deduct	% of Distress Deduct		
ALLIGATOR CR	41	Low	891.43	SqFt	0.3	11.4	Load	Climate	Other
L & T CR	48	Low	13,152.00	Ft	4.9	14.5	36	64	0
WEATHERING	57	Low	270,000.00	SqFt	100.0	6.0			
DuPage Runway 10-28 Section 2									
Description	Distress	Severity	Quantity	Units	Density	Deduct	% of Distress Deduct		
L & T CR	48	Low	2,420.00	Ft	4.3	13.2	Load	Climate	Other
WEATHERING	57	Low	56,250.00	SqFt	100.0	6.0	0	0	0

Table C-7. Chicago Executive Airport (PWK)—Runway 16/34

Wheeling Chicago Runway 16-34 Section 1									
Description	Distress	Severity	Quantity	Units	Density	Deduct	% of Distress Deduct		
L & T CR	48	Low	2,325.00	Ft	3.10	10.30	Load	Climate	Other
L & T CR	48	Medium	150.00	Ft	0.20	5.15	0	100	0
WEATHERING	57	Low	55,680.00	SqFt	74.24	5.59			
Wheeling Chicago Runway 16-34 Section 2									
Description	Distress	Severity	Quantity	Units	Density	Deduct	% of Distress Deduct		
L & T CR	48	Low	2,580.00	Ft	4.30	13.22	Load	Climate	Other
L & T CR	48	Medium	60.00	Ft	0.10	4.00	0	100	0
RAVELING	52	Medium	4.80	SqFt	0.01	4.00			
WEATHERING	57	Low	59,995.20	SqFt	99.99	5.96			
Wheeling Chicago Runway 16-34 Section 3									
Description	Distress	Severity	Quantity	Units	Density	Deduct	% of Distress Deduct		
L & T CR	48	Low	10,276.29	Ft	3.61	11.57	Load	Climate	Other
L & T CR	48	Medium	40.71	Ft	0.01	4.00	0	100	0
PATCHING	50	Low	2,646.43	SqFt	0.93	3.40			
RAVELING	52	High	40.71	SqFt	0.01	6.00			
WEATHERING	57	Low	282,312.86	SqFt	99.06	5.95			
Wheeling Chicago Runway 16-34 Section 4									
Description	Distress	Severity	Quantity	Units	Density	Deduct	% of Distress Deduct		
L & T CR	48	Low	5,855.57	Ft	3.00	10.05	Load	Climate	Other
L & T CR	48	Medium	1,170.00	Ft	0.60	8.99	0	100	0
PATCHING	50	Low	1,002.86	SqFt	0.51	2.50			
RAVELING	52	Low	11.14	SqFt	0.01	1.00			
WEATHERING	57	Low	193,930.29	SqFt	99.45	5.96			
WEATHERING	57	Medium	55.71	SqFt	0.03	1.20			
Wheeling Chicago Runway 16-34 Section 5									
Description	Distress	Severity	Quantity	Units	Density	Deduct	% of Distress Deduct		
L & T CR	48	Low	4,109.00	Ft	3.91	12.31	Load	Climate	Other
L & T CR	48	Medium	227.50	Ft	0.22	5.39	0	100	0
WEATHERING	57	Low	105,000.00	SqFt	100.00	5.96			

Table C-8. Anderson Municipal Airport (AID)—Taxiway A, Sections 5, 10, & 15

Anderson Taxiway A Section 05									
Distress	Description	Severity	Quantity	Units	Density	Deduct	% of Distress Deduct		
48	L & T CR	M	3,458.00	Ft	6.48	29.44	Load	Climate	Other
48	L & T CR	L	2,669.00	Ft	5	14.77	0	100	0
52	RAVELING	L	2,256.00	SqFt	4.23	6.19			

Anderson Taxiway A Section 05									
Distress	Description	Severity	Quantity	Units	Density	Deduct	% of Distress Deduct		
57	WEATHERING	L	53,361.00	SqFt	100	5.96			
Anderson Taxiway A Section 10									
Distress	Description	Severity	Quantity	Units	Density	Deduct	% of Distress Deduct		
48	L & T CR	M	2,932.00	Ft	2.47	17.54	Load	Climate	Other
48	L & T CR	L	3,289.00	Ft	2.77	9.44	0	100	0
48	L & T CR	H	148.00	Ft	0.12	8.4			
57	WEATHERING	L	118,845.00	SqFt	100	5.96			
Anderson Taxiway A Section 15									
Distress	Description	Severity	Quantity	Units	Density	Deduct	% of Distress Deduct		
48	L & T CR	M	10,596.00	Ft	6.23	28.86	Load	Climate	Other
48	L & T CR	L	7,711.00	Ft	4.54	13.75	15	85	0
53	RUTTING	L	80.00	SqFt	0.05	8.5			
57	WEATHERING	L	169,944.00	SqFt	100	5.96			

Table C-9. Columbus Municipal (BAK)—Taxiway D

Columbus Taxiway D Section 10									
Distress	Description	Severity	Quantity	Units	Density	Deduct	% of Distress Deduct		
48	L & T CR	L	5,624.00	Ft	2.94	9.88	Load	Climate	Other
57	WEATHERING	M	438.00	SqFt	0.23	1.27	0	100	0
57	WEATHERING	L	191,035.00	SqFt	99.77	5.96			

Table C-10. Logansport-Cass County (GGP)—Runway 09/27

Logansport Runway 9-27 Section 10									
Distress	Description	Severity	Quantity	Units	Density	Deduct	% of Distress Deduct		
48	L & T CR	M	8,791.00	Ft	2.84	18.9	Load	Climate	Other
48	L & T CR	L	29,935.00	Ft	9.66	22.8	14	85	1
48	L & T CR	H	129.00	Ft	0.04	7.5			
52	RAVELING	L	22,964.00	SqFt	7.41	8.42			
53	RUTTING	L	827.00	SqFt	0.27	10.65			
56	SWELLING	L	138.00	SqFt	0.04	1			
57	WEATHERING	L	310,003.00	SqFt	100	5.96			

Table C-11. Peru Municipal (I76)—Runway 01/19

Peru Runway 1-19 Section 20									
Distress	Description	Severity	Quantity	Units	Density	Deduct	% of Distress Deduct		
48	L & T CR	M	520.00	Ft	0.17	4.74	Load	Climate	Other
48	L & T CR	L	13,050.00	Ft	4.35	13.33	0	100	0
57	WEATHERING	L	300,000.00	SqFt	100	5.96			

Table C-12. Cheboygan County Airport (SLH)—Runway 17/35

Cheboygan Runway 17-35									
Distress	Description	Severity	Quantity	Units	Density	Deduct	% of Distress Deduct		
41	ALLIGATOR CR	L	146.00	SqFt	0.12	7.07	Load	Climate	Other
48	L & T CR	M	431.00	Ft	0.34	6.96	17	49	34
48	L & T CR	L	2,264.00	Ft	1.81	6.91			
56	SWELLING	M	695.00	SqFt	0.56	12.24			
56	SWELLING	L	313.00	SqFt	0.25	1.55			
57	WEATHERING	L	104,171.00	SqFt	83.33	5.77			

Table C-13. Houghton County Memorial Airport (CMX)—Runway 07/25

Houghton Runway 7-25 Section 10									
Distress	Description	Severity	Quantity	Units	Density	Deduct	% of Distress Deduct		
48	L & T CR	L	503.00	Ft	0.11	2.49	Load	Climate	Other
52	RAVELING	L	47,417.00	SqFt	10	9.83	0	100	0
57	WEATHERING	L	474,166.00	SqFt	100	5.96			

Table C-14. Kirsch Municipal Airport (IRS)—Runway 06/24

Kirsch Runway 6-24 Section 10									
Distress	Description	Severity	Quantity	Units	Density	Deduct	% of Distress Deduct		
48	L & T CR	L	2,380.00	Ft	0.95	4.85	Load	Climate	Other
52	RAVELING	L	13,328.00	SqFt	5.33	7.05	0	100	0
57	WEATHERING	L	249,892.00	SqFt	100	5.96			

Table C-15. Marlette Township Airport (77G)—Runway 01/19

Marlette Runway 1-19 Section 10									
Distress	Description	Severity	Quantity	Units	Density	Deduct	% of Distress Deduct		
48	L & T CR	L	3,912.00	Ft	1.42	5.91	Load	Climate	Other
57	WEATHERING	L	243,259.00	SqFt	88.21	5.84	0	100	0

Table C-16. Oakland County International Airport (PTK)—Runway 18/36

Oakland Runway 18-36 Section 10									
Distress	Description	Severity	Quantity	Units	Density	Deduct	% of Distress Deduct		
48	L & T CR	M	8,984.00	Ft	3.96	22.66	Load	Climate	Other
48	L & T CR	L	6,364.00	Ft	2.81	9.54	0	100	0
48	L & T CR	H	432.00	Ft	0.19	10.03			
57	WEATHERING	M	226,749.00	SqFt	100	20.34			

C-17. St. Clair County International Airport (PHN)—Runway 10/28

St. Clair County International Airport—Runway 10/28									
Distress	Description	Severity	Quantity	Units	Density	Deduct	% of Distress Deduct		
48	L & T CR	M	11,770.00	Ft	3.93	22.57	Load	Climate	Other
48	L & T CR	L	4,080.00	Ft	1.36	5.77	0	100	0
50	PATCHING	L	600.00	SqFt	0.2	2.02			
52	RAVELING	L	12,679.00	SqFt	4.24	6.2			
57	WEATHERING	M	53,207.00	SqFt	17.78	8.08			
57	WEATHERING	L	245,482.00	SqFt	82.02	5.75			

Table C-18. Prairie du Chien (PDC)—Runway 11/29

Prairie Du Chien Runway 11-29 Section 10									
Distress	Description	Severity	Quantity	Units	Density	Deduct	% of Distress Deduct		
							Load	Climate	Other
41	ALLIGATOR CR	L	639.00	SqFt	0.21	8.74			
48	L & T CR	M	6,538.00	Ft	2.12	16.18	23	77	0
48	L & T CR	L	6,024.00	Ft	1.95	7.28			
57	WEATHERING	L	308,881.00	SqFt	100	5.96			
Prairie Du Chien Runway 11-29 Section 20									
Distress	Description	Severity	Quantity	Units	Density	Deduct	% of Distress Deduct		
							Load	Climate	Other
48	L & T CR	M	142.00	Ft	1.46	13.43			
48	L & T CR	L	55.00	Ft	0.57	4.17	0	100	0
57	WEATHERING	L	9,696.00	SqFt	100	5.96			

Table C-19. Fort Atkinson (61C)—Runway 03/21

Fort Atkinson Runway 3-21 Section 10									
Distress	Description	Severity	Quantity	Units	Density	Deduct	% of Distress Deduct		
							Load	Climate	Other
41	ALLIGATOR CR	L	314.00	SqFt	0.14	7.33			
48	L & T CR	M	3,914.00	Ft	1.72	14.53	19	81	0
48	L & T CR	L	1,055.00	Ft	0.46	4			
48	L & T CR	H	19.00	Ft	0.01	7.5			
57	WEATHERING	L	199,500.00	SqFt	87.5	5.83			
Fort Atkinson Runway 3-21 Section 20									
Distress	Description	Severity	Quantity	Units	Density	Deduct	% of Distress Deduct		
							Load	Climate	Other
48	L & T CR	L	20.00	Ft	0.21	3.15			
52	RAVELING	M	3.00	SqFt	0.03	4	0	100	0
52	RAVELING	H	1.00	SqFt	0.01	6			
57	WEATHERING	L	9,692.00	SqFt	99.96	5.96			
Fort Atkinson Runway 3-21 Section 30									
Distress	Description	Severity	Quantity	Units	Density	Deduct	% of Distress Deduct		
							Load	Climate	Other
48	L & T CR	L	57.00	Ft	0.59	4.2			
57	WEATHERING	L	9,696.00	SqFt	100	5.96	0	100	0

Table C-20. Crandon (YSS)—Runway 12/30

Crandon Runway 12-30 Section 10									
Distress	Description	Severity	Quantity	Units	Density	Deduct	% of Distress Deduct		
							Load	Climate	Other
48	L & T CR	M	5,804.00	Ft	2.5	17.65			
48	L & T CR	L	5,973.00	Ft	2.57	8.92	0	100	0
57	WEATHERING	M	230,821.00	SqFt	99.24	20.29			
57	WEATHERING	H	1,773.00	SqFt	0.76	7.24			

Table C-21. Clintonville (CLI)—Runway 04/22

Clintonville Runway 4-22 Section 10									
Distress	Description	Severity	Quantity	Units	Density	Deduct	% of Distress Deduct		
							Load	Climate	Other
48	L & T CR	M	2,594.00	Ft	0.89	10.66			
48	L & T CR	L	771.00	Ft	0.26	3.46	0	100	0
57	WEATHERING	L	291,730.00	SqFt	100	5.96			

Table C-22. Oconto (OCQ)—Runway 11/29

Oconto Runway 11-29 Section 20									
Distress	Description	Severity	Quantity	Units	Density	Deduct	% of Distress Deduct		
							Load	Climate	Other
48	L & T CR	L	8,536.00	Ft	3.49	11.27			
57	WEATHERING	L	235,081.00	SqFt	96	5.93	0	100	0

Table C-23. Amery Municipal Airport (AHH)—Runway 18/36

Amery Runway 18-36, Section 10									
Distress	Description	Severity	Quantity	Units	Density	Deduct	% of Distress Deduct		
							Load	Climate	Other
48	L & T CR	M	7,710.00	Ft	2.57	17.93			
48	L & T CR	L	8,160.00	Ft	2.72	9.32	0	100	0
Amery Runway 18-36, Section 20									
Distress	Description	Severity	Quantity	Units	Density	Deduct	% of Distress Deduct		
							Load	Climate	Other
48	L & T CR	M	116.00	Ft	1.23	12.35			
48	L & T CR	L	126.00	Ft	1.34	5.7	0	100	0

Table C-24. Baraboo-Wisconsin Dells Regional (DLL)—Apron

Baraboo Apron 01 Section 10									
Distress	Description	Severity	Quantity	Units	Density	Deduct	% of Distress Deduct		
							Load	Climate	Other
48	L & T CR	M	431.00	Ft	0.44	7.83			
48	L & T CR	L	6,084.00	Ft	6.22	17.23	0	100	0
57	WEATHERING	M	88,422.00	SqFt	90.4	19.69			

Table C-25. Bloyer Field (Y72)—Apron and Taxiway A

Bloyer Apron 01 Section 10									
Distress	Description	Severity	Quantity	Units	Density	Deduct	% of Distress Deduct		
							Load	Climate	Other
48	L & T CR	M	49.00	Ft	0.12	4.02			
48	L & T CR	L	403.00	Ft	0.97	4.89	0	100	0
52	RAVELING	M	3.00	SqFt	0.01	4			
57	WEATHERING	L	41,296.00	SqFt	99.99	5.96			
Bloyer Taxiway A Section 10									
Distress	Description	Severity	Quantity	Units	Density	Deduct	% of Distress Deduct		
							Load	Climate	Other
48	L & T CR	L	40.00	Ft	0.37	3.82			
57	WEATHERING	L	10,730.00	SqFt	100	5.96	0	100	0

Table C-26. Cumberland Municipal Airport (UBE)—Apron, Runway 09/27, and Taxiway A

Cumberland Apron 01 Section 10									
Distress	Description	Severity	Quantity	Units	Density	Deduct	% of Distress Deduct		
41	ALLIGATOR CR	L	38.00	SqFt	0.05	7	Load	Climate	Other
48	L & T CR	M	1,450.00	Ft	1.92	15.39	21	79	0
48	L & T CR	L	2,671.00	Ft	3.54	11.41			
Cumberland Runway 9-27 Section 20									
Distress	Description	Severity	Quantity	Units	Density	Deduct	% of Distress Deduct		
48	L & T CR	M	2,377.00	Ft	0.78	10.08	Load	Climate	Other
48	L & T CR	L	23,284.00	Ft	7.67	19.79	0	100	0
Cumberland Taxiway A Section 10									
Distress	Description	Severity	Quantity	Units	Density	Deduct	% of Distress Deduct		
48	L & T CR	M	161.00	Ft	0.62	9.14	Load	Climate	Other
48	L & T CR	L	1,079.00	Ft	4.2	12.98	0	100	0

Table C-27. East Troy Municipal Airport (57C)—Runway 08/26 and Taxiway B

East Troy Runway 8-26 Section 10									
Distress	Description	Severity	Quantity	Units	Density	Deduct	% of Distress Deduct		
48	L & T CR	L	22,547.00	Ft	7.55	19.59	Load	Climate	Other
57	WEATHERING	L	298,760.00	SqFt	100	5.96	0	100	0
East Troy Taxiway B Section 10									
Distress	Description	Severity	Quantity	Units	Density	Deduct	% of Distress Deduct		
41	ALLIGATOR CR	M	399.00	SqFt	0.81	27.11	Load	Climate	Other
48	L & T CR	M	360.00	Ft	0.73	9.76	33	67	0
48	L & T CR	L	4,764.00	Ft	9.63	22.76			
57	WEATHERING	M	40,814.00	SqFt	82.48	19.07			
57	WEATHERING	L	8,669.00	SqFt	17.52	2.56			

Table C-28. Fond Du Lac County Airport (FLD)—Apron

Fond Du Lac Apron									
Distress	Description	Severity	Quantity	Units	Density	Deduct	% of Distress Deduct		
45	DEPRESSION	L	440.00	SqFt	0.32	1.82	Load	Climate	Other
48	L & T CR	M	694.00	Ft	0.51	8.37	0	96	4
48	L & T CR	L	3,816.00	Ft	2.8	9.54			
57	WEATHERING	M	135,881.00	SqFt	99.84	20.33			
57	WEATHERING	H	220.00	SqFt	0.16	4.01			

Table C-29. Park Falls Municipal Airport (PKF)—Runway 18/36

Park Falls Runway 18-36 Section 20									
Distress	Description	Severity	Quantity	Units	Density	Deduct	% of Distress Deduct		
48	L & T CR	M	2,218.00	Ft	1.15	12	Load	Climate	Other
48	L & T CR	L	6,236.00	Ft	3.25	10.68	0	100	0